



# Firestone



---

## AIR SPRING

REPLACEMENT GUIDE 2020

---

[firestoneip.com](http://firestoneip.com)

800-888-0650

# THE COMPLETE SOLUTION FROM THE ORIGINAL AIR SPRING



## TABLE OF CONTENTS

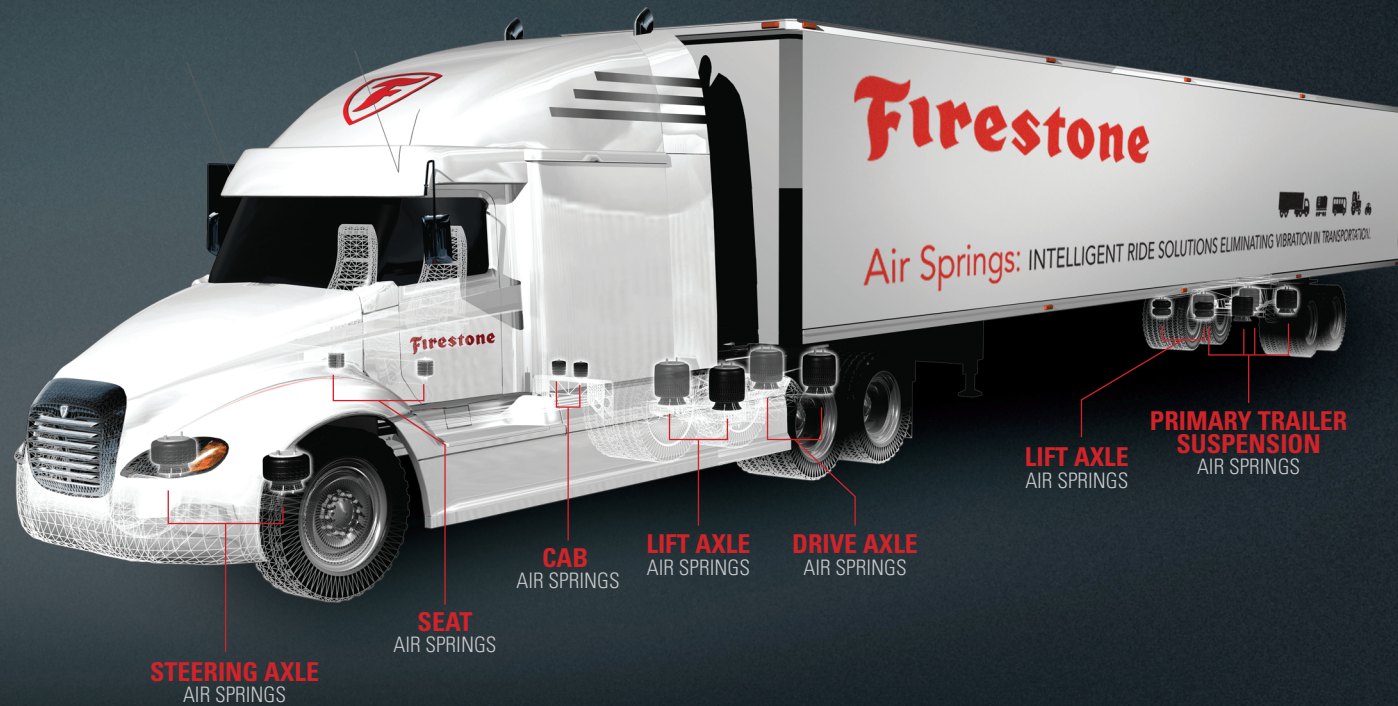

Airide™ springs were pioneered by Firestone and perfected over the last 80 years. Given the wide adoption of Airide springs on practically all truck and trailer manufacturers, **only Firestone offers the complete replacement solution.**



### COMPONENTS & PART DIAGRAMS

Introduction .....	4
Airide Spring Components .....	6
Airide Spring Styles & Identification .....	7
General Specifications .....	8
Alignment Definitions .....	9
PRIMARY TRUCK & TRAILER AXLE	
<b>1T Reversible Sleeve Springs</b> .....	<b>10</b>
Parts Tables .....	12
AUXILIARY / TAG AXLE	
<b>Convolute Springs</b> .....	<b>94</b>
Single Convolute .....	96
Double Convolute .....	98
Triple Convolute .....	119
CAB & SEAT	
<b>Sleeve Style Springs</b> .....	<b>128</b>
Parts Tables .....	130
STEERING AXLE	
<b>Sleeve Style Springs</b> .....	<b>148</b>
Parts Tables .....	150

### CROSS REFERENCES

PRIMARY TRUCK & TRAILER, AUXILIARY / TAG AXLE	
Manufacturer to Firestone No. ....	152
Goodyear Assembly No. to Firestone .....	182
Goodyear Bellows No. to Firestone .....	192
Contitech Assembly No. to Firestone .....	200
Bellows Index by Bellows No. ....	206
1T Bellows Index by C01 Bellows No. ....	210
Bellows Index by Size .....	216
PRIMARY TRUCK & TRAILER PISTON	
Index by Piston Component No. ....	220
Index by Piston Drawing No. ....	234
CAB & SEAT	
Index by Manufacturer .....	248
Index by Cap Drawing No. ....	250
Index by Piston Drawing No. ....	252
Index by Cap Component No. ....	254
Index by Piston Component No. ....	256
OE Suspension Index .....	258
All Parts Assembly Order No. Index .....	264
<b>WARRANTY AND MAINTENANCE</b>	
<b>Warranty</b> .....	<b>270</b>
Preventive Maintenance Checklist .....	273

# WHEN EVERYTHING RIDES ON IT, TRUST FIRESTONE



For over 80 years, Firestone has been the trusted partner of commercial trucks and trailers around the globe. With our industry experience, as well as our international customer base, you can trust Firestone's quality, reliability, and service.

**It's value for the long haul.**



## QUALITY

While air springs may appear simple, they are actually a highly sophisticated and complex product. Firestone Airide springs are engineered to meet the strictest standards, no matter where you are located. Our extensive experience utilizing high-strength fabric and rubber compounds allows us to provide you with the confidence of a long-lasting, trouble-free air spring. To support this confidence, Airide springs are rigorously tested to OEM requirements, as well as our own. **It's an obsession with quality you can only expect from a leader.**



## RELIABILITY

Firestone allows you to buy with confidence. We engineer and manufacture each product to provide years and thousands of miles of trouble-free service. OEMs trust Firestone's production and testing standards, which carries over into our aftermarket products. In fact, Firestone air springs often outlast other maintenance items on your suspension. With our industry-leading five-year warranty, we stand behind the durability and quality of our products. **Airide air springs will give you peace of mind on your journeys, no matter where they take you.**



## SERVICE

We not only pride ourselves on high-quality products, but also our commitment to serving our customers and the industry. Therefore, we have the extensive service arm that goes along with our global manufacturing footprint. As an organization, we consistently strive to serve our customers and the market as best as possible. Our mission is to support distributors and end customers with training and product identification help, such as this application guide, as well as any other replacement needs. **You can rely on Firestone as your service partner.**



1T Reversible Sleeve Example

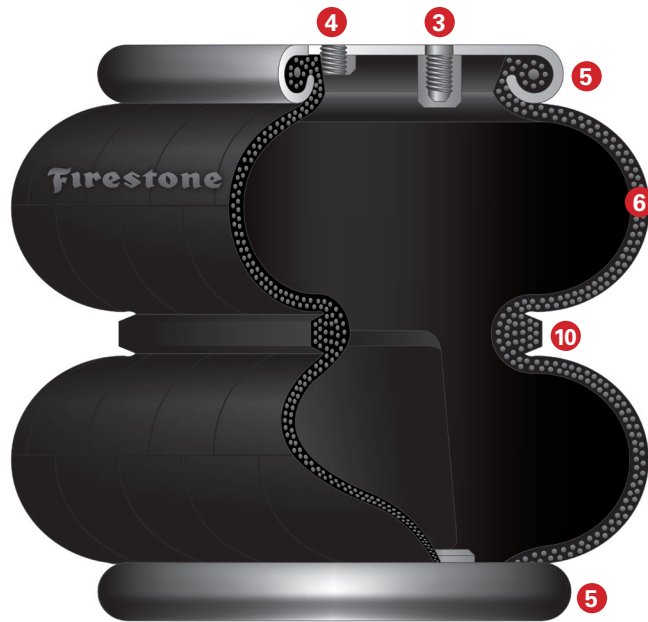

Double Convoluted Example

- 1. Stud**  
A permanent part of the bead plate assembly, used to attach the air spring to the suspension.
- 2. Combo Stud**  
Combination mounting stud and air fitting.
- 3. Blind Nut**  
A permanent part of the bead plate assembly, used to attach the air spring to the suspension.
- 4. Air Fitting Hole**  
A tapped hole that provides an air entrance for the part.
- 5. Bead Plate**  
Steel plate, permanently crimped to the bellows to form an airtight assembly.
- 6. Bellows**  
The air spring bellows is a flexible, airtight composite of rubber and reinforced fabric, which allows the assembly to roll up and down, providing an air-cushioned spring effect within the suspension.
- 7. Bumper (Optional)**  
A solid, molded rubber fail-safe device used on many suspension applications. Prevents excessive damage to vehicle and suspension in the case of sudden air pressure loss.
- 8. Piston**  
The lower section of the 1T and 1X style of air spring made from aluminum, steel, or fiber reinforced composite. Provides lower mounting arrangement for the air spring in the form of tapped holes or studs.
- 9. Piston Bolt**  
Attaches the piston to the bellows assembly. Extended on the bottom of the piston, in some cases, to serve as a means of attaching the spring to the suspension.
- 10. Girdle Hoop**  
A ring molded into the bellows of the convoluted type air spring.

**ASSEMBLY ORDER NUMBER & BELLOWS NUMBER**

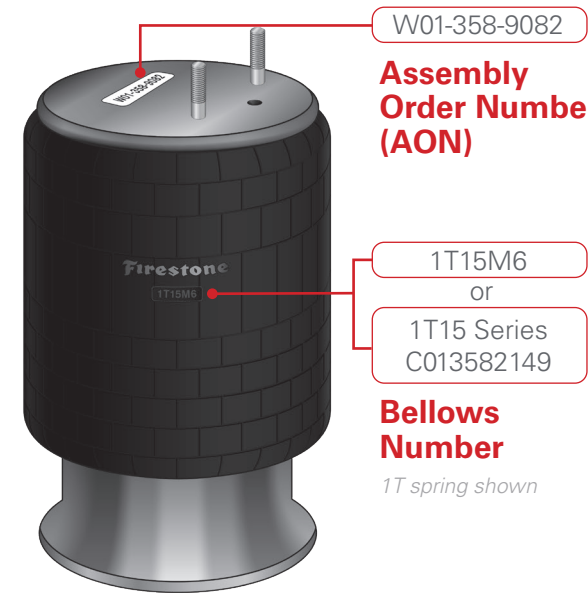

To identify an Airide spring for replacement, find the Assembly Order Number (AON) on the label adhered to the bead plate (e.g., W01-358-9082). This number is used for ordering purposes. Do not confuse this with the stamped 8-digit bead plate number. See page references below for detailed instructions on identifying your air spring.

For 1T and Convoluted springs, the bellows number is typically molded directly underneath the Firestone logo and tells exactly which bellows is needed.

1T spring samples:	Convoluted spring samples:
<ul style="list-style-type: none"> <li>• 1T15M6 or 1T19L7</li> <li>• 1T15 Series, C013582149</li> </ul>	<ul style="list-style-type: none"> <li>• 113, 20, or 312</li> </ul>

This number will help narrow your choice of assemblies to just a few.

Start by identifying your style of air spring by comparing to the illustrations below. Then, go to the appropriate section of this guide or the cross references for more information on determining the corresponding order numbers.

**AIR SPRING STYLES**



**1T REVERSIBLE SLEEVE**  
PRIMARY TRUCK & TRAILER AXLE  
PAGE 10



**CONVOLUTED**  
AUXILIARY / TAG AXLE  
PAGE 94



**SLEEVE**  
CAB & SEAT  
PAGE 128



**SLEEVE**  
STEERING AXLE  
PAGE 148

Want an online resource for air spring identification? Visit:  
[firestoneip.com/product-search](http://firestoneip.com/product-search)  
to use our online air spring identification tool.

FASTENER TIGHTENING SPECIFICATIONS		
Description	Size	Torque (lb-ft)
Bead ring nuts on bolts	5/16-24	17-22
Bead ring nuts on bolts	3/8-24	28-32
Bolts in blind nuts in bead plates	3/8-16	15-20
End of adapter studs in blind nut	3/8-16	15-20
Nut on end of adapter stud	1/2-13	25-30
Studs on bead plates or blind nuts	1/2-13 or 1/2-20 M12 x 1.75	25-30
Bolt to attach piston base to lower mounting surface	1/2-13	25-30
Nut on air entrance stud	3/4-16 M16 x 1.5 M20 x 1.5	40-45
Nut to an entrance stud	1 5/16-12UNF 1 1/4-12UNF	45-50
NPT air supply fitting	1/4 & up	17-22
Nut on end closure lower mounting	3/4-10	45-50

**Operational Cautions**

Air spring failure can be caused by a variety of situations, including internal or external rubbing, excessive heat, and overextension. For further details, refer to warranty section on page 270.

**Temperature/Pressure Range**

The ambient operating temperature range for standard vehicular air springs may vary. See the website for temperature ranges for individual parts by part number. The maximum pressure is 100 PSI.

**Bumpers**

In general, bumpers are used to support the vehicle weight to prevent damage to the flexible membrane during times when no air is in the system. They are also used as stops when the axle is raised by a lift unit. In applications that require frequent bumper contact, consult Firestone.

**Downstops and Upstops**

Positive stops in both directions (compression and extension) should always be used with Airide™ springs.

1. In **COMPRESSION**, the minimum height shown for each air spring is at, or slightly above the PINCH POINT of the bellows. Here is a #22 shown in the collapsed or “pinch point” condition:

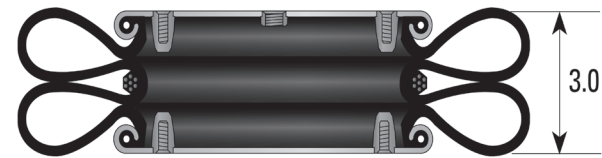

The bellows can be damaged if allowed to constantly bottom out as shown above; therefore, a downstop is required to prevent this. An external downstop can be something as simple as a steel block and should be sized at or slightly greater than the minimum height of the Airide spring. In our #22 example, the block would need to be at least 3.0 inches high. If an external downstop cannot be used, many parts are available with internal rubber bumpers.

2. In **EXTENSION**, an upstop is necessary to prevent the air spring from overextending. The reasons for this are two-fold:

- a) the life of the bellows may be reduced, and
  - b) the crimp may open up, allowing the bellows bead to blow out of the metal end closure.
- There are many ways to design-in an upstop, including shocks, chain, a cable or strap, contacting a metal shop, etc.

**Contaminates**

Shielding should be used to protect the bellows from exposure to hot metal, sand, petroleum base fluids, acids, etc. Please consult Firestone if you wish to know how the bellows will withstand a specific contaminant. (For liquids such as acids, it is important to know both concentration and temperature.)

**Storage**

The best storage environment is a dark, dry area at normal room temperature.

**Air Spring Alignment**

Alignment is based on the orientation of the lower bead plate or piston compared to the upper bead plate. Alignments other than those shown are noted in the bottom view.

BEAD PLATE TOP VIEW	BEAD PLATE OR PISTON BOTTOM VIEW	
	PARALLEL ALIGNMENT	45° ALIGNMENT

**WARNING**

DO NOT INFLATE ASSEMBLY WHEN IT IS UNRESTRICTED. ASSEMBLY MUST BE RESTRICTED BY SUSPENSION OR OTHER ADEQUATE STRUCTURE. DO NOT INFLATE BEYOND PRESSURES RECOMMENDED IN DESIGN LITERATURE (CONTACT FIRESTONE FOR INFORMATION). IMPROPER USE OR OVERINFLATION MAY CAUSE ASSEMBLY TO BURST, CAUSING PROPERTY DAMAGE OR SEVERE PERSONAL INJURY.



The Firestone 1T or Reversible Sleeve type spring is the most popular style used on suspensions.

READING THE PARTS TABLE

<b>1</b> BELLOWS <b>1T15M2</b>	<b>2</b> AON <b>W01-358-9105</b>	<b>7</b> C01-358-1131	<b>8</b> 12.79	<b>9</b> Composite
			<b>10</b> SERVICE ASSEMBLY <b>W01-358-0725</b>	<b>11</b> APPLICATIONS: Hendrickson Trailer S1245 Granning 5065 Ridewell 1003589105C Watson & Chalin AS-0015
	<b>3235</b>	<b>9550/ NAD-29456</b>	<b>6</b> ORDER NO. WC1-358-1652	<b>12</b> OBSOLETE: REPLACED BY W01-358-5508

**1. Bellows Number**

Identifies the bellows, normally molded directly underneath the Firestone logo.

**2. Assembly Order Number (AON)**

Located on the label adhered to the bead plate. This number is used for ordering purposes.

**3. Cross Section View**

Includes dimensional information in inches for **uninflated** diameter, maximum height, and collapsed height. A bumper, shown in black, and bumper drawing number is also referenced, if applicable (i.e., 3159).

**4. Bead Plate Top View**

Identifies dimensional information in inches, mounting attachments and the internal Firestone reference number for bead plate, stamped on bead plate top.

**5. Piston Bottom View**

Includes dimensional information in inches, mounting attachments and piston identification numbers.

**6. Piston Component Order Number**

The number used to order a replacement piston component, if applicable.

**7. Bellows Component Number**

If present, the C01-xxx-xxxx number identifies the Firestone internal bellows component, and can be referenced to specific AON applications.

**8. Assembly Weight**

Total weight of the assembly in pounds.

**9. Piston Material**

Aluminum, Steel, or Composite.

**10. Assembly Components**

Part numbers for sub-components associated with the assembly.

**11. Applications**

Vehicle and suspension manufacturers' part numbers for the particular Airide spring.

**12. Assembly Notes**

Important information if an assembly has been obsoleted and if there is an exact replacement part available, or if it has replaced other parts.

AIR SPRING IDENTIFICATION

**Assembly Order Number (AON)**

The quickest way to identify the air spring is to read the manufacturer or Firestone assembly order number on the label adhered to the bead plate. Do not confuse this with the stamped 8-digit bead plate number.

**Bellows Number**

If the AON is illegible, read the part number molded on the bellows, normally directly under the Firestone name. The bellows could be identified in two ways; 1) with the "1T15M2" call out, or 2) with a "1T15 Series" call out and a "C01" number identification (e.g. "C013581131"), which would narrow your search to a smaller group of AONs. Then, use the bead plate and piston combination to determine the final AON.

**Bead Plate**

Identify the 8-digit stamped bead plate number. Reference the last 4 digits to find a match. If the number is not legible, use the **bead plate diameter** measurement in this view to further distinguish between assemblies. In addition, verify the alignment of mounting attachments.

**Piston Bottom View**

Compare the **piston identification numbers**, molded inside the piston, to those shown in the "Piston Bottom View" to find a match. You may also reference the piston indexes on pages 220 and 234 to narrow your search.

**BOTTOM VIEW**

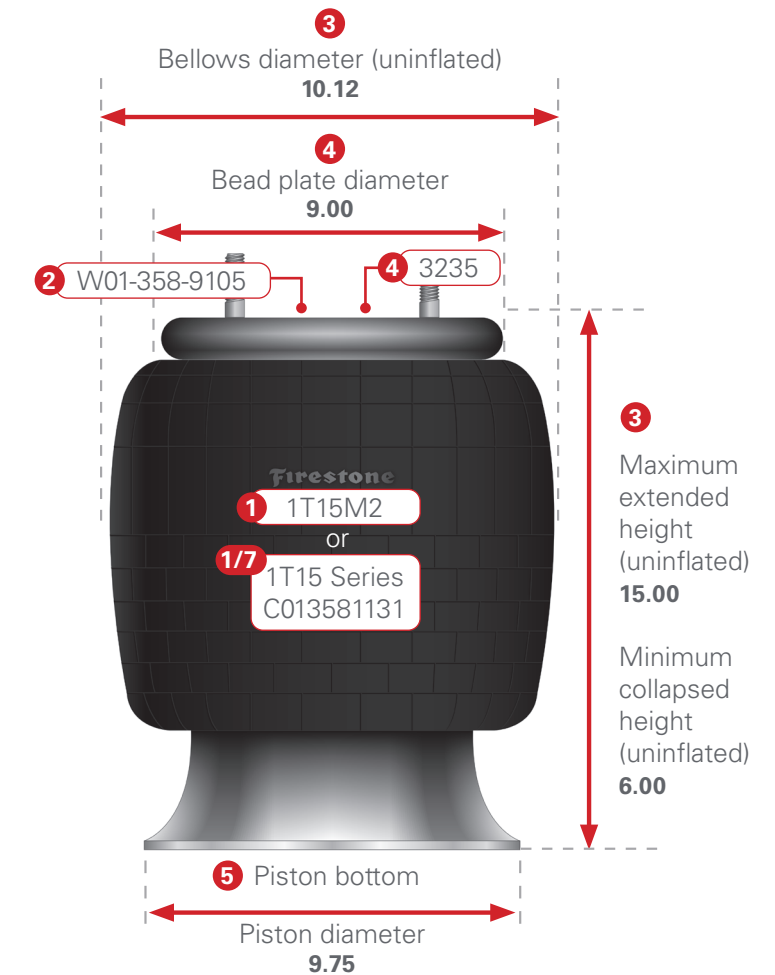
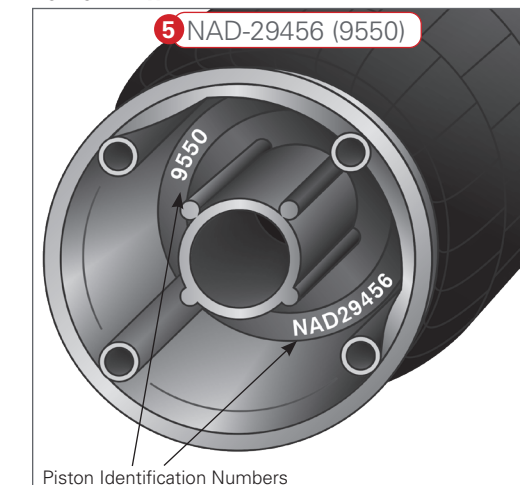

**Measure and Reference Cross Section View**

Should the bellows number be unreadable, the type can still be determined by measuring the **bellows diameter (uninflated)** and comparing this with the 1T styles in the Bellows Index by Size (page 216) until you find a match for the possible bellows. Then, measure the **maximum extended height**, as shown, and compare this with the "Cross Section View" of the parts tables for the general style of possible bellows (1T14, 1T15, 1T17, etc.). To determine if an **internal bumper** is present, measure the minimum collapsed height and compare it to the parts table.

BELLOWS <b>1T14C1</b>	AON <b>W01-358-2119</b>	C01-358-2112	5.76 Composite
<p>CROSS SECTION</p>	<p>BEAD PLATE TOP</p>	<p>PISTON BOTTOM</p>	<p>3093 9491/FIP-100744</p> <p><b>APPLICATIONS:</b> Granning 5122 Hendrickson Trailer S2394 Rowe Truck ASC1400HL Lift</p> <p>Order No. WC1-358-0609</p>

BELLOWS <b>1T14C1</b>	AON <b>W01-358-2120</b>	C01-358-2112	6.96 Aluminum
<p>CROSS SECTION</p>	<p>BEAD PLATE TOP</p>	<p>PISTON BOTTOM</p>	<p>3148 9651/NBD-11498</p> <p><b>APPLICATIONS:</b> Granning 5691 Granning 6104 (no stud) Rowe Truck ASCS2000 Lift Rowe Trailer ASCST2000</p> <p>Order No. WC1-358-9095</p>

BELLOWS <b>1T14C1</b>	AON <b>W01-358-2131</b>	C01-358-2112	5.58 Composite
<p>CROSS SECTION</p>	<p>BEAD PLATE TOP</p>	<p>PISTON BOTTOM</p>	<p>3140 9491/FIP-100744</p> <p><b>APPLICATIONS:</b> Kelderman</p> <p>Order No. WC1-358-0609</p>

BELLOWS <b>1T14C1</b>	AON <b>W01-358-5310</b>	C01-358-2112	6.28 Aluminum
<p>CROSS SECTION</p>	<p>BEAD PLATE TOP</p>	<p>PISTON BOTTOM</p>	<p>3079 9708/NBD-8626</p> <p><b>APPLICATIONS:</b> American Carrier 9003-001 Hendrickson Trailer S8832 Ridewell 1003585310C Circle R</p> <p>Order No. WC1-358-0600</p>

BELLOWS <b>1T14C1</b>	AON <b>W01-358-5311</b>	C01-358-2112	6.59 Aluminum
<p>CROSS SECTION</p>	<p>BEAD PLATE TOP</p>	<p>PISTON BOTTOM</p>	<p>3079 9708/NBD-8626</p> <p><b>APPLICATIONS:</b> Ridewell 1003585311C</p> <p>Order No. WC1-358-0600</p>

BELLOWS <b>1T14C1</b>	AON <b>W01-358-5323</b>	C01-358-2112	6.79 Aluminum
<p>CROSS SECTION</p>	<p>BEAD PLATE TOP</p>	<p>PISTON BOTTOM</p>	<p>3148 9708/NBD-8626</p> <p><b>APPLICATIONS:</b> Air Ax (Roelofs) Granning 7504 Ridewell 1003585323C</p> <p>Order No. WC1-358-0600</p>

BELLOWS <b>1T14C1</b>	AON <b>W01-358-5343</b>	C01-358-2112	6.33 Aluminum
<p>CROSS SECTION</p>	<p>BEAD PLATE TOP</p>	<p>PISTON BOTTOM</p>	<p>3079 9651/NBD-11498</p> <p><b>APPLICATIONS:</b> Iveco 504035755</p> <p>Order No. WC1-358-9095</p>

BELLOWS <b>1T14C3</b>	AON <b>W01-358-5405</b>	C01-358-2185	6.32 Aluminum
<p>CROSS SECTION</p>	<p>BEAD PLATE TOP</p>	<p>PISTON BOTTOM</p>	<p>3079 9708/NBD-8626</p> <p><b>APPLICATIONS:</b> Circle R Hendrickson Trailer S9346</p> <p>Order No. WC1-358-0600</p>

BELLOWS <b>1T14C3</b>	AON <b>W01-358-5406</b>	C01-358-2185	6.69 Aluminum
<p>CROSS SECTION</p>	<p>BEAD PLATE TOP</p>	<p>PISTON BOTTOM</p>	<p>3140 9708/NBD-8626</p> <p><b>APPLICATIONS:</b> Granning 1971</p> <p>Order No. WC1-358-0600</p>

BELLOWS <b>1T14C3</b>	AON <b>W01-358-5408</b>	C01-358-2185	6.26 Aluminum
<p>CROSS SECTION</p>	<p>BEAD PLATE TOP</p>	<p>PISTON BOTTOM</p>	<p>3096 9708/NBD-8626</p> <p><b>APPLICATIONS:</b> Jet Company</p> <p>Order No. WC1-358-0600</p> <p><b>OBSELETE: NO LONGER AVAILABLE</b></p>

**HARDWARE KEY**

- Bolt or Stud 1/2-13
- ⊗ Air Inlet 1/4 N.P.T.
- ⊙ Combination Stud/Air Inlet Stud Outside Thread is 3/4-16 Pistons
- ⊕ Exception to Standard Stud/Air Inlet Stud Inside Thread of 1/4 N.P.T.
- ▲ No Alignment Specified-Center Stud Mounting is Standard
- ⊖ Threaded Hole 3/8-16 Blind Nut on Bead Plates 1/2-13 Pistons

BELLOWS <b>1T14C3</b>	AON <b>W01-358-5410</b>	C01-358-2185	8.01	Aluminum
	3140 	9778/NAD-18053 	<b>APPLICATIONS:</b> Granning 2112 Watson & Chalin AS-0029 Ridewell 1003585410C	
CROSS SECTION	BEAD PLATE TOP	PISTON BOTTOM	Order No. WC1-358-0686	

BELLOWS <b>1T14C3</b>	AON <b>W01-358-5412</b>	C01-358-2185	8.20	Aluminum
	3079 	9778/NAD-18053 	<b>APPLICATIONS:</b> American Carrier 8003-011 Oshkosh Neway 90057057	
CROSS SECTION	BEAD PLATE TOP	PISTON BOTTOM	Order No. WC1-358-0686	

BELLOWS <b>1T14C3</b>	AON <b>W01-358-5414</b>	C01-358-2185	8.53	Aluminum
	3148 	9778/NAD-18053 	<b>APPLICATIONS:</b> Air AX (Roelofs) Ridewell 1003585414C	
CROSS SECTION	BEAD PLATE TOP	PISTON BOTTOM	Order No. WC1-358-0686	

BELLOWS <b>1T14C3</b>	AON <b>W01-358-5422</b>	C01-358-2185	7.04	Aluminum
	3079 	9708/NBD-8626 	<b>APPLICATIONS:</b> Circle R	
CROSS SECTION	BEAD PLATE TOP	PISTON BOTTOM	Order No. WC1-358-0600	

BELLOWS <b>1T14C3</b>	AON <b>W01-358-5423</b>	C01-358-2185	7.32	Aluminum
	3148 	9651/NBD-11498 	<b>APPLICATIONS:</b> Granning 5235 Granning 5307 (no stud) Rowe Truck ASC1500/ASC1500/ ASCS2000 Lift Rowe Trailer ASCT1500/ ASCST1500/ ASCST2000	
CROSS SECTION	BEAD PLATE TOP	PISTON BOTTOM	Order No. WC1-358-9095	

**HARDWARE KEY**

- Bolt or Stud 1/2-13
- ⊗ Air Inlet 1/4 N.P.T.
- ⊗ Combination Stud/Air Inlet Stud Outside Thread is 3/4-16 Pistons
- ⊗ Exception to Standard Stud/Air Inlet Stud Inside Thread of 1/4 N.P.T.
- ▲ No Alignment Specified-Center Stud Mounting is Standard
- ⊗ Threaded Hole 3/8-16 Blind Nut on Bead Plates 1/2-13 Pistons

BELLOWS <b>1T14C3</b>	AON <b>W01-358-5434</b>	C01-358-2185	7.43	Aluminum
	3148 	9708/NBD-8626 	<b>APPLICATIONS:</b> Granning 7765	
CROSS SECTION	BEAD PLATE TOP	PISTON BOTTOM	Order No. WC1-358-0600	

BELLOWS <b>1T14C3</b>	AON <b>W01-358-9478</b>	C01-358-2185	6.78	Composite
	3140 	9493/FIP-100743 	<b>APPLICATIONS:</b> Granning 6250	
CROSS SECTION	BEAD PLATE TOP	PISTON BOTTOM	Order No. WC1-358-0754	

BELLOWS <b>1T14C5</b>	AON <b>W01-358-5335</b>	C01-358-2114	8.81	Aluminum
	4161 	9620/FIP-103587 OR 9778/NAD-18053 	<b>APPLICATIONS:</b> General Coach	
CROSS SECTION	BEAD PLATE TOP	PISTON BOTTOM		

BELLOWS <b>1T14C5</b>	AON <b>W01-358-5336</b>	C01-358-2114	8.50	Aluminum
	3148 	9778/NAD-18053 	<b>TANK VALVE WC1-358-0009</b>	
CROSS SECTION	BEAD PLATE TOP	PISTON BOTTOM	Order No. WC1-358-0686	

BELLOWS <b>1T14C5</b>	AON <b>W01-358-5345</b>	C01-358-2114	8.59	Aluminum
	3079 	9620/FIP-103587 OR 9778/NAD-18053 	<b>APPLICATIONS:</b>	
CROSS SECTION	BEAD PLATE TOP	PISTON BOTTOM		



BELLOWS <b>1T14C5</b>	AON <b>W01-358-5354</b>	C01-358-2114	8.50	Aluminum
	3148 	9651/NBD-11498 	<b>APPLICATIONS:</b> Rowe Truck	
CROSS SECTION	BEAD PLATE TOP	PISTON BOTTOM	Order No. WC1-358-9095	

BELLOWS <b>1T14C5</b>	AON <b>W01-358-8868</b>	C01-358-2114	7.28	Aluminum
	3106 	9651/NBD-11498 	<b>APPLICATIONS:</b> Hendrickson 57965-2 (reuse old bracket) Supersedes Hendrickson 57839 Hendrickson 57920-2 w/bracket Includes Bracket 57966-2 (left) 57967-2 (right)	
CROSS SECTION	BEAD PLATE TOP	PISTON BOTTOM	Order No. WC1-358-9095	

BELLOWS <b>1T14C6</b>	AON <b>W01-358-5439</b>	C01-358-2192	10.33	Aluminum
	3148 	9754/NBD-11689 	<b>APPLICATIONS:</b> Link 1103-0500 Ultraride	
CROSS SECTION	BEAD PLATE TOP	PISTON BOTTOM	Order No. WC1-358-1603	

BELLOWS <b>1T14C6</b>	AON <b>W01-358-5730</b>	C01-358-2192	6.38	Composite
	4161 	9493 / FIP-100743 	<b>APPLICATIONS:</b>	
CROSS SECTION	BEAD PLATE TOP	PISTON BOTTOM		

BELLOWS <b>1T14C6</b>	AON <b>W01-358-8977</b>	C01-358-2192	10.36	Aluminum
	3148 	9754/NBD-11689 	<b>APPLICATIONS:</b> Granning 5301 General Coach Air Ax (Roelofs)	
CROSS SECTION	BEAD PLATE TOP	PISTON BOTTOM	Order No. WC1-358-1603	

BELLOWS <b>1T14C6</b>	AON <b>W01-358-8979</b>	C01-358-2192	10.24	Aluminum
	3148 	9754/NBD-11689 	<b>APPLICATIONS:</b> Granning 5553	
CROSS SECTION	BEAD PLATE TOP	PISTON BOTTOM	Order No. WC1-358-1603	

BELLOWS <b>1T14C7</b>	AON <b>W01-358-5426</b>	C01-358-2187	9.13	Aluminum
	3148 	9778 / NAD-18053 	<b>APPLICATIONS:</b> Granning 6117	
CROSS SECTION	BEAD PLATE TOP	PISTON BOTTOM	ORDER NO. WC1-358-0686	

BELLOWS <b>1T14C7</b>	AON <b>W01-358-5702</b>	C01-358-2187	10.29	Aluminum
	3148 	9754 / NBD-11689 	<b>APPLICATIONS:</b> Granning 8609	
CROSS SECTION	BEAD PLATE TOP	PISTON BOTTOM	ORDER NO. WC1-358-1603	

BELLOWS <b>1T14C7</b>	AON <b>W01-358-5710</b>	C01-358-2187	7.25	Aluminum
	3140 	6853/FIP-103894 OR 9708/NBD-8626 	<b>APPLICATIONS:</b>	
CROSS SECTION	BEAD PLATE TOP	PISTON BOTTOM	Order No. WC1-358-0600	
<b>OBSELETE: NO LONGER AVAILABLE</b>				

BELLOWS <b>1T14C7</b>	AON <b>W01-358-5712</b>	C01-358-2187	7.14	Aluminum
	3079 	9708 / NBD-8626 	<b>APPLICATIONS:</b> Capacity of Texas	
CROSS SECTION	BEAD PLATE TOP	PISTON BOTTOM	ORDER NO. WC1-358-0600	

**HARDWARE KEY**  
 ● Bolt or Stud 1/2-13      ⊗ Air Inlet 1/4 N.P.T.  
 ⊗ Combination Stud/Air Inlet Stud Outside Thread is 3/4-16 Pistons  
 ⊗ Exception to Standard Stud/Air Inlet Stud Inside Thread of 1/4 N.P.T.  
 ▲ No Alignment Specified-Center Stud Mounting is Standard  
 ⊕ Threaded Hole 3/8-16 Blind Nut on Bead Plates 1/2-13 Pistons

PRIMARY TRUCK & TRAILER AXLE

BELLOWS <b>1T14C8</b>	AON <b>W01-358-5429</b>	C01-358-2188	10.59	Aluminum
	3079 	9754/NBD-11689 	<b>APPLICATIONS:</b> Silent Drive	
CROSS SECTION	BEAD PLATE TOP	PISTON BOTTOM	ORDER NO. WC1-358-1603	

BELLOWS <b>1T14CB1</b>	AON <b>W01-358-5297</b>	C01-358-0018	5.83	Composite
	4159 	9491/FIP-100744 	<b>APPLICATIONS:</b> Watson & Chalin AS-0106	
CROSS SECTION	BEAD PLATE TOP	PISTON BOTTOM	<b>OBSOLETE: NO LONGER AVAILABLE</b>	
Order No. WC1-358-0609				

BELLOWS <b>1T14CB1</b>	AON <b>W01-358-5298</b>	C01-358-0018	5.70	Composite
	3148 	9493 / FIP-100743 	<b>APPLICATIONS:</b> Gillig Low Floor front 08-372-09-000N	
CROSS SECTION	BEAD PLATE TOP	PISTON BOTTOM	ORDER NO. WC1-358-0754	

BELLOWS <b>1T14CB1</b>	AON <b>W01-358-5319</b>	C01-358-0018	6.51	Composite
	3101 	9493/FIP-100743 	<b>APPLICATIONS:</b> Monaco Coach 8618	
CROSS SECTION	BEAD PLATE TOP	PISTON BOTTOM	ORDER NO. WC1-358-0754	

BELLOWS <b>1T14CB1</b>	AON <b>W01-358-5379</b>	C01-358-0018	6.29	Composite
	4159 	9491/FIP-100744 	<b>APPLICATIONS:</b>	
CROSS SECTION	BEAD PLATE TOP	PISTON BOTTOM	ORDER NO. WC1-358-0609	

BELLOWS <b>1T14CB1</b>	AON <b>W01-358-8992</b>	C01-358-0018	5.79	Composite
	3148 	9491/FIP-100744 	<b>APPLICATIONS:</b> Ridewell 1003588992C	
CROSS SECTION	BEAD PLATE TOP	PISTON BOTTOM	ORDER NO. WC1-358-0609	

BELLOWS <b>1T14CB1</b>	AON <b>W01-358-8997</b>	C01-358-0018	5.80	Composite
	3148 	9491/FIP-100744 	<b>APPLICATIONS:</b> Holland (Neway) 90557034 90557029 Watson & Chalin (AS-0026) Ridewell 1003588997C Silent Drive	
CROSS SECTION	BEAD PLATE TOP	PISTON BOTTOM	ORDER NO. WC1-358-0609	

BELLOWS <b>1T15CCR6</b>	AON <b>W01-358-8184</b>	C01-358-2276	20.28	Steel
	3253 	9645/NAD-31622 	<b>BRACKET WC1-358-3887</b>	
CROSS SECTION	BEAD PLATE TOP	PISTON BOTTOM	<b>APPLICATIONS:</b> Neway 90557290 (RL228, KL230) Neway 90557308 (Same except piston stud length 1.5 W01-358-8182)	

BELLOWS <b>1T15DR5.5</b>	AON <b>W01-358-8525</b>	C01-358-1150	18.07	Steel
	3235 	9639 / NAD-37120 	<b>APPLICATIONS:</b>	
CROSS SECTION	BEAD PLATE TOP	PISTON BOTTOM		

BELLOWS <b>1T15L1.5</b>	AON <b>W01-358-9422</b>	C01-358-2184	9.65	Composite
	3267 	9571/NAD-18130 	<b>APPLICATIONS:</b> Kenworth K303-6 Kenworth K303-14 Kenworth K303-15 (Airglide 100) older version with no bracket	
CROSS SECTION	BEAD PLATE TOP	PISTON BOTTOM	ORDER NO. WC1-358-0646	

**HARDWARE KEY**

- Bolt or Stud 1/2-13
- ⊗ Air Inlet 1/4 N.P.T.
- ⊗ Combination Stud/Air Inlet Stud Outside Thread is 3/4-16 Pistons
- ⊗ Exception to Standard Stud/Air Inlet Stud Inside Thread of 1/4 N.P.T.
- ▲ No Alignment Specified-Center Stud Mounting is Standard
- ⊗ Threaded Hole 3/8-16 Blind Nut on Bead Plates 1/2-13 Pistons

<b>BELLOWS 1T15L1.5</b>	<b>AON W01-358-9584</b>	C01-358-2020 12.07 Composite
	<p><b>BRACKET WC1-358-3887</b></p> <p><b>APPLICATIONS:</b> Neway 90557250 (replaces W01-675-9613, 90557224-flush fitting)</p>	

<b>BELLOWS 1T15L1.5</b>	<b>AON W01-358-9616</b>	C01-358-2184 11.23 Composite
	<p><b>BRACKET WC1-358-3893</b></p> <p><b>APPLICATIONS:</b> Kenworth K-303-16 (Airglide 100)</p>	

<b>BELLOWS 1T15L2</b>	<b>AON W01-358-8897</b>	C01-358-2182 11.80 Composite
	<p><b>APPLICATIONS:</b> Monaco 1804591</p>	

<b>BELLOWS 1T15L2</b>	<b>AON W01-358-8901</b>	C01-358-2182 11.56 Composite
	<p><b>APPLICATIONS:</b> Ridewell 1003588901C</p>	

<b>BELLOWS 1T15L2</b>	<b>AON W01-358-9376</b>	C01-358-2182 11.84 Composite
	<p><b>APPLICATIONS:</b> Monaco Coach 8619 Monaco Coach W01-358-8897 with 3/4" NPT</p>	

**HARDWARE KEY**

- Bolt or Stud 1/2-13
- ⊗ Air Inlet 1/4 N.P.T.
- ⊗ Combination Stud/Air Inlet Stud Outside Thread is 3/4-16 Pistons
- ⊗ Exception to Standard Stud/Air Inlet Stud Inside Thread of 1/4 N.P.T.
- ▲ No Alignment Specified-Center Stud Mounting is Standard
- ⊗ Threaded Hole 3/8-16 Blind Nut on Bead Plates 1/2-13 Pistons

<b>BELLOWS 1T15L2</b>	<b>AON W01-358-9387</b>	C01-358-2182 10.40 Composite
	<p><b>APPLICATIONS:</b> Ridewell 1003589387C</p>	

<b>BELLOWS 1T15L2</b>	<b>AON W01-358-9445</b>	C01-358-2182 14.26 Aluminum
	<p><b>APPLICATIONS:</b> Ridewell 1003589445C REPLACEMENT PISTON COMES WITHOUT STUDS</p>	

<b>BELLOWS 1T15L2</b>	<b>AON W01-358-9447</b>	C01-358-2182 14.06 Aluminum
	<p><b>APPLICATIONS:</b> Ridewell 1003589447C</p>	

<b>BELLOWS 1T15L2</b>	<b>AON W01-358-9448</b>	C01-358-2182 19.98 Aluminum
	<p><b>APPLICATIONS:</b> Ridewell 1003589448C Foretravel Inc. REPLACEMENT PISTON COMES WITHOUT STUDS</p>	

<b>BELLOWS 1T15L2</b>	<b>AON W01-358-9457</b>	C01-358-2182 14.00 Aluminum
	<p><b>APPLICATIONS:</b> Ridewell 1003589457C REPLACEMENT PISTON COMES WITHOUT STUDS</p>	

BELLOWS <b>1T15L2</b>	AON <b>W01-358-9459</b>	C01-358-2182	13.88	Aluminum
<p>CROSS SECTION</p>	<p>BEAD PLATE TOP</p>	<p>PISTON BOTTOM</p>	<p><b>APPLICATIONS:</b> Ridewell 1003589459C ArvinMeritor A-2258-U-1451 RFA23ER-RV</p>	
	3235	9659/ NBD-10472	ORDER NO. WC1-358-0683	

BELLOWS <b>1T15L2</b>	AON <b>W01-358-9477</b>	C01-358-2182	13.72	Aluminum
<p>CROSS SECTION</p>	<p>BEAD PLATE TOP</p>	<p>PISTON BOTTOM</p>	<p><b>APPLICATIONS:</b> Ridewell 1003589477C</p>	
	3220	9659/ NBD-10472	ORDER NO. WC1-358-0683	

BELLOWS <b>1T15L2</b>	AON <b>W01-358-9551</b>	C01-358-2182	10.56	Composite
<p>CROSS SECTION</p>	<p>BEAD PLATE TOP</p>	<p>PISTON BOTTOM</p>	<p><b>APPLICATIONS:</b> Roadmaster</p> <p><b>OBSOLETE: NO LONGER AVAILABLE</b></p>	
	3220	9571/NAD-18130	Order No. WC1-358-0646	

BELLOWS <b>1T15L2</b>	AON <b>W01-358-9562</b>	C01-358-2182	11.64	Composite
<p>CROSS SECTION</p>	<p>BEAD PLATE TOP</p>	<p>PISTON BOTTOM</p>	<p><b>APPLICATIONS:</b> Link 1103-0501 Liftable</p>	
	3235	9572/ NAD-18161	ORDER NO. WC1-358-0683	

BELLOWS <b>1T15L4</b>	AON <b>W01-358-8647</b>	C01-358-2176	11.31	Composite
<p>CROSS SECTION</p>	<p>BEAD PLATE TOP</p>	<p>PISTON BOTTOM</p>	<p><b>APPLICATIONS:</b></p>	
	3271	9549/ NAD-29454	ORDER NO. WC1-358-1616	

BELLOWS <b>1T15L4</b>	AON <b>W01-358-8874</b>	C01-358-2176	11.36	Composite
<p>CROSS SECTION</p>	<p>BEAD PLATE TOP</p>	<p>PISTON BOTTOM</p>	<p><b>APPLICATIONS:</b></p>	
	3271	9549/ NAD-29454	ORDER NO. WC1-358-1616	

BELLOWS <b>1T15L4</b>	AON <b>W01-358-8916</b>	C01-358-2176	15.51	Aluminum
<p>CROSS SECTION</p>	<p>BEAD PLATE TOP</p>	<p>PISTON BOTTOM</p>	<p><b>APPLICATIONS:</b></p>	
	3313	9659/NBD-10472 OR 6778/FIP-103969	ORDER NO. WC1-358-0683	

BELLOWS <b>1T15L4</b>	AON <b>W01-358-8919</b>	C01-358-2176	12.95	Composite
<p>CROSS SECTION</p>	<p>BEAD PLATE TOP</p>	<p>PISTON BOTTOM</p>	<p><b>APPLICATIONS:</b> Ridewell 1003588919C</p>	
	3271	9549/NAD-29454	ORDER NO. WC1-358-1616	

BELLOWS <b>1T15L4</b>	AON <b>W01-358-8922</b>	C01-358-2176	13.64	Aluminum
<p>CROSS SECTION</p>	<p>BEAD PLATE TOP</p>	<p>PISTON BOTTOM</p>	<p><b>APPLICATIONS:</b> Granning 5492 Granning 5385 (no stud)</p>	
	3235	9659/ NBD-10472	ORDER NO. WC1-358-0683	

BELLOWS <b>1T15L4</b>	AON <b>W01-358-8941</b>	C01-358-2176	13.50	Aluminum
<p>CROSS SECTION</p>	<p>BEAD PLATE TOP</p>	<p>PISTON BOTTOM</p>	<p><b>APPLICATIONS:</b> Hendrickson 59031-2</p>	
	3004	9659/NBD-10472	Order No. WC1-358-0683	

**HARDWARE KEY**

- Bolt or Stud 1/2-13
- ⊗ Air Inlet 1/4 N.P.T.
- ⊗ Combination Stud/Air Inlet Stud Outside Thread is 3/4-16 Pistons
- ⊗ Exception to Standard Stud/Air Inlet Stud Inside Thread of 1/4 N.P.T.
- ▲ No Alignment Specified-Center Stud Mounting is Standard
- ⊗ Threaded Hole 3/8-16 Blind Nut on Bead Plates 1/2-13 Pistons

BELLOWS <b>1T15L4</b>	AON <b>W01-358-9391</b>	C01-358-2176	13.32	Aluminum
<p>CROSS SECTION      BEAD PLATE TOP      PISTON BOTTOM</p>	<p>3220      3822 / NBD-10378</p>	<p><b>APPLICATIONS:</b></p>		

BELLOWS <b>1T15L4</b>	AON <b>W01-358-9415</b>	C01-358-2176	15.70	Aluminum
<p>CROSS SECTION      BEAD PLATE TOP      PISTON BOTTOM</p>	<p>3264      9691/ NBD-14503</p>	<p><b>APPLICATIONS:</b> Kenworth K-303-5 REPLACEMENT PISTON COMES WITHOUT STUDS</p>		

BELLOWS <b>1T15L4</b>	AON <b>W01-358-9439</b>	C01-358-2176	14.50	Aluminum
<p>CROSS SECTION      BEAD PLATE TOP      PISTON BOTTOM</p>	<p>3271      9656 / NBD-10440</p>	<p><b>APPLICATIONS:</b> Waggoner's Truck Hagie Mfg.</p>		

BELLOWS <b>1T15L4</b>	AON <b>W01-358-9441</b>	C01-358-2176	15.10	Aluminum
<p>CROSS SECTION      BEAD PLATE TOP      PISTON BOTTOM</p>	<p>3271      9606 / NAD-35550</p>	<p><b>APPLICATIONS:</b></p>		

BELLOWS <b>1T15L4</b>	AON <b>W01-358-9469</b>	C01-358-2176	14.71	Composite
<p>CROSS SECTION      BEAD PLATE TOP      PISTON BOTTOM</p>	<p>3271      9490 / FIP-101012</p>	<p><b>APPLICATIONS:</b></p>		

**HARDWARE KEY**

- Bolt or Stud 1/2-13      ⊗ Air Inlet 1/4 N.P.T.
- ⊗ Combination Stud/Air Inlet Stud Outside Thread is 3/4-16 Pistons
- ⊗ Exception to Standard Stud/Air Inlet Stud Inside Thread of 1/4 N.P.T.
- ▲ No Alignment Specified-Center Stud Mounting is Standard
- ⊕ Threaded Hole 3/8-16 Blind Nut on Bead Plates 1/2-13 Pistons

BELLOWS <b>1T15L6</b>	AON <b>W01-358-9626</b>	C01-358-1039	13.36	Composite
<p>CROSS SECTION      BEAD PLATE TOP      PISTON BOTTOM</p>	<p>3306      9532/ NAD-29827</p>	<p><b>APPLICATIONS:</b> Hendrickson Trailer S23720</p>		

BELLOWS <b>1T15L6</b>	AON <b>W01-358-9749</b>	C01-358-2211	24.43	Composite
<p>CROSS SECTION      BEAD PLATE TOP      PISTON BOTTOM</p>	<p>3190      9585/FIP-101543</p>	<p><b>APPLICATIONS:</b></p>		

BELLOWS <b>1T15L9</b>	AON <b>W01-358-9560</b>	C01-358-2171	14.08	Composite
<p>CROSS SECTION      BEAD PLATE TOP      PISTON BOTTOM</p>	<p>3242      9530/ NAD-27809</p>	<p><b>APPLICATIONS:</b> Reyco 25396-01</p>		

BELLOWS <b>1T15LA(-1)</b>	AON <b>W01-358-9547</b>	C01-358-2003	11.00	Composite
<p>CROSS SECTION      BEAD PLATE TOP      PISTON BOTTOM</p>	<p>3509      9569/NAD-27754</p>	<p>BRACKET <b>WC1-358-3883</b></p> <p><b>APPLICATIONS:</b> Kenworth C81-1004 Airglide 200 5/5/03 or later Airglide 400</p>		

BELLOWS <b>1T15LA(-1)</b>	AON <b>W01-358-9617</b>	C01-358-2003	11.18	Composite
<p>CROSS SECTION      BEAD PLATE TOP      PISTON BOTTOM</p>	<p>3174      9569/NAD-27754</p>	<p>BRACKET <b>WC1-358-3892</b></p> <p><b>APPLICATIONS:</b> Kenworth K-303-18 (Airglide 200) - small air fitting - original design (1996 &amp; 1997 prod.) Replaced by K -303-22(9622)</p>		

<b>BELLOWS 1T15LA(-1)</b>	<b>AON W01-358-9622</b>	C01-358-2003 11.19 Composite
	<b>BRACKET WC1-358-3883</b>	<b>APPLICATIONS:</b> Kenworth K-303-22 (Airglide 200-1998 to 5/5/03) - (large air fitting with interconnected airsprings)
		Order No. WC1-358-1629

<b>BELLOWS 1T15LA0</b>	<b>AON W01-358-9541</b>	C01-358-2021 11.00 Composite
	<b>BRACKET WC1-358-3890</b>	<b>APPLICATIONS:</b> Kenworth C81-1005 Airglide 200 5/5/03 or later Airglide 460 Airglide 690
		Order No. WC1-358-1629

<b>BELLOWS 1T15LA0</b>	<b>AON W01-358-9618</b>	C01-358-2007 13.52 Composite
	<b>BRACKET WC1-358-3892</b>	<b>APPLICATIONS:</b> Kenworth K-303-19 (Airglide 200-46,000#) - small air fitting -1996 & 97 prod. Replaced by K-303-25(9625)
		Order No. WC1-358-1629

<b>BELLOWS 1T15LA0</b>	<b>AON W01-358-9625</b>	C01-358-2007 13.48 Composite
	<b>BRACKET WC1-358-3890</b>	<b>APPLICATIONS:</b> Kenworth K-303-25 (Airglide 200-46,000#, 1998 & later prod.)
		Order No. WC1-358-1629

<b>BELLOWS 1T15LA0</b>	<b>AON W01-358-9675</b>	C01-358-2021 11.63 Composite
	<b>BRACKET WC1-358-3890</b>	<b>APPLICATIONS:</b> Kenworth K-303-28 Airglide 200 Before 5/5/03
		Order No. WC1-358-1629

**HARDWARE KEY**

- Bolt or Stud 1/2-13
- ⊗ Air Inlet 1/4 N.P.T.
- ⊗ Combination Stud/Air Inlet Stud Outside Thread is 3/4-16 Pistons
- ⊗ Exception to Standard Stud/Air Inlet Stud Inside Thread of 1/4 N.P.T.
- ▲ No Alignment Specified-Center Stud Mounting is Standard
- ⊗ Threaded Hole 3/8-16 Blind Nut on Bead Plates 1/2-13 Pistons

<b>BELLOWS 1T15LB10</b>	<b>AON W01-358-9621</b>	C01-358-2018 14.53 Composite
	<b>APPLICATIONS:</b> Hendrickson Trailer S23613	
		ORDER NO. WC1-358-1619

<b>BELLOWS 1T15LC2.5</b>	<b>AON W01-358-9379</b>	C01-358-2179 13.63 Aluminum
	<b>APPLICATIONS:</b> Navistar (U-Haul) 1660694C-1	

<b>BELLOWS 1T15LC2.5</b>	<b>AON W01-358-9565</b>	C01-358-2179 11.81 Aluminum
	<b>APPLICATIONS:</b> Navistar 2027912C1 (GY 1R12-324)	

<b>BELLOWS 1T15LC2.5</b>	<b>AON W01-358-9566</b>	C01-358-2179 11.81 Aluminum
	<b>APPLICATIONS:</b> Navistar 1672401C1 (GY 1R12-204)	
		<b>OBSELETE: NO LONGER AVAILABLE</b>

<b>BELLOWS 1T15LC4.5</b>	<b>AON W01-358-9567</b>	C01-358-2166 14.12 Aluminum
	<b>APPLICATIONS:</b> Navistar 2027913C1 (GY 1R12-325)	
		<b>OBSELETE: NO LONGER AVAILABLE</b>

BELLOWS <b>1T15LC4.5</b>	AON <b>W01-358-9568</b>	C01-358-2166	14.54	Aluminum
			<b>APPLICATIONS:</b> Navistar 1675495C1 (GY 1R12-205)	

BELLOWS <b>1T15LC12</b>	AON <b>W01-358-9619</b>	C01-358-2170	16.15	Composite
			<b>APPLICATIONS:</b> Hendrickson Trailer S23614	

BELLOWS <b>1T15LP1.5</b>	AON <b>W01-358-8597</b>	C01-358-0106	14.61	Aluminum
			<b>APPLICATIONS:</b> Hendrickson Truck 65790-2	

BELLOWS <b>1T15LP2</b>	AON <b>W01-358-8959</b>	C01-358-0107	14.58	Composite
			<b>APPLICATIONS:</b> Reyco 20773-01	

BELLOWS <b>1T15LP2</b>	AON <b>W01-358-9554</b>	C01-M58-2212	10.96	Composite
			<b>APPLICATIONS:</b> Hendrickson 60716-2 Volvo 20462941	

**HARDWARE KEY**

- Bolt or Stud 1/2-13
- ⊗ Air Inlet 1/4 N.P.T.
- ⊗ Combination Stud/Air Inlet Stud Outside Thread is 3/4-16 Pistons
- ⊗ Exception to Standard Stud/Air Inlet Stud Inside Thread of 1/4 N.P.T.
- ▲ No Alignment Specified-Center Stud Mounting is Standard
- ⊗ Threaded Hole 3/8-16 Blind Nut on Bead Plates 1/2-13 Pistons

BELLOWS <b>1T15LP3</b>	AON <b>W01-358-8478</b>	C01-358-0093	13.00	Aluminum
			<b>APPLICATIONS:</b>	

BELLOWS <b>1T15LP3</b>	AON <b>W01-358-8492</b>	C01-358-0093	13.65	Composite
			<b>APPLICATIONS:</b>	

BELLOWS <b>1T15LP3</b>	AON <b>W01-358-9017</b>	C01-358-0093	11.68	Composite
			<b>APPLICATIONS:</b>	

BELLOWS <b>1T15LP3</b>	AON <b>W01-358-9049</b>	C01-358-0093	13.64	Composite
			<b>APPLICATIONS:</b> East Mfg. Granning 6252	

BELLOWS <b>1T15LP3</b>	AON <b>W01-358-9073</b>	C01-358-0093	15.86	Composite
			<b>APPLICATIONS:</b> Circle R Kenworth K-102-A Hendrickson Trailer S-7193 Ridewell 1003589073C	

BELLOWS <b>1T15LP3</b>	AON <b>W01-358-9285</b>	C01-358-0093 11.63 Composite
<p><b>APPLICATIONS:</b> Hendrickson Trailer S-7364 REPLACEMENT PISTON COMES WITHOUT STUDS</p> <p><b>OBSOLETE: NO LONGER AVAILABLE</b></p>		

BELLOWS <b>1T15LP3</b>	AON <b>W01-358-9290</b>	C01-358-0093 14.14 Composite
<p><b>APPLICATIONS:</b> American Carrier 8003-025 (supersedes 9234) Ridewell 1003589290C Peerless</p> <p>Order No. WC1-358-1659</p>		

BELLOWS <b>1T15LP3</b>	AON <b>W01-358-9539</b>	C01-358-0093 17.13 Composite
<p><b>APPLICATIONS:</b></p>		

BELLOWS <b>1T15LP3</b>	AON <b>W01-358-9587</b>	C01-358-0093 14.67 Aluminum
<p>BRACKET <b>WC1-358-3887</b></p> <p><b>APPLICATIONS:</b> Holland (Neway) 90557248 (replaces 90557220-1/2" NPT flush) - ref. W01-358-9597</p>		

BELLOWS <b>1T15LP3</b>	AON <b>W01-358-9592</b>	C01-358-0093 14.51 Composite
<p>Order No. WC1-358-1659</p> <p><b>APPLICATIONS:</b></p>		

BELLOWS <b>1T15LP3</b>	AON <b>W01-358-9595</b>	C01-358-0093 14.14 Composite
<p><b>APPLICATIONS:</b></p>		

BELLOWS <b>1T15LP3</b>	AON <b>W01-358-9597</b>	C01-358-0093 14.69 Aluminum
<p>BRACKET <b>WC1-358-3887</b></p> <p><b>APPLICATIONS:</b> Holland (Neway) 90557172 (AD-200) - ref. 90557220 90557248 (1/2" NPT)</p>		

BELLOWS <b>1T15LP3</b>	AON <b>W01-358-9599</b>	C01-358-0093 13.96 Aluminum
<p><b>APPLICATIONS:</b> Holland (Neway) 90557094 (ARD suspensions) - reference 90557128 (bead plate-3215) Holland (Neway) 90557128</p>		

BELLOWS <b>1T15LP3</b>	AON <b>W01-358-9652</b>	C01-358-0093 11.38 Composite
<p>Order No. WC1-358-1658</p> <p><b>APPLICATIONS:</b> Mack 57QL1115 Hendrickson Trailer S14147 Supersedes W01-358-9043</p>		

BELLOWS <b>1T15LP3</b>	AON <b>W01-358-9750</b>	C01-358-0093 10.43 Composite
<p><b>APPLICATIONS:</b></p>		

**HARDWARE KEY**

- Bolt or Stud 1/2-13
- ⊗ Air Inlet 1/4 N.P.T.
- ⊙ Combination Stud/Air Inlet Stud Outside Thread is 3/4-16 Pistons
- ⊙ Exception to Standard Stud/Air Inlet Stud Inside Thread of 1/4 N.P.T.
- ▲ No Alignment Specified-Center Stud Mounting is Standard
- ⊙ Threaded Hole 3/8-16 Blind Nut on Bead Plates 1/2-13 Pistons



BELLOWS <b>1T15LP3</b>	AON <b>W01-358-9953</b>	C01-358-0093	17.93	Aluminum
<p>CROSS SECTION      BEAD PLATE TOP      PISTON BOTTOM</p>	<p>3271      9567/NAD-35451</p>	<p><b>APPLICATIONS:</b> Air AX (Roelofs)</p>		

BELLOWS <b>1T15LP5</b>	AON <b>W01-358-8949</b>	C01-358-0095	12.82	Composite
<p>CROSS SECTION      BEAD PLATE TOP      PISTON BOTTOM</p>	<p>3235      9549/ NAD-29454</p>	<p><b>APPLICATIONS:</b> Holland (Neway) 90557150</p>		

BELLOWS <b>1T15LP5</b>	AON <b>W01-358-9291</b>	C01-358-0095	14.66	Composite
<p>CROSS SECTION      BEAD PLATE TOP      PISTON BOTTOM</p>	<p>3235      9540/ NAD-29818</p>	<p><b>APPLICATIONS:</b> Holland (Neway) 90557139 (RL196-17) (RL196A-17) - replaces 90557122 - originally 1T15M-4 bellows</p>		

BELLOWS <b>1T15LP5</b>	AON <b>W01-358-9293</b>	C01-358-0095	13.26	Composite
<p>CROSS SECTION      BEAD PLATE TOP      PISTON BOTTOM</p>	<p>3235      9544/NAD-29826</p>	<p><b>APPLICATIONS:</b> Holland (Neway) 90557120 (RL196-14, RL196A-14)</p>		

BELLOWS <b>1T15LP5</b>	AON <b>W01-358-9294</b>	C01-358-0095	11.38	Composite
<p>CROSS SECTION      BEAD PLATE TOP      PISTON BOTTOM</p>	<p>3235      9573/ NAD-18162</p>	<p><b>APPLICATIONS:</b> Holland (Neway) 90557127 (RL-196-12)</p>		

BELLOWS <b>1T15LP5</b>	AON <b>W01-358-9295</b>	C01-358-0095	13.16	Composite
<p>CROSS SECTION      BEAD PLATE TOP      PISTON BOTTOM</p>	<p>3235      9532/ NAD-29827</p>	<p><b>APPLICATIONS:</b> Holland (Neway) 90557121 (RL196-15 &amp; 16) (RL196A-15 &amp; 16)</p>		

BELLOWS <b>1T15M0</b>	AON <b>W01-358-8961</b>	C01-358-2139	10.08	Composite
<p>CROSS SECTION      BEAD PLATE TOP      PISTON BOTTOM</p>	<p>3003      9572/ NAD-18161</p>	<p><b>APPLICATIONS:</b> Reyco 23377-01</p>		

BELLOWS <b>1T15M0</b>	AON <b>W01-358-8963</b>	C01-358-2151	13.17	Aluminum
<p>CROSS SECTION      BEAD PLATE TOP      PISTON BOTTOM</p>	<p>3188      9655/ NBD-10439</p>	<p><b>APPLICATIONS:</b> Ridewell 1003588963C</p>		

BELLOWS <b>1T15M0</b>	AON <b>W01-358-8964</b>	C01-358-2139	11.64	Composite
<p>CROSS SECTION      BEAD PLATE TOP      PISTON BOTTOM</p>	<p>3210      9571/ NAD-18130</p>	<p><b>APPLICATIONS:</b> Reyco 21598-01</p>		

BELLOWS <b>1T15M0</b>	AON <b>W01-358-8971</b>	C01-358-2139	10.13	Composite
<p>CROSS SECTION      BEAD PLATE TOP      PISTON BOTTOM</p>	<p>3271      9573/ NAD-18162</p>	<p><b>APPLICATIONS:</b> Hendrickson 59484-2 (Blue Bird)</p>		

**HARDWARE KEY**

- Bolt or Stud 1/2-13
- ⊗ Air Inlet 1/4 N.P.T.
- ⊗ Combination Stud/Air Inlet Stud Outside Thread is 3/4-16 Pistons
- ⊗ Exception to Standard Stud/Air Inlet Stud Inside Thread of 1/4 N.P.T.
- ▲ No Alignment Specified-Center Stud Mounting is Standard
- ⊗ Threaded Hole 3/8-16 Blind Nut on Bead Plates 1/2-13 Pistons

PRIMARY TRUCK & TRAILER AXLE

BELLOWS <b>1T15M0</b>	AON <b>W01-358-9031</b>	C01-358-2139	12.96	Aluminum	
<p>CROSS SECTION</p>	<p>BEAD PLATE TOP</p>	<p>PISTON BOTTOM</p>	<p><b>APPLICATIONS:</b> Peerless 0550-00051</p> <p>ORDER NO. WC1-358-0663</p>		

BELLOWS <b>1T15M0</b>	AON <b>W01-358-9033</b>	C01-358-2139	13.36	Aluminum	
<p>CROSS SECTION</p>	<p>BEAD PLATE TOP</p>	<p>PISTON BOTTOM</p>	<p><b>APPLICATIONS:</b> Holland (Neway) 90557012 Mfg.SV.# Holland (Neway) 90044198</p> <p>ORDER NO. WC1-358-9454</p>		

BELLOWS <b>1T15M0</b>	AON <b>W01-358-9036</b>	C01-358-2139	13.40	Aluminum	
<p>CROSS SECTION</p>	<p>BEAD PLATE TOP</p>	<p>PISTON BOTTOM</p>	<p><b>APPLICATIONS:</b> Willmar</p> <p>ORDER NO. WC1-358-0663</p>		

BELLOWS <b>1T15M0</b>	AON <b>W01-358-9039</b>	C01-358-2151	13.44	Aluminum	
<p>CROSS SECTION</p>	<p>BEAD PLATE TOP</p>	<p>PISTON BOTTOM</p>	<p>SEVICE ASSEMBLY <b>W01-358-0702</b></p> <p><b>APPLICATIONS:</b> Hendrickson Trailer S2064/S11650 Holland (Neway) 90557001, 90557023, 90557085 Hutchens H-9424-01 R &amp; S Truck &amp; Body 1090218 Ridewell 1013589039C FabTek 101827 Sauer P50-734 Watson &amp; Chalin AS-0012</p> <p>ORDER NO. WC1-358-9454</p>		

BELLOWS <b>1T15M0</b>	AON <b>W01-358-9308</b>	C01-358-2139	13.03	Aluminum	
<p>CROSS SECTION</p>	<p>BEAD PLATE TOP</p>	<p>PISTON BOTTOM</p>	<p><b>APPLICATIONS:</b> Reyco 17360-01 Holland (Neway) 90557089 (remove bolt)</p> <p>ORDER NO. WC1-358-0663</p>		

BELLOWS <b>1T15M0</b>	AON <b>W01-358-9333</b>	C01-358-2139	12.75	Aluminum	
<p>CROSS SECTION</p>	<p>BEAD PLATE TOP</p>	<p>PISTON BOTTOM</p>	<p><b>APPLICATIONS:</b> Reyco 20437-01</p> <p>ORDER NO. WC1-358-0663</p> <p><b>OBSELETE: NO LONGER AVAILABLE</b></p>		

BELLOWS <b>1T15M0</b>	AON <b>W01-358-9334</b>	C01-358-2139	12.97	Aluminum	
<p>CROSS SECTION</p>	<p>BEAD PLATE TOP</p>	<p>PISTON BOTTOM</p>	<p><b>APPLICATIONS:</b> Ridewell 1003589334C</p> <p>ORDER NO. WC1-358-0663</p>		

BELLOWS <b>1T15M0.5</b>	AON <b>W01-358-8970</b>	C01-358-2193	10.59	Composite	
<p>CROSS SECTION</p>	<p>BEAD PLATE TOP</p>	<p>PISTON BOTTOM</p>	<p><b>APPLICATIONS:</b></p>		

BELLOWS <b>1T15M0.5</b>	AON <b>W01-358-9306</b>	C01-358-2193	11.34	Composite	
<p>CROSS SECTION</p>	<p>BEAD PLATE TOP</p>	<p>PISTON BOTTOM</p>	<p><b>APPLICATIONS:</b></p>		

BELLOWS <b>1T15M0.5</b>	AON <b>W01-358-9307</b>	C01-358-2190	10.14	Composite	
<p>CROSS SECTION</p>	<p>BEAD PLATE TOP</p>	<p>PISTON BOTTOM</p>	<p><b>APPLICATIONS:</b> Holland (Neway) 90557129 (AR-41, 45 &amp; 45-1) (plastic)</p> <p>ORDER NO. WC1-358-1634</p>		

**HARDWARE KEY**

- Bolt or Stud 1/2-13
- ⊗ Air Inlet 1/4 N.P.T.
- ⊗ Combination Stud/Air Inlet Stud Outside Thread is 3/4-16 Pistons
- ⊗ Exception to Standard Stud/Air Inlet Stud Inside Thread of 1/4 N.P.T.
- ▲ No Alignment Specified-Center Stud Mounting is Standard
- ⊗ Threaded Hole 3/8-16 Blind Nut on Bead Plates 1/2-13 Pistons

BELLOWS <b>1T15M2</b>	AON <b>W01-358-8195</b>	C01-358-1131	12.64	Composite
			<b>APPLICATIONS:</b>	

BELLOWS <b>1T15M2</b>	AON <b>W01-358-8197</b>	C01-358-1131	10.37	Composite
			<b>APPLICATIONS:</b> Holland (Neway) 90557230	

BELLOWS <b>1T15M2</b>	AON <b>W01-358-8198</b>	C01-358-1131	13.27	Composite
			<b>APPLICATIONS:</b> 90557229 (IFS-114) - (center stud used for locating in pre-assembly)	
<b>OBSELETE: NO LONGER AVAILABLE</b>				

BELLOWS <b>1T15M2</b>	AON <b>W01-358-8203</b>	C01-358-1131	13.06	Composite
			<b>APPLICATIONS:</b> Holland (Neway) 90557210 - (replaces W01-358-8987) Wabash Trailer ArvinMeritor 2258-C-1459	

BELLOWS <b>1T15M2</b>	AON <b>W01-358-8204</b>	C01-358-1131	10.43	Composite
			<b>APPLICATIONS:</b> Holland (Neway) 90557173 (RL196A-12) Holland (Neway) 90557223 Binkley Newlite (NS 190-16)	

BELLOWS <b>1T15M2</b>	AON <b>W01-358-8878</b>	C01-358-1131	11.87	Composite
			<b>APPLICATIONS:</b> Arvin Meritor A-2258-A-1483 (WCC Front RV)	

BELLOWS <b>1T15M2</b>	AON <b>W01-358-8931</b>	C01-M58-0020	15.80	Aluminum
			<b>APPLICATIONS:</b> John Deere	

BELLOWS <b>1T15M2</b>	AON <b>W01-358-8932</b>	C01-358-1131	13.81	Composite
			<b>APPLICATIONS:</b> Reyco 22241-01	
<b>OBSELETE: NO LONGER AVAILABLE</b>				

BELLOWS <b>1T15M2</b>	AON <b>W01-358-8938</b>	C01-358-1131	12.79	Composite
			<b>APPLICATIONS:</b>	

BELLOWS <b>1T15M2</b>	AON <b>W01-358-8991</b>	C01-358-1131	12.74	Composite
			<b>APPLICATIONS:</b> Reyco 17414-01	

**HARDWARE KEY**

- Bolt or Stud 1/2-13
- ⊗ Air Inlet 1/4 N.P.T.
- ⊗ Combination Stud/Air Inlet Stud Outside Thread is 3/4-16 Pistons
- ⊗ Exception to Standard Stud/Air Inlet Stud Inside Thread of 1/4 N.P.T.
- ▲ No Alignment Specified-Center Stud Mounting is Standard
- ⊗ Threaded Hole 3/8-16 Blind Nut on Bead Plates 1/2-13 Pistons

**PRIMARY TRUCK & TRAILER AXLE**  
1T REVERSIBLE SLEEVE SPRINGS



BELLOWS <b>1T15M2</b>	AON <b>W01-358-9053</b>	C01-358-1131	14.64	Aluminum
 CROSS SECTION	 BEAD PLATE TOP	 PISTON BOTTOM	<b>APPLICATIONS:</b> EZ Ride 8030192 Ridewell 1003589053C Fruehauf UCE-1304-2	
				ORDER NO. WC1-358-0652

BELLOWS <b>1T15M2</b>	AON <b>W01-358-9078</b>	C01-358-1131	14.04	Aluminum
 CROSS SECTION	 BEAD PLATE TOP	 PISTON BOTTOM	<b>APPLICATIONS:</b> Fruehauf UCB-9668-1 Fruehauf MFR-022355	
				ORDER NO. WC1-358-0658

BELLOWS <b>1T15M2</b>	AON <b>W01-358-9105</b>	C01-358-1131	12.80	Composite
 CROSS SECTION	 BEAD PLATE TOP	 PISTON BOTTOM	<b>APPLICATIONS:</b> Hendrickson Trailer S1245 Granning 5065 Ridewell 1003589105C Watson & Chalin AS-0015	
				ORDER NO. WC1-358-1652

BELLOWS <b>1T15M2</b>	AON <b>W01-358-9118</b>	C01-358-1131	14.29	Aluminum
 CROSS SECTION	 BEAD PLATE TOP	 PISTON BOTTOM	<b>APPLICATIONS:</b> Ridewell 1003589118C	
				ORDER NO. WC1-358-0652
				<b>OBSELETE: NO LONGER AVAILABLE</b>

BELLOWS <b>1T15M2</b>	AON <b>W01-358-9303</b>	C01-358-1131	13.22	Composite
 CROSS SECTION	 BEAD PLATE TOP	 PISTON BOTTOM	<b>APPLICATIONS:</b>	



**PRIMARY TRUCK & TRAILER AXLE**  
1T REVERSIBLE SLEEVE SPRINGS

BELLOWS <b>1T15M2</b>	AON <b>W01-358-9325</b>	C01-358-1131	13.64	Composite
 CROSS SECTION	 BEAD PLATE TOP	 PISTON BOTTOM	<b>APPLICATIONS:</b> Holland (Neway) 90557149	
				ORDER NO. WC1-358-1619

BELLOWS <b>1T15M2</b>	AON <b>W01-358-9339</b>	C01-358-1131	11.96	Composite
 CROSS SECTION	 BEAD PLATE TOP	 PISTON BOTTOM	<b>APPLICATIONS:</b> Hendrickson 56808-2 (class 6 Ford) Hendrickson 57150 RH Hendrickson 57140 LH - Remove new bracket and reuse old (class 6&7 GM)	
				ORDER NO. WC1-358-0647
				<b>OBSELETE: NO LONGER AVAILABLE</b>

BELLOWS <b>1T15M2</b>	AON <b>W01-358-9365</b>	C01-358-1131	12.45	Composite
 CROSS SECTION	 BEAD PLATE TOP	 PISTON BOTTOM	<b>APPLICATIONS:</b> Holland (Neway) 90557159	
				ORDER NO. WC1-358-0666

BELLOWS <b>1T15M2</b>	AON <b>W01-358-9366</b>	C01-358-1131	11.82	Composite
 CROSS SECTION	 BEAD PLATE TOP	 PISTON BOTTOM	<b>APPLICATIONS:</b> Holland (Neway) 90557160 Holland (Neway) 90557210 Holland (Neway) 90557225 Watson & Chalin AS-0054 Wabash Holland (Neway) 90557225	
				ORDER NO. WC1-358-1616

BELLOWS <b>1T15M2</b>	AON <b>W01-358-9807</b>	C01-358-1131	11.00	Composite
 CROSS SECTION	 BEAD PLATE TOP	 PISTON BOTTOM	<b>APPLICATIONS:</b> Spacer Options WC1-358-1690 WC1-358-1691 WC1-358-1692 (see specs for each following) Holland 90557372 50857000	
				Order No. WC1-358-1660

**HARDWARE KEY**

- Bolt or Stud 1/2-13
- ⊗ Air Inlet 1/4 N.P.T.
- ⊗ Combination Stud/Air Inlet Stud Outside Thread is 3/4-16 Pistons
- ⊗ Exception to Standard Stud/Air Inlet Stud Inside Thread of 1/4 N.P.T.
- ▲ No Alignment Specified-Center Stud Mounting is Standard
- ⊗ Threaded Hole 3/8-16 Blind Nut on Bead Plates 1/2-13 Pistons

PRIMARY TRUCK & TRAILER AXLE

BELLOWS <b>1T15M4</b>	AON <b>W01-358-0742</b>	C01-358-2145	10.54	N/A
			<b>APPLICATIONS:</b>	

BELLOWS <b>1T15M4</b>	AON <b>W01-358-8802</b>	C01-358-2145	12.04	Composite
			<b>APPLICATIONS:</b> Ridewell 1003588802C Holland (Neway) 90557170	

BELLOWS <b>1T15M4</b>	AON <b>W01-358-8803</b>	C01-358-2145	13.09	Composite
			<b>APPLICATIONS:</b> Ridewell 1003588803C Holland (Neway) 90557194 (Dock-Mate)	

BELLOWS <b>1T15M4</b>	AON <b>W01-358-8805</b>	C01-358-2145	16.18	Aluminum
			<b>APPLICATIONS:</b> Ridewell 1003588805C	

BELLOWS <b>1T15M4</b>	AON <b>W01-358-8806</b>	C01-358-2145	14.00	Aluminum
			<b>APPLICATIONS:</b> Ridewell 1003588806C	

BELLOWS <b>1T15M4</b>	AON <b>W01-358-8810</b>	C01-358-2145	15.03	Aluminum
			<b>APPLICATIONS:</b> Hagie	

BELLOWS <b>1T15M4</b>	AON <b>W01-358-8813</b>	C01-358-2145	12.62	Composite
			<b>APPLICATIONS:</b> Kenworth C81-1003 Airglide 380 Peterbilt C81-6000 Flex Air	

BELLOWS <b>1T15M4</b>	AON <b>W01-358-8816</b>	C01-358-2145	13.19	Composite
			<b>APPLICATIONS:</b> Hendrickson 60929-2	

BELLOWS <b>1T15M4</b>	AON <b>W01-358-8817</b>	C01-358-2145	13.46	Composite
			<b>APPLICATIONS:</b> Hendrickson 60925-2	

BELLOWS <b>1T15M4</b>	AON <b>W01-358-9010</b>	C01-358-2145	16.14	Aluminum
			<b>APPLICATIONS:</b> Ridewell 1003589010C (replaces 9064) Reyco 12928-01 Hendrickson Trailer S2827 Hendrickson Trailer S11566 (remove bolt) Watson & Chalin AS-0044	

**HARDWARE KEY**  
 ● Bolt or Stud 1/2-13      ⊗ Air Inlet 1/4 N.P.T.  
 ⊗ Combination Stud/Air Inlet Stud Outside Thread is 3/4-16 Pistons  
 ⊗ Exception to Standard Stud/Air Inlet Stud Inside Thread of 1/4 N.P.T.  
 ▲ No Alignment Specified-Center Stud Mounting is Standard  
 ⊕ Threaded Hole 3/8-16 Blind Nut on Bead Plates 1/2-13 Pistons

BELLOWS <b>1T15M4</b>	AON <b>W01-358-9056</b>	C01-358-2145	13.65	Aluminum
<p>CROSS SECTION</p>	<p>BEAD PLATE TOP</p>	<p>PISTON BOTTOM</p>	<p><b>APPLICATIONS:</b> DAF 656991</p>	

BELLOWS <b>1T15M4</b>	AON <b>W01-358-9059</b>	C01-358-2145	16.32	Aluminum
<p>CROSS SECTION</p>	<p>BEAD PLATE TOP</p>	<p>PISTON BOTTOM</p>	<p><b>APPLICATIONS:</b> Hutchens H-1913-1</p>	

BELLOWS <b>1T15M4</b>	AON <b>W01-358-9069</b>	C01-358-2145	14.23	Composite
<p>CROSS SECTION</p>	<p>BEAD PLATE TOP</p>	<p>PISTON BOTTOM</p>	<p><b>APPLICATIONS:</b> Peterbilt 03-02456 Peterbilt 03-04759 Peterbilt 03-01649 Peterbilt 03-06746 Peterbilt 03-07112 Peterbilt 03-02038 (Air-Trac) MFG.SV# Peterbilt 03-10042</p>	

BELLOWS <b>1T15M4</b>	AON <b>W01-358-9070</b>	C01-358-2145	15.25	Aluminum
<p>CROSS SECTION</p>	<p>BEAD PLATE TOP</p>	<p>PISTON BOTTOM</p>	<p><b>APPLICATIONS:</b> Holland (Neway) 90557038 Holland (Neway) 90557090 (AR-90-1-12) Silent Drive</p>	

BELLOWS <b>1T15M4</b>	AON <b>W01-358-9071</b>	C01-358-2145	16.08	Aluminum
<p>CROSS SECTION</p>	<p>BEAD PLATE TOP</p>	<p>PISTON BOTTOM</p>	<p><b>APPLICATIONS:</b> Fab Tek (West Unit) 101357 Ridewell 1003589071C Pioneer Trailer</p>	

BELLOWS <b>1T15M4</b>	AON <b>W01-358-9335</b>	C01-358-2145	12.34	Composite
<p>CROSS SECTION</p>	<p>BEAD PLATE TOP</p>	<p>PISTON BOTTOM</p>	<p>BRACKET <b>WC1-358-3903</b></p> <p><b>APPLICATIONS:</b> Hendrickson 56917 - 1 &amp; 2 (Class6&amp;7 Freightliner) -ref.56916 (W01-358-9284) Superseded</p>	

BELLOWS <b>1T15M4</b>	AON <b>W01-358-9336</b>	C01-358-2145	13.38	Composite
<p>CROSS SECTION</p>	<p>BEAD PLATE TOP</p>	<p>PISTON BOTTOM</p>	<p><b>APPLICATIONS:</b> Watson &amp; Chalin AS-0053</p>	

BELLOWS <b>1T15M4</b>	AON <b>W01-358-9467</b>	C01-358-2145	18.58	Composite
<p>CROSS SECTION</p>	<p>BEAD PLATE TOP</p>	<p>PISTON BOTTOM</p>	<p><b>APPLICATIONS:</b> Ridewell 1003589467C</p> <p><b>OBSELETE: NO LONGER AVAILABLE</b></p>	

BELLOWS <b>1T15M4</b>	AON <b>W01-358-9482</b>	C01-358-2145	14.91	Composite
<p>CROSS SECTION</p>	<p>BEAD PLATE TOP</p>	<p>PISTON BOTTOM</p>	<p>BRACKET <b>WC1-358-3887</b></p> <p><b>APPLICATIONS:</b> Holland (Neway) 90557161 (AD200-7) (Gillig) - ref. W01-358-9585 (1/2" NPT)</p>	

BELLOWS <b>1T15M4</b>	AON <b>W01-358-9484</b>	C01-358-2145	12.87	Composite
<p>CROSS SECTION</p>	<p>BEAD PLATE TOP</p>	<p>PISTON BOTTOM</p>	<p><b>APPLICATIONS:</b> Holland (Neway) 90557158</p>	

**HARDWARE KEY**

- Bolt or Stud 1/2-13
- ⊗ Air Inlet 1/4 N.P.T.
- ⊗ Combination Stud/Air Inlet Stud Outside Thread is 3/4-16 Pistons
- ⊗ Exception to Standard Stud/Air Inlet Stud Inside Thread of 1/4 N.P.T.
- ▲ No Alignment Specified-Center Stud Mounting is Standard
- ⊗ Threaded Hole 3/8-16 Blind Nut on Bead Plates 1/2-13 Pistons

PRIMARY TRUCK & TRAILER AXLE

BELLOWS <b>1T15M4</b>	AON <b>W01-358-9507</b>	C01-358-2145	16.23	Aluminum
			BRACKET <b>WC1-358-3887</b>	
<b>APPLICATIONS:</b> Holland (Neway) 90557313 ORDER NO. WC1-358-0651				

BELLOWS <b>1T15M4</b>	AON <b>W01-358-9585</b>	C01-358-2145	15.41	Composite
			BRACKET <b>WC1-358-3887</b>	
<b>APPLICATIONS:</b> Holland (Neway) 90557247 (replaces 90557219-flush fitting) - ref.W01-358-9482 <b>OBSELETE: NO LONGER AVAILABLE</b> ORDER NO. WC1-358-1616				

BELLOWS <b>1T15M4</b>	AON <b>W01-358-9697</b>	C01-358-2145	13.25	Composite
			BRACKET <b>WC1-358-3887</b>	
<b>APPLICATIONS:</b> Holland 90557329 ORDER NO. WC1-358-1619				

BELLOWS <b>1T15M4</b>	AON <b>W01-358-9797</b>	C01-358-2145	13.86	Aluminum
			BRACKET <b>WC1-358-3887</b>	
<b>APPLICATIONS:</b> Ridewell 1003589797C ORDER NO. WC1-358-0652				

BELLOWS <b>1T15M4</b>	AON <b>W01-358-9978</b>	C01-358-2145	14.10	Composite
			BRACKET <b>WC1-358-3887</b>	
<b>APPLICATIONS:</b> Hendrickson S-28929 Order No. WC1-358-1674				

BELLOWS <b>1T15M6</b>	AON <b>W01-358-1096</b>	C01-358-2149	14.55	Aluminum
			BRACKET <b>WC1-358-3887</b>	
<b>APPLICATIONS:</b> Goodyear 1R12-494 566243142 Order No. WC1-358-0652				

BELLOWS <b>1T15M6</b>	AON <b>W01-358-8591</b>	C01-358-2149	15.92	Composite
			BRACKET <b>WC1-358-3887</b>	
<b>APPLICATIONS:</b> Volvo 3180673 <b>OBSELETE: NO LONGER AVAILABLE</b> Order No. WC1-358-1628				

BELLOWS <b>1T15M6</b>	AON <b>W01-358-8824</b>	C01-358-2149	13.88	Composite
			BRACKET <b>WC1-358-3887</b>	
<b>APPLICATIONS:</b> Tuthill-Reycro 702614-01 Order No. WC1-358-9452 PL				

BELLOWS <b>1T15M6</b>	AON <b>W01-358-8825</b>	C01-358-2149	13.74	Composite
			BRACKET <b>WC1-358-3887</b>	
<b>APPLICATIONS:</b> Watson & Chalin AS-0113 Goodyear 1R12-541 <b>OBSELETE: NO LONGER AVAILABLE</b> Order No. WC1-358-9452				

BELLOWS <b>1T15M6</b>	AON <b>W01-358-8924</b>	C01-358-2149	14.89	Composite
			BRACKET <b>WC1-358-3887</b>	
<b>APPLICATIONS:</b> Ridewell 1003588924C Order No. WC1-358-9452				

**HARDWARE KEY**

- Bolt or Stud 1/2-13
- ⊗ Air Inlet 1/4 N.P.T.
- ⊗ Combination Stud/Air Inlet Stud Outside Thread is 3/4-16 Pistons
- ⊗ Exception to Standard Stud/Air Inlet Stud Inside Thread of 1/4 N.P.T.
- ▲ No Alignment Specified-Center Stud Mounting is Standard
- ⊗ Threaded Hole 3/8-16 Blind Nut on Bead Plates 1/2-13 Pistons

BELLOWS <b>1T15M6</b>	AON <b>W01-358-8927</b>	C01-358-2149	14.54	Composite
<p>CROSS SECTION</p>	<p>BEAD PLATE TOP</p>	<p>PISTON BOTTOM</p>	<p>9544/ NAD-29826</p> <p>ORDER NO. WC1-358-0666</p>	<p><b>APPLICATIONS:</b> Watson &amp; Chalin AS-0062</p> <p><b>OBSOLETE: NO LONGER AVAILABLE</b></p>

BELLOWS <b>1T15M6</b>	AON <b>W01-358-9026</b>	C01-358-2149	12.70	Composite
<p>CROSS SECTION</p>	<p>BEAD PLATE TOP</p>	<p>PISTON BOTTOM</p>	<p>9532/ NAD-29827</p> <p>ORDER NO. WC1-358-1619</p>	<p><b>APPLICATIONS:</b> Peterbilt 03-06213 Peterbilt 03-07111 (Low Air Leaf)</p>

BELLOWS <b>1T15M6</b>	AON <b>W01-358-9082</b>	C01-358-2149	14.59	Composite
<p>CROSS SECTION</p>	<p>BEAD PLATE TOP</p>	<p>PISTON BOTTOM</p>	<p>SERVICE ASSEMBLY <b>W01-358-0712</b></p> <p>ORDER NO. WC1-358-9452</p>	<p><b>APPLICATIONS:</b> Hendrickson Can. S2066, S11651, B-12514-007 Kelderman Hutchens H-9630-01 Kwik Lok/ToDo (Jifflox) CP-5125 Holland (Neway) 90557006, 90557027, 90557033 (special mounting), 90557037, 90557054, 90557075 Reyco 12882-01, R &amp; S Truck &amp; body 1090217 Ridewell 1003589082C, Silent Drive, Watson &amp; Chalin AS-0011</p>

BELLOWS <b>1T15M6</b>	AON <b>W01-358-9083</b>	C01-358-2149	13.22	Composite
<p>CROSS SECTION</p>	<p>BEAD PLATE TOP</p>	<p>PISTON BOTTOM</p>	<p>SERVICE ASSEMBLY <b>W01-358-9080</b></p> <p>ORDER NO. WC1-358-9452</p>	<p><b>APPLICATIONS:</b> Granning 1359 Watson &amp; Chalin AS-0028 Ridewell 1003589083C Hendrickson Trailer S1561</p>

BELLOWS <b>1T15M6</b>	AON <b>W01-358-9092</b>	C01-358-2149	15.11	Composite
<p>CROSS SECTION</p>	<p>BEAD PLATE TOP</p>	<p>PISTON BOTTOM</p>	<p>ORDER NO. WC1-358-9452</p>	<p><b>APPLICATIONS:</b> Holland (Neway) 90557031 Hendrickson Can. S12353</p>

BELLOWS <b>1T15M6</b>	AON <b>W01-358-9093</b>	C01-358-2149	15.98	Composite
<p>CROSS SECTION</p>	<p>BEAD PLATE TOP</p>	<p>PISTON BOTTOM</p>	<p>ORDER NO. WC1-358-9453</p>	<p>SERVICE ASSEMBLY <b>W01-358-0712</b></p> <p><b>APPLICATIONS:</b> Holland (Neway) 90557007 Holland (Neway) 90557032 Holland (Neway) 90557035</p>

BELLOWS <b>1T15M6</b>	AON <b>W01-358-9096</b>	C01-358-2149	14.79	Composite
<p>CROSS SECTION</p>	<p>BEAD PLATE TOP</p>	<p>PISTON BOTTOM</p>	<p>Order No. WC1-358-9452</p>	<p>SERVICE ASSEMBLY <b>W01-358-0707</b></p> <p><b>APPLICATIONS:</b> Fruehauf UCE-1304-1</p>

BELLOWS <b>1T15M6</b>	AON <b>W01-358-9193</b>	C01-358-2149	15.09	Composite
<p>CROSS SECTION</p>	<p>BEAD PLATE TOP</p>	<p>PISTON BOTTOM</p>	<p>ORDER NO. WC1-358-9452</p>	<p><b>APPLICATIONS:</b> Holland (Neway) 90557101 REPLACEMENT PISTON COMES WITHOUT STUDS</p> <p><b>OBSOLETE: NO LONGER AVAILABLE</b></p>

BELLOWS <b>1T15M6</b>	AON <b>W01-358-9194</b>	C01-358-2149	12.99	Composite
<p>CROSS SECTION</p>	<p>BEAD PLATE TOP</p>	<p>PISTON BOTTOM</p>	<p>Order No. WC1-358-1619</p>	<p><b>APPLICATIONS:</b> Peterbilt 03-05107</p>

BELLOWS <b>1T15M6</b>	AON <b>W01-358-9210</b>	C01-358-2149	15.88	Aluminum
<p>CROSS SECTION</p>	<p>BEAD PLATE TOP</p>	<p>PISTON BOTTOM</p>	<p>ORDER NO. WC1-358-0697</p>	<p>SERVICE ASSEMBLY <b>W01-358-9080</b></p> <p><b>APPLICATIONS:</b> Granning 2577</p>

**HARDWARE KEY**

- Bolt or Stud 1/2-13
- ⊗ Air Inlet 1/4 N.P.T.
- ⊗ Combination Stud/Air Inlet Stud Outside Thread is 3/4-16 Pistons
- ⊗ Exception to Standard Stud/Air Inlet Stud Inside Thread of 1/4 N.P.T.
- ▲ No Alignment Specified-Center Stud Mounting is Standard
- ⊗ Threaded Hole 3/8-16 Blind Nut on Bead Plates 1/2-13 Pistons



BELLOWS <b>1T15M6</b>	AON <b>W01-358-9211</b>	C01-358-2149 17.34 Aluminum
CROSS SECTION	BEAD PLATE TOP	PISTON BOTTOM
SERVICE ASSEMBLY <b>W01-358-0712</b>		
<b>APPLICATIONS:</b> Granning 2692		
<b>OBSOLETE: NO LONGER AVAILABLE</b>		

BELLOWS <b>1T15M6</b>	AON <b>W01-358-9213</b>	C01-358-2149 13.29 Composite
CROSS SECTION	BEAD PLATE TOP	PISTON BOTTOM
SERVICE ASSEMBLY <b>W01-358-0748</b>		
<b>APPLICATIONS:</b> Navistar 501559C-1 Navistar 501559C-2 Navistar 1660581C-1		

BELLOWS <b>1T15M6</b>	AON <b>W01-358-9219</b>	C01-358-2149 13.54 Composite
CROSS SECTION	BEAD PLATE TOP	PISTON BOTTOM
<b>APPLICATIONS:</b> Volvo/GM Heavy Duty Truck 35003-3201 Volvo/GM Heavy Duty Truck 35203-3202 Volvo/GM Heavy Duty Truck 35003-3204 Volvo/GM Heavy Duty Truck 35003-3209		

BELLOWS <b>1T15M6</b>	AON <b>W01-358-9223</b>	C01-358-2149 20.57 Composite
CROSS SECTION	BEAD PLATE TOP	PISTON BOTTOM
<b>APPLICATIONS:</b> Reyco 12884-01 Reyco 12884-01A (102AR) Hendrickson 48195-2		
<b>REPLACES 1T15LX8</b>		

BELLOWS <b>1T15M6</b>	AON <b>W01-358-9227</b>	C01-358-2149 14.98 Composite
CROSS SECTION	BEAD PLATE TOP	PISTON BOTTOM
<b>APPLICATIONS:</b> Hendrickson Trailer S2924 Hendrickson 48195-1 (b.plate studs-1.35) (2 studs in piston at 90deg alignment)		

BELLOWS <b>1T15M6</b>	AON <b>W01-358-9296</b>	C01-358-2149 14.39 Composite
CROSS SECTION	BEAD PLATE TOP	PISTON BOTTOM
BRACKET <b>WC1-358-3873</b>		
<b>APPLICATIONS:</b> Volvo/GM 8061151 Volvo/GM 8169868		

BELLOWS <b>1T15M6</b>	AON <b>W01-358-9304</b>	C01-358-2149 16.20 Composite
CROSS SECTION	BEAD PLATE TOP	PISTON BOTTOM
<b>APPLICATIONS:</b> Holland (Neway) 90557124 (AR-90115 & 16) Watson & Chalin AS-0059		

BELLOWS <b>1T15M6</b>	AON <b>W01-358-9362</b>	C01-358-2149 14.88 Composite
CROSS SECTION	BEAD PLATE TOP	PISTON BOTTOM
<b>APPLICATIONS:</b> Watson & Chalin AS-0049 Holland (Neway) 90557113 (AR90-1-14&17) (AR75-6&9)		

BELLOWS <b>1T15M6</b>	AON <b>W01-358-9392</b>	C01-358-2149 16.02 Composite
CROSS SECTION	BEAD PLATE TOP	PISTON BOTTOM
SERVICE ASSEMBLY <b>W01-358-0712</b>		
<b>APPLICATIONS:</b> Hendrickson Trailer S4773		

BELLOWS <b>1T15M6</b>	AON <b>W01-358-9466</b>	C01-358-2149 14.33 Composite
CROSS SECTION	BEAD PLATE TOP	PISTON BOTTOM
<b>APPLICATIONS:</b> Hendrickson 49048 (Ford) Hendrickson 49674-1&2 (Mack) (57QL411M) Hendrickson 49207 (Marmon) HA-360/400/460 [up to 1991]		

**HARDWARE KEY**

- Bolt or Stud 1/2-13
- ⊗ Air Inlet 1/4 N.P.T.
- ⊗ Combination Stud/Air Inlet Stud Outside Thread is 3/4-16 Pistons
- ⊗ Exception to Standard Stud/Air Inlet Stud Inside Thread of 1/4 N.P.T.
- ▲ No Alignment Specified-Center Stud Mounting is Standard
- ⊗ Threaded Hole 3/8-16 Blind Nut on Bead Plates 1/2-13 Pistons

BELLOWS <b>1T15M6</b>	AON <b>W01-358-9474</b>	C01-358-2149	15.12	Aluminum	
<p>CROSS SECTION</p>	<p>BEAD PLATE TOP</p>	<p>PISTON BOTTOM</p>	<p><b>APPLICATIONS:</b> Reyco 20966-01 Everly</p> <p>ORDER NO. WC1-358-0651</p>		

BELLOWS <b>1T15M6</b>	AON <b>W01-358-9496</b>	C01-358-2149	15.19	Composite	
<p>CROSS SECTION</p>	<p>BEAD PLATE TOP</p>	<p>PISTON BOTTOM</p>	<p>BRACKET <b>WC1-358-3887</b></p> <p><b>APPLICATIONS:</b> Holland (Neway) 90557208</p> <p><b>OBSELETE: NO LONGER AVAILABLE</b></p> <p>ORDER NO. WC1-358-1619</p>		

BELLOWS <b>1T15M6</b>	AON <b>W01-358-9966</b>	C01-358-2149	22.36	Aluminum	
<p>CROSS SECTION</p>	<p>BEAD PLATE TOP</p>	<p>PISTON BOTTOM</p>	<p><b>APPLICATIONS:</b> Reyco 20124-02 (1/2 NPT) Reyco 20124-01 Reyco 20124-01K (1/4 NPT) - [Use 1/2 to 1/4 NPT adaptor]</p> <p>Order No. WC1-358-0660</p>		

BELLOWS <b>1T15M7.5</b>	AON <b>W01-358-8888</b>	C01-358-2197	13.99	Composite	
<p>CROSS SECTION</p>	<p>BEAD PLATE TOP</p>	<p>PISTON BOTTOM</p>	<p><b>APPLICATIONS:</b> Rowe Truck 0027 ASC2500</p> <p>ORDER NO. WC1-358-9452</p>		

BELLOWS <b>1T15M7.5</b>	AON <b>W01-358-9342</b>	C01-358-2197	13.65	Composite	
<p>CROSS SECTION</p>	<p>BEAD PLATE TOP</p>	<p>PISTON BOTTOM</p>	<p><b>APPLICATIONS:</b> Granning 2727 (supersedes 9298) Chalmers (remove bolt) - Suspension should have axle stops - if not: use W01-358-9245</p> <p>ORDER NO. WC1-358-9452</p>		

BELLOWS <b>1T15M7.5</b>	AON <b>W01-358-9902</b>	C01-358-2197	14.70	Composite	
<p>CROSS SECTION</p>	<p>BEAD PLATE TOP</p>	<p>PISTON BOTTOM</p>	<p><b>APPLICATIONS:</b> Holland (Neway) 90557138</p> <p>Order No. WC1-358-0666</p>		

BELLOWS <b>1T15M7.5</b>	AON <b>W01-358-9921</b>	C01-358-2197	13.70	Composite	
<p>CROSS SECTION</p>	<p>BEAD PLATE TOP</p>	<p>PISTON BOTTOM</p>	<p><b>APPLICATIONS:</b> Holland (Neway) 90557117 (AR92-12 &amp; 14), (AR93-14) Watson &amp; Chalin AS-0090 Silent Drive</p> <p>ORDER NO. WC1-358-0666</p>		

BELLOWS <b>1T15M7.5</b>	AON <b>W01-358-9922</b>	C01-358-2197	15.04	Composite	
<p>CROSS SECTION</p>	<p>BEAD PLATE TOP</p>	<p>PISTON BOTTOM</p>	<p><b>APPLICATIONS:</b> Holland (Neway) 90557119 (AR92-17) (AR93-17)</p> <p>Order No. WC1-358-0664</p>		

BELLOWS <b>1T15M7.5</b>	AON <b>W01-358-9923</b>	C01-358-2197	13.74	Composite	
<p>CROSS SECTION</p>	<p>BEAD PLATE TOP</p>	<p>PISTON BOTTOM</p>	<p><b>APPLICATIONS:</b> Holland (Neway) 90557118 (AR92 &amp; 93-15&amp;16)</p> <p>ORDER NO. WC1-358-1619</p>		

BELLOWS <b>1T15M7.5</b>	AON <b>W01-358-9935</b>	C01-358-2197	13.81	Composite	
<p>CROSS SECTION</p>	<p>BEAD PLATE TOP</p>	<p>PISTON BOTTOM</p>	<p><b>APPLICATIONS:</b> Holland (Neway) 90557157 (RL-228-17) Holland (Neway) 90557301</p> <p>Order No. WC1-358-1619</p>		

**HARDWARE KEY**

- Bolt or Stud 1/2-13
- ⊗ Air Inlet 1/4 N.P.T.
- ⊗ Combination Stud/Air Inlet Stud Outside Thread is 3/4-16 Pistons
- ⊗ Exception to Standard Stud/Air Inlet Stud Inside Thread of 1/4 N.P.T.
- ▲ No Alignment Specified-Center Stud Mounting is Standard
- ⊗ Threaded Hole 3/8-16 Blind Nut on Bead Plates 1/2-13 Pistons

BELLOWS <b>1T15M7.5</b>	AON <b>W01-358-9936</b>	C01-358-2197	13.91	Composite
			<b>APPLICATIONS:</b> Holland (Neway) 90557156 (RL-228-14, 15, 16) Holland (Neway) 90557300	
CROSS SECTION	BEAD PLATE TOP	PISTON BOTTOM	Order No. WC1-358-0666	

BELLOWS <b>1T15M7.5</b>	AON <b>W01-358-9942</b>	C01-358-2197	14.14	Composite
			<b>APPLICATIONS:</b> Holland (Neway) 90557142	
CROSS SECTION	BEAD PLATE TOP	PISTON BOTTOM	Order No. WC1-358-1619	

BELLOWS <b>1T15M7.5</b>	AON <b>W01-358-9943</b>	C01-358-2197	15.16	Composite
			<b>APPLICATIONS:</b> Holland (Neway) 90557143	
CROSS SECTION	BEAD PLATE TOP	PISTON BOTTOM	<b>OBSELETE: NO LONGER AVAILABLE</b>	

BELLOWS <b>1T15M7.5</b>	AON <b>W01-358-9947</b>	C01-358-2197	15.88	Composite
			<b>APPLICATIONS:</b> Reyco 20142-01 & 01K	
CROSS SECTION	BEAD PLATE TOP	PISTON BOTTOM	Order No. WC1-358-0666	

BELLOWS <b>1T15M7.5</b>	AON <b>W01-358-9971</b>	C01-358-2197	84.68	Aluminum
			<b>APPLICATIONS:</b> Holland (Neway) 90557295 (RL230, GRL228)	
CROSS SECTION	BEAD PLATE TOP	PISTON BOTTOM	ORDER NO. WC1-358-0659	

BELLOWS <b>1T15M7.5</b>	AON <b>W01-358-9974</b>	C01-358-2197	14.34	Aluminum
			<b>APPLICATIONS:</b> Holland 90557332	
CROSS SECTION	BEAD PLATE TOP	PISTON BOTTOM	ORDER NO. WC1-358-0659	

BELLOWS <b>1T15M8</b>	AON <b>W01-358-9287</b>	C01-358-2160	18.50	Composite
			<b>APPLICATIONS:</b> Hendrickson 50405-1&2 (Ford, W.Star) HA-360/400/460 [1991-Up] Hendrickson 50405 (remove intermediate plate and use new production version with bracket)	
CROSS SECTION	BEAD PLATE TOP	PISTON BOTTOM	BRACKET <b>WC1-358-3903</b> Order No. WC1-358-1606	

BELLOWS <b>1T15M8</b>	AON <b>W01-358-9297</b>	C01-358-2160	16.48	Composite
			<b>APPLICATIONS:</b> Hendrickson 50898-1 & 2 (GH & Ford) (class 6, 7 & 8) Hendrickson Truck 64651-2	
CROSS SECTION	BEAD PLATE TOP	PISTON BOTTOM	BRACKET <b>WC1-358-3903</b> Order No. WC1-358-1628	

BELLOWS <b>1T15M8</b>	AON <b>W01-358-9371</b>	C01-358-2160	17.96	Composite
			<b>APPLICATIONS:</b> Navistar 1670073C-1 Navistar 1686386C-1	
CROSS SECTION	BEAD PLATE TOP	PISTON BOTTOM	BRACKET <b>WC1-358-3888</b> ORDER NO. WC1-358-1620	

BELLOWS <b>1T15M8</b>	AON <b>W01-358-9373</b>	C01-358-2160	16.05	Composite
			<b>APPLICATIONS:</b> Hendrickson 57122-2 (Ford, class 8) HAS-360/400/402/460	
CROSS SECTION	BEAD PLATE TOP	PISTON BOTTOM	BRACKET <b>WC1-358-3903</b> Order No. WC1-358-1628	

**HARDWARE KEY**  
 ● Bolt or Stud 1/2-13      ⊗ Air Inlet 1/4 N.P.T.  
 ⊗ Combination Stud/Air Inlet Stud Outside Thread is 3/4-16 Pistons  
 ⊗ Exception to Standard Stud/Air Inlet Stud Inside Thread of 1/4 N.P.T.  
 ▲ No Alignment Specified-Center Stud Mounting is Standard  
 ⊕ Threaded Hole 3/8-16 Blind Nut on Bead Plates 1/2-13 Pistons

BELLOWS <b>1T15M8</b>	AON <b>W01-358-9375</b>	C01-358-2160 16.88 Composite
CROSS SECTION	BEAD PLATE TOP	PISTON BOTTOM
BRACKET <b>WC1-358-3904</b>		
<b>APPLICATIONS:</b> Hendrickson 50899 -1 & 2 (Mack-class 8) 57QL414M Mack 3645Q27		

BELLOWS <b>1T15M8</b>	AON <b>W01-358-9641</b>	C01-358-2160 16.75 Composite
CROSS SECTION	BEAD PLATE TOP	PISTON BOTTOM
BRACKET <b>WC1-358-3906</b>		
<b>APPLICATIONS:</b> Hendrickson 59010-2		

BELLOWS <b>1T15M8</b>	AON <b>W01-358-9647</b>	C01-358-2160 15.86 Composite
CROSS SECTION	BEAD PLATE TOP	PISTON BOTTOM
BRACKET <b>WC1-358-3906</b>		
<b>APPLICATIONS:</b> Hendrickson 58786-2 (MACK 57QL417M)		
<b>REPLACES 1T15MT8</b>		

BELLOWS <b>1T15M8</b>	AON <b>W01-358-9649</b>	C01-358-2160 17.22 Composite
CROSS SECTION	BEAD PLATE TOP	PISTON BOTTOM
BRACKET <b>WC1-358-1606</b>		
<b>APPLICATIONS:</b> Holland (Neway) 90557252		

BELLOWS <b>1T15M8</b>	AON <b>W01-358-9654</b>	C01-358-2160 15.10 Composite
CROSS SECTION	BEAD PLATE TOP	PISTON BOTTOM
BRACKET <b>WC1-358-3715</b>		
<b>APPLICATIONS:</b> Hendrickson 65032-2 Mack 57QL53M		

BELLOWS <b>1T15M8</b>	AON <b>W01-358-9663</b>	C01-358-2160 16.23 Composite
CROSS SECTION	BEAD PLATE TOP	PISTON BOTTOM
BRACKET <b>WC1-358-3906</b>		
<b>APPLICATIONS:</b> Hendrickson Truck 60271-2 Mack 57WL57M		

BELLOWS <b>1T15M8</b>	AON <b>W01-M58-9372</b>	C01-M58-2123 16.74 Composite
CROSS SECTION	BEAD PLATE TOP	PISTON BOTTOM
BRACKET <b>WC1-358-1628</b>		
<b>APPLICATIONS:</b> Hendrickson 58520-2 (Nissan) (replaces 58654-2) Hendrickson Truck 64489-2		

BELLOWS <b>1T15M8</b>	AON <b>W01-M58-9656</b>	C01-M58-2123 19.00 Composite
CROSS SECTION	BEAD PLATE TOP	PISTON BOTTOM
BRACKET <b>WC1-358-1628</b>		
<b>APPLICATIONS:</b> Hendrickson Truck 64651-2 Mack 57QL57M		

BELLOWS <b>1T15M9</b>	AON <b>W01-358-0783</b>	C01-358-1000 27.50 Composite
CROSS SECTION	BEAD PLATE TOP	PISTON BOTTOM
BRACKET <b>WC1-358-1000</b>		
<b>APPLICATIONS:</b> Goodyear 1R12-467 Ridewell 1000001		

BELLOWS <b>1T15M9</b>	AON <b>W01-358-8842</b>	C01-358-1000 15.21 Composite
CROSS SECTION	BEAD PLATE TOP	PISTON BOTTOM
BRACKET <b>WC1-358-1619</b>		
<b>APPLICATIONS:</b> Link 1103-0058		

**HARDWARE KEY**

- Bolt or Stud 1/2-13
- ⊗ Air Inlet 1/4 N.P.T.
- ⊗ Combination Stud/Air Inlet Stud Outside Thread is 3/4-16 Pistons
- ⊗ Exception to Standard Stud/Air Inlet Stud Inside Thread of 1/4 N.P.T.
- ▲ No Alignment Specified-Center Stud Mounting is Standard
- ⊗ Threaded Hole 3/8-16 Blind Nut on Bead Plates 1/2-13 Pistons

BELLOWS <b>1T15M9</b>		AON <b>W01-358-8852</b>		C01-358-1000 13.19 Composite	
	3302 	9532/NAD-29827 	<b>APPLICATIONS:</b> Peterbilt 03-07887 (Low Air Leaf)		
CROSS SECTION	BEAD PLATE TOP	PISTON BOTTOM	ORDER NO. WC1-358-1619		

BELLOWS <b>1T15M9</b>		AON <b>W01-358-8855</b>		C01-358-1000 14.64 Composite	
	3242 	9530/ NAD-27809 	<b>APPLICATIONS:</b> Reyco 23521-01		
CROSS SECTION	BEAD PLATE TOP	PISTON BOTTOM	ORDER NO. WC1-358-9452		

BELLOWS <b>1T15M9</b>		AON <b>W01-358-8856</b>		C01-358-1000 14.53 Composite	
	3242 	9532/NAD-29827 	<b>APPLICATIONS:</b> Reyco 23521-02		
CROSS SECTION	BEAD PLATE TOP	PISTON BOTTOM	Order No. WC1-358-1619		

BELLOWS <b>1T15M9</b>		AON <b>W01-358-8861</b>		C01-358-1000 15.46 Composite	
	3192 	9530/NAD-27809 	<b>APPLICATIONS:</b> Watson & Chalin AS-0061-1 Goodyear 1R12-534		
CROSS SECTION	BEAD PLATE TOP	PISTON BOTTOM	Order No. WC1-358-9452		

BELLOWS <b>1T15M9</b>		AON <b>W01-358-8864</b>		C01-358-1000 14.06 Composite	
	3202 	9531 / NAD-28197 	<b>APPLICATIONS:</b> Peterbilt 03-08716 (New Low Leaf Supersedes 03-07887 effective 04/04) CB11011 Paccar Part		
CROSS SECTION	BEAD PLATE TOP	PISTON BOTTOM	ORDER NO. WC1-358-1626		

**HARDWARE KEY**

- Bolt or Stud 1/2-13
- ⊗ Air Inlet 1/4 N.P.T.
- ⊗ Combination Stud/Air Inlet Stud Outside Thread is 3/4-16 Pistons
- ⊗ Exception to Standard Stud/Air Inlet Stud Inside Thread of 1/4 N.P.T.
- ▲ No Alignment Specified-Center Stud Mounting is Standard
- ⊗ Threaded Hole 3/8-16 Blind Nut on Bead Plates 1/2-13 Pistons

BELLOWS <b>1T15M9</b>		AON <b>W01-358-9101</b>		C01-358-1000 16.65 Composite	
	3235 	9553 / NAD-29467 	<b>APPLICATIONS:</b> Holland (Neway) 90557008, 90557009, 90557082 Ridewell 1003589101C Reyco 12883-01 Silent Drive Truckstell (Marion Mfg.) 63647 MFG.SV.# Neway 90044201 Watson & Chalin AS-0040		
CROSS SECTION	BEAD PLATE TOP	PISTON BOTTOM	ORDER NO. WC1-358-9453		

BELLOWS <b>1T15M9</b>		AON <b>W01-358-9106</b>		C01-358-1000 17.98 Aluminum	
	3201 	9653/NBD-10437 OR 6777/FIP-103970 	<b>APPLICATIONS:</b>		
CROSS SECTION	BEAD PLATE TOP	PISTON BOTTOM	Order No. WC1-358-0620		

BELLOWS <b>1T15M9</b>		AON <b>W01-358-9130</b>		C01-358-1000 16.31 Composite	
	3271 	9553/NAD-29467 	<b>APPLICATIONS:</b>		
CROSS SECTION	BEAD PLATE TOP	PISTON BOTTOM	Order No. WC1-358-9453		

BELLOWS <b>1T15M9</b>		AON <b>W01-358-9192</b>		C01-358-1000 15.87 Composite	
	3235 	9530/NAD-27809 	<b>APPLICATIONS:</b> Hendrickson Trailer S6195 Holland (Neway) 90557086 90557108 (AR-90) Watson & Chalin AS-0038 AS-0046 Rotate Piston 90557135-28LH Rotate Piston 90557136-28RH		
CROSS SECTION	BEAD PLATE TOP	PISTON BOTTOM	Order No. WC1-358-9452		

BELLOWS <b>1T15M9</b>		AON <b>W01-358-9203</b>		C01-358-1000 15.98 Composite	
	3271 	9530/NAD-27809 	<b>APPLICATIONS:</b> Hendrickson Trailer S2694		
CROSS SECTION	BEAD PLATE TOP	PISTON BOTTOM	Order No. WC1-358-9452		

BELLOWS <b>1T15M9</b>	AON <b>W01-358-9238</b>	C01-358-1000	16.38	Composite
<p>CROSS SECTION</p>	<p>BEAD PLATE TOP</p>	<p>PISTON BOTTOM</p>	<p><b>APPLICATIONS:</b> Hendrickson Trailer S5060</p>	
	3210	9553/NAD-29467	<p>Order No. WC1-358-9453</p>	

BELLOWS <b>1T15M9</b>	AON <b>W01-358-9240</b>	C01-358-1000	16.63	Composite
<p>CROSS SECTION</p>	<p>BEAD PLATE TOP</p>	<p>PISTON BOTTOM</p>	<p><b>APPLICATIONS:</b> Hendrickson Trailer S3842 Hendrickson Can. S10352</p>	
	3235	9553 / NAD-29467	<p>ORDER NO. WC1-358-9453</p>	
<b>OBSELETE: NO LONGER AVAILABLE</b>				

BELLOWS <b>1T15M9</b>	AON <b>W01-358-9241</b>	C01-358-1000	16.17	Composite
<p>CROSS SECTION</p>	<p>BEAD PLATE TOP</p>	<p>PISTON BOTTOM</p>	<p><b>APPLICATIONS:</b></p>	
	3271	9553/NAD-29467	<p>Order No. WC1-358-9453</p>	

BELLOWS <b>1T15M9</b>	AON <b>W01-358-9243</b>	C01-358-1000	14.44	Composite
<p>CROSS SECTION</p>	<p>BEAD PLATE TOP</p>	<p>PISTON BOTTOM</p>	<p><b>APPLICATIONS:</b> Holland (Neway) 900557112 (AR90-[All]) (ARU92-9&amp;10) Watson &amp; Chalin AS-0061</p>	
	3235	9532 / NAD-29827	<p>ORDER NO. WC1-358-1619</p>	

BELLOWS <b>1T15M9</b>	AON <b>W01-358-9245</b>	C01-358-1000	15.80	Composite
<p>CROSS SECTION</p>	<p>BEAD PLATE TOP</p>	<p>PISTON BOTTOM</p>	<p>SERVICE ASSEMBLY <b>W01-358-9102</b></p> <p><b>APPLICATIONS:</b> Ridewell 1003589245C</p>	
	3490	9530 / NAD-27809	<p>Order No. WC1-358-9452</p>	

BELLOWS <b>1T15M9</b>	AON <b>W01-358-9346</b>	C01-358-1000	16.60	Composite
<p>CROSS SECTION</p>	<p>BEAD PLATE TOP</p>	<p>PISTON BOTTOM</p>	<p>SERVICE ASSEMBLY <b>W01-358-9102</b></p> <p><b>APPLICATIONS:</b> Holland (Neway) 90557126 (AR-75-12) (AR-75-1-12) (ARU92-12) Watson &amp; Chalin AS-0056</p>	
	3235	9540/NAD-29828	<p>Order No. WC1-358-0664</p>	

BELLOWS <b>1T15M9</b>	AON <b>W01-358-9348</b>	C01-358-1000	16.87	Composite
<p>CROSS SECTION</p>	<p>BEAD PLATE TOP</p>	<p>PISTON BOTTOM</p>	<p><b>APPLICATIONS:</b> CCG McCullough Trailer</p>	
	3173	9553/NAD-29467	<p>Order No. WC1-358-9453</p>	
<b>OBSELETE: NO LONGER AVAILABLE</b>				

BELLOWS <b>1T15M9</b>	AON <b>W01-358-9350</b>	C01-358-1000	14.60	Composite
<p>CROSS SECTION</p>	<p>BEAD PLATE TOP</p>	<p>PISTON BOTTOM</p>	<p><b>APPLICATIONS:</b> Watson &amp; Chalin</p>	
	3271	9553/NAD-29467	<p>Order No. WC1-358-9453</p>	

BELLOWS <b>1T15M9</b>	AON <b>W01-358-9394</b>	C01-358-1000	16.50	Composite
<p>CROSS SECTION</p>	<p>BEAD PLATE TOP</p>	<p>PISTON BOTTOM</p>	<p><b>APPLICATIONS:</b> Fruehauf UCD-9393-2 (if bolt is removed, this part can replace the UCE-9393-1) Suspensions Inc. 200041 Supersedes 9241</p>	
	3271	9553/NAD-29467	<p>Order No. WC1-358-9453</p>	

BELLOWS <b>1T15M11</b>	AON <b>W01-358-9320</b>	C01-358-5129	17.33	Composite
<p>CROSS SECTION</p>	<p>BEAD PLATE TOP</p>	<p>PISTON BOTTOM</p>	<p><b>APPLICATIONS:</b> Holland (Neway) 90557099 Silent Drive</p>	
	3490	9553/NAD-29467	<p>Order No. WC1-358-9453</p>	

**HARDWARE KEY**

- Bolt or Stud 1/2-13
- ⊗ Air Inlet 1/4 N.P.T.
- ⊙ Combination Stud/Air Inlet Stud Outside Thread is 3/4-16 Pistons
- ⊕ Exception to Standard Stud/Air Inlet Stud Inside Thread of 1/4 N.P.T.
- ▲ No Alignment Specified-Center Stud Mounting is Standard
- ⊖ Threaded Hole 3/8-16 Blind Nut on Bead Plates 1/2-13 Pistons

BELLOWS <b>1T15M11</b>	AON <b>W01-358-9321</b>	C01-358-5129	19.76	Aluminum	
<p>CROSS SECTION</p>	<p>BEAD PLATE TOP</p>	<p>PISTON BOTTOM</p>	<p><b>APPLICATIONS:</b> Watson &amp; Chain AS-0036</p>		
	3271	9653/NBD-10437	Order No. WC1-358-0620		

BELLOWS <b>1T15M11</b>	AON <b>W01-358-9367</b>	C01-358-5129	20.41	Aluminum	
<p>CROSS SECTION</p>	<p>BEAD PLATE TOP</p>	<p>PISTON BOTTOM</p>	<p><b>APPLICATIONS:</b> Hendrickson S14249 (W01-455-9321) Hendrickson Aux. 003319 (metric equivalent)</p>		
	3188	9653/NBD-10437	Order No. WC1-358-0620		

BELLOWS <b>1T15M11</b>	AON <b>W01-358-9368</b>	C01-358-5129	20.71	Composite	
<p>CROSS SECTION</p>	<p>BEAD PLATE TOP</p>	<p>PISTON BOTTOM</p>	<p><b>APPLICATIONS:</b> Ridewell 1003589368C</p> <p><b>OBSELETE: NO LONGER AVAILABLE</b></p>		
	3205	9553/NAD-29467	Order No. WC1-358-9453		

BELLOWS <b>1T15M11</b>	AON <b>W01-358-9370</b>	C01-358-5129	16.96	Composite	
<p>CROSS SECTION</p>	<p>BEAD PLATE TOP</p>	<p>PISTON BOTTOM</p>	<p><b>APPLICATIONS:</b> Watson &amp; Chain AS-0057</p>		
	3188	9540/NAD-29828	Order No. WC1-358-0664		

BELLOWS <b>1T15MA4</b>	AON <b>W01-M58-9851</b>	C01-M58-2292	13.00	Composite	
<p>CROSS SECTION</p>	<p>BEAD PLATE TOP</p>	<p>PISTON BOTTOM</p>	<p><b>APPLICATIONS:</b> Hendrickson 65086-2</p>		
	3313	9573/NAD-18162	Order No. WC1-358-1634		

**HARDWARE KEY**

- Bolt or Stud 1/2-13
- ⊗ Air Inlet 1/4 N.P.T.
- ⊗ Combination Stud/Air Inlet Stud Outside Thread is 3/4-16 Pistons
- ⊗ Exception to Standard Stud/Air Inlet Stud Inside Thread of 1/4 N.P.T.
- ▲ No Alignment Specified-Center Stud Mounting is Standard
- ⊗ Threaded Hole 3/8-16 Blind Nut on Bead Plates 1/2-13 Pistons

BELLOWS <b>1T15MBTW6</b>	AON <b>W01-358-9644</b>	C01-358-1081	13.84	Composite	
<p>CROSS SECTION</p>	<p>BEAD PLATE TOP</p>	<p>PISTON BOTTOM</p>	<p><b>APPLICATIONS:</b> Hendrickson Trailer S23721</p>		
	3306	9532/NAD-29827	Order No. WC1-358-1619		

BELLOWS <b>1T15MBTW10</b>	AON <b>W01-358-9646</b>	C01-358-1078	14.43	Composite	
<p>CROSS SECTION</p>	<p>BEAD PLATE TOP</p>	<p>PISTON BOTTOM</p>	<p><b>APPLICATIONS:</b> Hendrickson Trailer S23611</p>		
	3306	9532/NAD-29827	Order No. WC1-358-1619		

BELLOWS <b>1T15MBTW12</b>	AON <b>W01-358-9645</b>	C01-358-1079	16.93	Composite	
<p>CROSS SECTION</p>	<p>BEAD PLATE TOP</p>	<p>PISTON BOTTOM</p>	<p><b>APPLICATIONS:</b> Hendrickson Trailer S23612</p>		
	3306	9540/NAD-29828	Order No. WC1-358-0664		

BELLOWS <b>1T15MLW7</b>	AON <b>W01-358-8944</b>	C01-358-0007	16.70	Aluminum	
<p>CROSS SECTION</p>	<p>BEAD PLATE TOP</p>	<p>PISTON BOTTOM</p>	<p><b>APPLICATIONS:</b> Hendrickson Trailer S20217 (HT-190U)</p> <p><b>REPLACES W01-358-9015</b></p>		
	3242	9694/NAD-25396	Order No. WC1-358-1694		

BELLOWS <b>1T15MM9</b>	AON <b>W01-358-9265</b>	C01-358-2203	16.68	Aluminum	
<p>CROSS SECTION</p>	<p>BEAD PLATE TOP</p>	<p>PISTON BOTTOM</p>	<p><b>APPLICATIONS:</b> Hendrickson Trailer S20124 Hendrickson Trailer HT-250T Hendrickson Trailer C20413 (rotate piston to 45deg alignment) Hendrickson Trailer HT-250U (all others) Hendrickson Trailer HT-250U-Y (9Y-001)</p> <p><b>REPLACES 1T15MW10</b></p>		
	3242	9694/NAD-25396	Order No. WC1-358-1694		

BELLOWS <b>1T15MMW8.0</b>	AON <b>W01-M58-7074</b>	C01-M58-0032	13.12	Composite
<p>CROSS SECTION</p>	<p>BEAD PLATE TOP</p>	<p>PISTON BOTTOM</p>	<p><b>APPLICATIONS:</b></p>	

BELLOWS <b>1T15MN6</b>	AON <b>W01-358-8828</b>	C01-358-2200	15.37	Aluminum
<p>CROSS SECTION</p>	<p>BEAD PLATE TOP</p>	<p>PISTON BOTTOM</p>	<p><b>APPLICATIONS:</b></p>	

BELLOWS <b>1T15MPW6</b>	AON <b>W01-358-8494</b>	C01-358-0082	14.07	Composite
<p>CROSS SECTION</p>	<p>BEAD PLATE TOP</p>	<p>PISTON BOTTOM</p>	<p><b>APPLICATIONS:</b></p>	

BELLOWS <b>1T15MPW7</b>	AON <b>W01-358-6231</b>	C01-358-0054	14.54	Composite
<p>CROSS SECTION</p>	<p>BEAD PLATE TOP</p>	<p>PISTON BOTTOM</p>	<p><b>APPLICATIONS:</b> Arvin Meritor 21227742FS FS230</p> <p><b>REPLACES W01-358-6262</b></p>	

BELLOWS <b>1T15MPW7</b>	AON <b>W01-358-6262</b>	C01-358-0054	14.34	Composite
<p>CROSS SECTION</p>	<p>BEAD PLATE TOP</p>	<p>PISTON BOTTOM</p>	<p><b>APPLICATIONS:</b></p>	

**HARDWARE KEY**

- Bolt or Stud 1/2-13
- ⊗ Air Inlet 1/4 N.P.T.
- ⊗ Combination Stud/Air Inlet Stud Outside Thread is 3/4-16 Pistons
- ⊗ Exception to Standard Stud/Air Inlet Stud Inside Thread of 1/4 N.P.T.
- ▲ No Alignment Specified-Center Stud Mounting is Standard
- ⊗ Threaded Hole 3/8-16 Blind Nut on Bead Plates 1/2-13 Pistons

BELLOWS <b>1T15MPW7</b>	AON <b>W01-358-8903</b>	C01-M58-0032	13.64	Composite
<p>CROSS SECTION</p>	<p>BEAD PLATE TOP</p>	<p>PISTON BOTTOM</p>	<p><b>APPLICATIONS:</b> Holland (Neway) 90557169 (Advance Mixer)</p>	

BELLOWS <b>1T15MR2</b>	AON <b>W01-358-9268</b>	C01-358-1016	9.07	No Piston
<p>CROSS SECTION</p>	<p>BEAD PLATE TOP</p>	<p>PISTON BOTTOM</p>	<p><b>APPLICATIONS:</b> Holland (Neway) 90557123 - Service assembly only (no piston) ARD120 &amp; 240-5 (Air Beam) (90054540 w/o bracket)</p>	

BELLOWS <b>1T15MT3</b>	AON <b>W01-358-8466</b>	C01-358-1069	16.37	Composite
<p>CROSS SECTION</p>	<p>BEAD PLATE TOP</p>	<p>PISTON BOTTOM</p>	<p><b>APPLICATIONS:</b></p>	

BELLOWS <b>1T15MT3</b>	AON <b>W01-358-9634</b>	C01-358-1069	16.19	Composite
<p>CROSS SECTION</p>	<p>BEAD PLATE TOP</p>	<p>PISTON BOTTOM</p>	<p><b>APPLICATIONS:</b> Freightliner 16-14263-000 Freightliner 16-15443-000 (6033 bracket) Freightliner 16-14263-001 Freightliner 16-15443-001 (6034 bracket) Freightliner 16-15444-000 service (no bracket, no piston) - reuse old bracket or purchase separately replacement Freightliner 16-19470-000, 16-18333-000, 16-18333-001</p> <p><b>REPLACES 1T15ZR3</b></p>	

BELLOWS <b>1T15MT3</b>	AON <b>W01-358-9640</b>	C01-358-1069	14.27	Aluminum
<p>CROSS SECTION</p>	<p>BEAD PLATE TOP</p>	<p>PISTON BOTTOM</p>	<p><b>APPLICATIONS:</b> Hendrickson Trailer S20223 (HT-190T, HS-190T)</p> <p><b>REPLACES W01-358-9630</b></p>	



BELLOWS <b>1T15MT6</b>	AON <b>W01-358-8831</b>	C01-358-2169	14.69	Composite
			<b>APPLICATIONS:</b>	
CROSS SECTION	BEAD PLATE TOP	PISTON BOTTOM	ORDER NO. WC1-358-1606	

BELLOWS <b>1T15MT6</b>	AON <b>W01-358-9643</b>	C01-358-2169	15.93	Composite
			<b>APPLICATIONS:</b> Hendrickson 58995-2 (Freightliner)	
CROSS SECTION	BEAD PLATE TOP	PISTON BOTTOM	BRACKET <b>WC1-358-3903</b>	
<b>OBSOLETE: NO LONGER AVAILABLE</b>				

BELLOWS <b>1T15MW6</b>	AON <b>W01-358-9299</b>	C01-358-2205	16.41	Aluminum
			<b>APPLICATIONS:</b> Hendrickson Trailer S20716 (HT250U(6.5-002))	
CROSS SECTION	BEAD PLATE TOP	PISTON BOTTOM	Order No. WC1-358-1694	

BELLOWS <b>1T15SN6</b>	AON <b>W01-358-9260</b>	C01-358-2161	13.20	Composite
			<b>APPLICATIONS:</b> Jet Co. (10.3 max.OD) Bolt removed for center mounting	
CROSS SECTION	BEAD PLATE TOP	PISTON BOTTOM	Order No. N/A	

BELLOWS <b>1T15SN6</b>	AON <b>W01-358-9278</b>	C01-358-2161	11.43	Composite
			<b>APPLICATIONS:</b> Caterpillar 102-9283	
CROSS SECTION	BEAD PLATE TOP	PISTON BOTTOM	<b>OBSOLETE: NO LONGER AVAILABLE</b>	

**HARDWARE KEY**

- Bolt or Stud 1/2-13
- ⊗ Air Inlet 1/4 N.P.T.
- ⊗ Combination Stud/Air Inlet Stud Outside Thread is 3/4-16 Pistons
- ⊗ Exception to Standard Stud/Air Inlet Stud Inside Thread of 1/4 N.P.T.
- ▲ No Alignment Specified-Center Stud Mounting is Standard
- ⊗ Threaded Hole 3/8-16 Blind Nut on Bead Plates 1/2-13 Pistons

BELLOWS <b>1T15T1</b>	AON <b>W01-358-9401</b>	C01-358-1013	9.70	Composite
			<b>APPLICATIONS:</b>	
CROSS SECTION	BEAD PLATE TOP	PISTON BOTTOM		

BELLOWS <b>1T15T1</b>	AON <b>W01-358-9402</b>	C01-358-1013	10.64	Composite
			<b>APPLICATIONS:</b> Capacity of Texas	
CROSS SECTION	BEAD PLATE TOP	PISTON BOTTOM	Order No. WC1-358-1642	

BELLOWS <b>1T15T1</b>	AON <b>W01-358-9650</b>	C01-358-1013	12.26	Aluminum
			<b>APPLICATIONS:</b> Holland (Neway) 90557097	
CROSS SECTION	BEAD PLATE TOP	PISTON BOTTOM	Order No. WC1-358-0663	

BELLOWS <b>1T15T1</b>	AON <b>W01-358-9651</b>	C01-358-1013	9.83	Composite
			<b>APPLICATIONS:</b> Monaco Coach 01806160	
CROSS SECTION	BEAD PLATE TOP	PISTON BOTTOM	Order No. WC1-358-0646	

BELLOWS <b>1T15TM1</b>	AON <b>W01-358-5766</b>	C01-358-1008	12.17	Composite
			<b>APPLICATIONS:</b> American Carrier 8003-023 Hutchens 19141-01	
CROSS SECTION	BEAD PLATE TOP	PISTON BOTTOM	Order No. WC1-358-1642	

BELLOWS <b>1T15TM1</b>	AON <b>W01-358-9421</b>	C01-358-1008 10.07 Composite
	3235 	9492/FIP-100742 
CROSS SECTION	BEAD PLATE TOP	PISTON BOTTOM
<p><b>APPLICATIONS:</b> American Carrier 8003-003</p> <p>Order No. WC1-358-1642</p>		

BELLOWS <b>1T15TM1</b>	AON <b>W01-358-9423</b>	C01-358-1008 13.04 Aluminum
	3235 	9655/NBD-10439 
CROSS SECTION	BEAD PLATE TOP	PISTON BOTTOM
<p><b>APPLICATIONS:</b> Ridewell 1003589423C</p> <p>Order No. WC1-358-9454</p> <p><b>OBSELETE: NO LONGER AVAILABLE</b></p>		

BELLOWS <b>1T15TQ1</b>	AON <b>W01-358-5770</b>	C01-358-1030 11.17 Aluminum
	3235 	9681/NBD-14213 
CROSS SECTION	BEAD PLATE TOP	PISTON BOTTOM
<p><b>APPLICATIONS:</b> Ridewell 1003585770C Watson &amp; Chalin AS-0042</p> <p>Order No. WC1-358-1612</p>		

BELLOWS <b>1T15TQ1</b>	AON <b>W01-358-5772</b>	C01-358-1031 9.42 Aluminum
	3235 	9681/NBD-14213 
CROSS SECTION	BEAD PLATE TOP	PISTON BOTTOM
<p><b>APPLICATIONS:</b> Brock Link (see 5789)</p> <p>Order No. WC1-358-1612</p>		

BELLOWS <b>1T15TQ1</b>	AON <b>W01-358-5775</b>	C01-358-1031 11.94 Aluminum
	3211 	9681/NBD-14213 
CROSS SECTION	BEAD PLATE TOP	PISTON BOTTOM
<p><b>APPLICATIONS:</b> Reyco 20783-01</p> <p>Order No. WC1-358-1612</p>		

BELLOWS <b>1T15TQ1</b>	AON <b>W01-358-5776</b>	C01-358-1048 11.64 Aluminum
	3253 	9681/NBD-14213 
CROSS SECTION	BEAD PLATE TOP	PISTON BOTTOM
<p><b>APPLICATIONS:</b> Holland (Neway) 90557174 (AS 120) ref. W01-358-9586 (1/2 NPT)</p> <p>Order No. WC1-358-1612</p>		

BELLOWS <b>1T15TQ1</b>	AON <b>W01-358-5777</b>	C01-358-1031 11.01 Aluminum
	3211 	9681/NBD-14213 
CROSS SECTION	BEAD PLATE TOP	PISTON BOTTOM
<p><b>APPLICATIONS:</b> Reyco 22425-01</p> <p>Order No. WC1-358-1612</p>		

BELLOWS <b>1T15TQ1</b>	AON <b>W01-358-5783</b>	C01-358-1030 10.52 Aluminum
	3235 	4078/NBD-17119 
CROSS SECTION	BEAD PLATE TOP	PISTON BOTTOM
<p><b>APPLICATIONS:</b></p>		

BELLOWS <b>1T15TQ1</b>	AON <b>W01-358-5789</b>	C01-358-1031 11.17 Aluminum
	3235 	9681/NBD-14213 
CROSS SECTION	BEAD PLATE TOP	PISTON BOTTOM
<p><b>APPLICATIONS:</b> Link 1103-0503 Ultraride</p> <p>Order No. WC1-358-1612</p>		

BELLOWS <b>1T15TQ1</b>	AON <b>W01-358-5792</b>	C01-358-1030 11.61 Composite
	3235 	9492/FIP-100742 
CROSS SECTION	BEAD PLATE TOP	PISTON BOTTOM
<p><b>APPLICATIONS:</b> Ridewell 1003585792C</p> <p>Order No. WC1-358-1642</p>		

**HARDWARE KEY**

- Bolt or Stud 1/2-13
- ⊗ Air Inlet 1/4 N.P.T.
- ⊙ Combination Stud/Air Inlet Stud Outside Thread is 3/4-16 Pistons
- ⊙ Exception to Standard Stud/Air Inlet Stud Inside Thread of 1/4 N.P.T.
- ▲ No Alignment Specified-Center Stud Mounting is Standard
- ⊙ Threaded Hole 3/8-16 Blind Nut on Bead Plates 1/2-13 Pistons

PRIMARY TRUCK & TRAILER AXLE

BELLOWS <b>1T15TQ1</b>	AON <b>W01-358-9586</b>	C01-358-1048	11.78	Aluminum
<p>CROSS SECTION BEAD PLATE TOP PISTON BOTTOM</p>	<p>9681/NBD-14213</p> <p>Order No. WC1-358-1612</p>	<p>BRACKET <b>WC1-358-3887</b></p> <p><b>APPLICATIONS:</b> Holland (Neway) 90557249 Replaces 90557221 (1/2 NPT-flush) (ref.W01-358-5776)</p>		

BELLOWS <b>1T15V1</b>	AON <b>W01-358-9249</b>	C01-358-5103	12.16	Composite
<p>CROSS SECTION BEAD PLATE TOP PISTON BOTTOM</p>	<p>3235 9528/NBD-14404</p> <p>Order No. WC1-358-0667</p>	<p><b>APPLICATIONS:</b> Holland (Neway) 90557107 Mercedes Bus Mexico Front</p>		

BELLOWS <b>1T15V3</b>	AON <b>W01-358-9578</b>	C01-358-5098	11.57	Composite
<p>CROSS SECTION BEAD PLATE TOP PISTON BOTTOM</p>	<p>3235 9528/NBD-14404</p> <p>ORDER NO. WC1-358-0667</p>	<p><b>APPLICATIONS:</b> Holland (Neway) 90557232</p>		

BELLOWS <b>1T15V3</b>	AON <b>W01-358-9582</b>	C01-358-5098	13.03	Composite
<p>CROSS SECTION BEAD PLATE TOP PISTON BOTTOM</p>	<p>3235 9528/NBD-14404</p> <p>ORDER NO. WC1-358-0667</p>	<p>SPACER <b>WC1-358-3701</b></p> <p><b>APPLICATIONS:</b> Holland (Neway) 90557240 REPLACEMENT PISTON DOES NOT INCLUDE SPACER</p> <p><b>OBSOLETE: NO LONGER AVAILABLE</b></p>		

BELLOWS <b>1T15V8</b>	AON <b>W01-358-9274</b>	C01-358-5105	19.03	Composite
<p>CROSS SECTION BEAD PLATE TOP PISTON BOTTOM</p>	<p>3235 9462/FIP-101776</p>	<p><b>APPLICATIONS:</b> Ridewell 1003589274C</p>		

BELLOWS <b>1T15V8</b>	AON <b>W01-358-9275</b>	C01-358-5105	19.26	Composite
<p>CROSS SECTION BEAD PLATE TOP PISTON BOTTOM</p>	<p>3235 9462/FIP-101776</p>	<p><b>APPLICATIONS:</b> Ridewell 1003589275C</p>		

BELLOWS <b>1T15V8</b>	AON <b>W01-358-9470</b>	C01-358-5105	16.18	Composite
<p>CROSS SECTION BEAD PLATE TOP PISTON BOTTOM</p>	<p>3253 9532/NAD-29827</p> <p>ORDER NO. WC1-358-1619</p>	<p>BRACKET <b>WC1-358-3887</b></p> <p><b>APPLICATIONS:</b> Holland (Neway) 90557145 (AD-246) Holland (Neway) 90557211 (2 bolt mounting on piston)</p>		

BELLOWS <b>1T15V8</b>	AON <b>W01-358-9471</b>	C01-358-5105	17.77	Composite
<p>CROSS SECTION BEAD PLATE TOP PISTON BOTTOM</p>	<p>3253 9540/NAD-29828</p> <p>ORDER NO. WC1-358-0664</p>	<p>BRACKET <b>WC1-358-3887</b></p> <p><b>APPLICATIONS:</b> Holland (Neway) (AD-123/246-10) 90557146 90557182 (no bracket) 90557177 (special lower connection) Holland (Neway) 90557212 (146) Holland (Neway) 90557214 (182) (2 bolt mounting on piston)</p>		

BELLOWS <b>1T15V8</b>	AON <b>W01-358-9472</b>	C01-358-5105	16.20	Composite
<p>CROSS SECTION BEAD PLATE TOP PISTON BOTTOM</p>	<p>3253 9544/NAD-29826</p> <p>ORDER NO. WC1-358-0666</p>	<p>BRACKET <b>WC1-358-3887</b></p> <p><b>APPLICATIONS:</b> Holland (Neway) 90557147 (AD-123/246-6.5 &amp; 8.75) 90557213 (147) (2 bolt mounting on piston) 90557178-Ford (special lower connection)</p>		

BELLOWS <b>1T15V8</b>	AON <b>W01-358-9473</b>	C01-358-5105	18.04	Composite
<p>CROSS SECTION BEAD PLATE TOP PISTON BOTTOM</p>	<p>3253 9540/NAD-29828</p> <p>ORDER NO. WC1-358-0664</p>	<p>BRACKET <b>WC1-358-3887</b></p> <p><b>APPLICATIONS:</b> Holland (Neway) 90557152 90557179 (no bracket) 90557215 (152) 90557216 (179) (2 bolt mounting on piston)</p>		

**HARDWARE KEY**

- Bolt or Stud 1/2-13
- ⊗ Air Inlet 1/4 N.P.T.
- ⊗ Combination Stud/Air Inlet Stud Outside Thread is 3/4-16 Pistons
- ⊗ Exception to Standard Stud/Air Inlet Stud Inside Thread of 1/4 N.P.T.
- ▲ No Alignment Specified-Center Stud Mounting is Standard
- ⊗ Threaded Hole 3/8-16 Blind Nut on Bead Plates 1/2-13 Pistons

BELLOWS <b>1T15V8</b>	AON <b>W01-358-9491</b>	C01-358-5105 18.44 Aluminum
CROSS SECTION	BEAD PLATE TOP	PISTON BOTTOM
BRACKET <b>WC1-358-3887</b>		
<b>APPLICATIONS:</b> Holland (Neway) 90557206 90557213 REPLACEMENT PISTON COMES WITHOUT STUDS Order No. WC1-358-0651		

BELLOWS <b>1T15V8</b>	AON <b>W01-358-9501</b>	C01-358-5105 17.58 Composite
CROSS SECTION	BEAD PLATE TOP	PISTON BOTTOM
<b>APPLICATIONS:</b> Holland 90557214 REPLACEMENT PISTON COMES WITHOUT STUDS ORDER NO. WC1-358-9453		

BELLOWS <b>1T15V8</b>	AON <b>W01-358-9502</b>	C01-358-5105 16.70 Composite
CROSS SECTION	BEAD PLATE TOP	PISTON BOTTOM
<b>APPLICATIONS:</b> Holland 90557211 REPLACEMENT PISTON COMES WITHOUT STUDS ORDER NO. WC1-358-9452 <b>OBsolete: NO LONGER AVAILABLE</b>		

BELLOWS <b>1T15V8</b>	AON <b>W01-358-9504</b>	C01-358-5105 17.91 Composite
CROSS SECTION	BEAD PLATE TOP	PISTON BOTTOM
<b>APPLICATIONS:</b> Holland 90557216 ORDER NO. WC1-358-9453		

BELLOWS <b>1T15V11</b>	AON <b>W01-358-9250</b>	C01-358-5133 23.57 Aluminum
CROSS SECTION	BEAD PLATE TOP	PISTON BOTTOM
<b>APPLICATIONS:</b> Ridewell 1003589250C Silent Drive ORDER NO. WC1-358-0680		

BELLOWS <b>1T15VMR8</b>	AON <b>W01-358-9865</b>	C01-358-5085 14.55 Composite
CROSS SECTION	BEAD PLATE TOP	PISTON BOTTOM
<b>APPLICATIONS:</b> Hendrickson 67043-2		

BELLOWS <b>1T15VMR8</b>	AON <b>W01-358-9866</b>	C01-358-5085 18.00 Composite
CROSS SECTION	BEAD PLATE TOP	PISTON BOTTOM
<b>APPLICATIONS:</b> Hendrickson 67391-2		

BELLOWS <b>1T15VMW8</b>	AON <b>W01-358-6258</b>	C01-358-5087 14.54 Composite
CROSS SECTION	BEAD PLATE TOP	PISTON BOTTOM
ORDER NO. WC1-358-1654 <b>APPLICATIONS:</b> Arvin Meritor 21227892 FS25		

BELLOWS <b>1T15VP4</b>	AON <b>W01-358-8800</b>	C01-358-5090 21.50 Steel
CROSS SECTION	BEAD PLATE TOP	PISTON BOTTOM
Order No. WC1-358-1649 <b>APPLICATIONS:</b> Hendrickson Trailer S-25559		

BELLOWS <b>1T15VP4</b>	AON <b>W01-358-9270</b>	C01-358-5090 14.27 Aluminum
CROSS SECTION	BEAD PLATE TOP	PISTON BOTTOM
ORDER NO. WC1-358-1613 <b>APPLICATIONS:</b> Hendrickson S-20010 (HT230T) ref.S21208 (different bead plate) Also replaces 1T15VM-4.0 <b>REPLACES 1T15VM4</b>		

**HARDWARE KEY**

- Bolt or Stud 1/2-13
- ⊗ Air Inlet 1/4 N.P.T.
- ⊗ Combination Stud/Air Inlet Stud Outside Thread is 3/4-16 Pistons
- ⊗ Exception to Standard Stud/Air Inlet Stud Inside Thread of 1/4 N.P.T.
- ▲ No Alignment Specified-Center Stud Mounting is Standard
- ⊗ Threaded Hole 3/8-16 Blind Nut on Bead Plates 1/2-13 Pistons

BELLOWS <b>1T15XBZR7.5</b>	AON <b>W01-358-9780</b>	C01-358-0572	13.24	Composite
<p>CROSS SECTION</p>	<p>BEAD PLATE TOP</p>	<p>PISTON BOTTOM</p>	<p><b>3191</b>      <b>9527/NAD-27265</b> PLASTIC</p> <p>Order No. WC1-358-1627</p>	
<p><b>APPLICATIONS:</b> Freightliner 16-13810-000 (composite) Freightliner 681-320-0017 (aluminum) - see W01-358-9781 Freightliner Piston 16-1673-000 (steel) - see W01-358-9782 A16-18335-000 A16-18335-001</p> <p><b>REPLACES 1T15ZR6</b></p>				

BELLOWS <b>1T15XBZR7.5</b>	AON <b>W01-358-9781</b>	C01-358-0572	17.00	Aluminum
<p>CROSS SECTION</p>	<p>BEAD PLATE TOP</p>	<p>PISTON BOTTOM</p>	<p><b>3191</b>      <b>9604/NAD-30174</b></p> <p>Order No. WC1-358-1624</p>	
<p><b>APPLICATIONS:</b> Freightliner 681-320-0017, A16-14004-000 (aluminum) A16-17574-001 (w/o bracket) A16-17574-002 (w/o bracket) Freightliner Piston 16-13840-000 (composite) - see W01-358-9780 Freightliner Piston 16-16773-000 (steel) - see W01-358-9782 A16-17574-001 A16-17574-002</p> <p><b>REPLACES 1T15ZR6</b></p>				

BELLOWS <b>1T15XBZR7.5</b>	AON <b>W01-358-9782</b>	C01-358-0572	21.00	Steel
<p>CROSS SECTION</p>	<p>BEAD PLATE TOP</p>	<p>PISTON BOTTOM</p>	<p><b>3191</b>      <b>9676/ NAD-31612</b></p> <p>ORDER NO. N/A</p>	
<p><b>APPLICATIONS:</b> Freightliner Custom Chassis 16-16773-000 (steel) 681-320-0017 (aluminum) - see W01-358-9781 16-13810-000 (composite) - see W01-358-9780</p> <p><b>REPLACES 1T15ZR6</b></p>				

BELLOWS <b>1T15XMR7</b>	AON <b>W01-358-8829</b>	C01-358-1179	11.90	Composite
<p>CROSS SECTION</p>	<p>BEAD PLATE TOP</p>	<p>PISTON BOTTOM</p>	<p><b>3254</b>      <b>4008/FIP-101526</b></p> <p>BRACKET <b>WC1-358-3873</b></p>	
<p><b>APPLICATIONS:</b> Volvo 3934699 Volvo 8079902</p> <p><b>REPLACES 1T15M6</b></p>				

BELLOWS <b>1T15XMR7</b>	AON <b>W01-M58-8463</b>	C01-358-1179	14.70	Composite
<p>CROSS SECTION</p>	<p>BEAD PLATE TOP</p>	<p>PISTON BOTTOM</p>	<p><b>2959</b>      <b>4008/FIP-101526</b></p> <p>BRACKET <b>70-3582-6070</b></p>	
<p><b>APPLICATIONS:</b> Volvo 20733034 Goodyear 1R12-647</p>				

BELLOWS <b>1T15XMR7</b>	AON <b>W01-M58-8468</b>	C01-358-1179	11.20	Composite
<p>CROSS SECTION</p>	<p>BEAD PLATE TOP</p>	<p>PISTON BOTTOM</p>	<p><b>2960</b>      <b>4008/FIP-101526</b></p>	
<p><b>APPLICATIONS:</b> Volvo 21132005 Goodyear 1R12-654</p>				

BELLOWS <b>1T15XNR5</b>	AON <b>W01-358-9648</b>	C01-358-1178	12.37	Composite
<p>CROSS SECTION</p>	<p>BEAD PLATE TOP</p>	<p>PISTON BOTTOM</p>	<p><b>3315</b>      <b>4008/FIP-101526</b></p> <p>BRACKET <b>70-3582-6047</b></p>	
<p><b>APPLICATIONS:</b> Navistar 2027911C1 &amp; C2</p> <p><b>REPLACES 1T15M8</b></p>				

BELLOWS <b>1T15XR9</b>	AON <b>W01-358-1190</b>	C01-358-1180	12.75	Composite
<p>CROSS SECTION</p>	<p>BEAD PLATE TOP</p>	<p>PISTON BOTTOM</p>	<p><b>2883</b>      <b>4008/FIP-101526</b></p>	
<p><b>APPLICATIONS:</b> Bead plate Bracket (Double Hole) 70-358-6064 Navistar 3541732C1 Goodyear 1R12-523</p> <p><b>REPLACES W01-358-9876</b></p>				

BELLOWS <b>1T15XR9</b>	AON <b>W01-358-1191</b>	C01-358-1180	12.20	Composite
<p>CROSS SECTION</p>	<p>BEAD PLATE TOP</p>	<p>PISTON BOTTOM</p>	<p><b>2942</b>      <b>4008/FIP-101526</b></p>	
<p><b>APPLICATIONS:</b> Bead plate Bracket (Single Hole) 70-358-6063 Navistar 3541731C1 Goodyear 1R12-432</p> <p><b>REPLACES W01-358-9875</b></p>				

BELLOWS <b>1T15XR9</b>	AON <b>W01-358-1192</b>	C01-358-1180	12.20	Composite
<p>CROSS SECTION</p>	<p>BEAD PLATE TOP</p>	<p>PISTON BOTTOM</p>	<p><b>2942</b>      <b>4008/FIP-101526</b></p>	
<p><b>APPLICATIONS:</b> Navistar 3691773C1</p>				

**HARDWARE KEY**

- Bolt or Stud 1/2-13
- ⊗ Air Inlet 1/4 N.P.T.
- ⊗ Combination Stud/Air Inlet Stud Outside Thread is 3/4-16 Pistons
- ⊗ Exception to Standard Stud/Air Inlet Stud Inside Thread of 1/4 N.P.T.
- ▲ No Alignment Specified-Center Stud Mounting is Standard
- ⊗ Threaded Hole 3/8-16 Blind Nut on Bead Plates 1/2-13 Pistons

BELLOWS <b>1T17B5</b>	AON <b>W01-358-8631</b>	C01-358-0458	25.45	Steel
			<b>APPLICATIONS:</b> Watson & Chalin AS-0098-01F  Order No. WC1-358-1649	

BELLOWS <b>1T17B5</b>	AON <b>W01-358-8723</b>	C01-358-0458	15.24	Aluminum
			<b>APPLICATIONS:</b> Ridewell 1001R13087 Ridewell 1001R13097  ORDER NO. WC1-358-1635	

BELLOWS <b>1T17B5</b>	AON <b>W01-358-8740</b>	C01-358-0458	15.22	Aluminum
			<b>APPLICATIONS:</b> Reyco 23433-01  ORDER NO. WC1-358-1613	

BELLOWS <b>1T17B5</b>	AON <b>W01-358-8752</b>	C01-358-0458	15.29	Aluminum
			<b>APPLICATIONS:</b> Watson & Chalin AS-0084 Ridewell 1003588752C Suspensions Inc. 201642 [piston mounting may vary with GY bag-787 BC]  Order No. WC1-358-1613	

BELLOWS <b>1T17B5</b>	AON <b>W01-358-8753</b>	C01-358-0458	15.35	Aluminum
			<b>APPLICATIONS:</b> Ridewell 1003588753C Watson & Chalin AS-0098  Order No. WC1-358-1613	

BELLOWS <b>1T17B5</b>	AON <b>W01-358-8755</b>	C01-358-0458	17.00	Aluminum
			<b>APPLICATIONS:</b> Hendrickson Trailer S22045 (HK190T) Hendrickson Trailer Prototype C21623  ORDER NO. WC1-358-1610	

BELLOWS <b>1T17B5</b>	AON <b>W01-358-8782</b>	C01-358-0458	15.56	Aluminum
			<b>APPLICATIONS:</b> Ridewell 1001R13109G  ORDER NO. WC1-358-1635	

BELLOWS <b>1T17B7</b>	AON <b>W01-358-8720</b>	C01-358-0463	22.27	Composite
			<b>APPLICATIONS:</b> Reyco 22747-01  ORDER NO. WC1-358-1613	

BELLOWS <b>1T17B11</b>	AON <b>W01-358-8744</b>	C01-358-0459	16.47	Composite
			<b>APPLICATIONS:</b> Holland (Neway) 90557243  ORDER NO. WC1-358-0664	

BELLOWS <b>1T17B11</b>	AON <b>W01-358-8746</b>	C01-358-0459	15.97	Composite
			<b>APPLICATIONS:</b> Holland (Neway) 90557235  ORDER NO. WC1-358-1619	

**HARDWARE KEY**  
 ● Bolt or Stud 1/2-13      ⊗ Air Inlet 1/4 N.P.T.  
 ⊗ Combination Stud/Air Inlet Stud Outside Thread is 3/4-16 Pistons  
 ⊗ Exception to Standard Stud/Air Inlet Stud Inside Thread of 1/4 N.P.T.  
 ▲ No Alignment Specified-Center Stud Mounting is Standard  
 ⊕ Threaded Hole 3/8-16 Blind Nut on Bead Plates 1/2-13 Pistons

BELLOWS <b>1T17B11</b>	AON <b>W01-358-8748</b>	C01-358-0459	16.01	Composite
<p>CROSS SECTION</p>	<p>BEAD PLATE TOP</p>	<p>PISTON BOTTOM</p>	<p><b>APPLICATIONS:</b> Holland (Neway) 90557167 (AR250-14 &amp; 15)</p> <p>ORDER NO. WC1-358-1619</p>	

BELLOWS <b>1T17B11</b>	AON <b>W01-358-8749</b>	C01-358-0459	17.95	Composite
<p>CROSS SECTION</p>	<p>BEAD PLATE TOP</p>	<p>PISTON BOTTOM</p>	<p><b>APPLICATIONS:</b> Holland (Neway) 90557168 (AR250-12,16,17)</p> <p>ORDER NO. WC1-358-0664</p>	

BELLOWS <b>1T17BB2</b>	AON <b>W01-358-8729</b>	C01-358-0454	13.15	Composite
<p>CROSS SECTION</p>	<p>BEAD PLATE TOP</p>	<p>PISTON BOTTOM</p>	<p><b>APPLICATIONS:</b> Meritor 202796 (GY 1R13-130)</p> <p>Order No. WC1-358-1644</p>	

BELLOWS <b>1T17BM6</b>	AON <b>W01-358-8673</b>	C01-358-0420	20.50	Aluminum
<p>CROSS SECTION</p>	<p>BEAD PLATE TOP</p>	<p>PISTON BOTTOM</p>	<p><b>APPLICATIONS:</b> Hendrickson 66643-002</p>	

BELLOWS <b>1T17BP17</b>	AON <b>W01-358-8724</b>	C01-358-0467	38.94	Steel
<p>CROSS SECTION</p>	<p>BEAD PLATE TOP</p>	<p>PISTON BOTTOM</p>	<p><b>APPLICATIONS:</b> Hendrickson Trailer S22697</p>	

**HARDWARE KEY**

- Bolt or Stud 1/2-13
- ⊗ Air Inlet 1/4 N.P.T.
- ⊗ Combination Stud/Air Inlet Stud Outside Thread is 3/4-16 Pistons
- ⊗ Exception to Standard Stud/Air Inlet Stud Inside Thread of 1/4 N.P.T.
- ▲ No Alignment Specified-Center Stud Mounting is Standard
- ⊗ Threaded Hole 3/8-16 Blind Nut on Bead Plates 1/2-13 Pistons

BELLOWS <b>1T17BV3</b>	AON <b>W01-358-8616</b>	C01-358-0455	13.83	Composite
<p>CROSS SECTION</p>	<p>BEAD PLATE TOP</p>	<p>PISTON BOTTOM</p>	<p><b>APPLICATIONS:</b></p> <p>Order No. WC1-358-1652</p>	

BELLOWS <b>1T17C3</b>	AON <b>W01-358-8737</b>	C01-358-0469	17.00	Composite
<p>CROSS SECTION</p>	<p>BEAD PLATE TOP</p>	<p>PISTON BOTTOM</p>	<p><b>APPLICATIONS:</b> Holland (Neway) 90557272 (NS225,NS450, WN225, NSH450)</p> <p>ORDER NO. WC1-358-0667</p>	

BELLOWS <b>1T17C3</b>	AON <b>W01-358-8738</b>	C01-358-0469	12.82	Composite
<p>CROSS SECTION</p>	<p>BEAD PLATE TOP</p>	<p>PISTON BOTTOM</p>	<p><b>APPLICATIONS:</b> Holland (Neway) 90557271 (NSH225, NSB225, RLU250)</p> <p>ORDER NO. WC1-358-0667</p>	

BELLOWS <b>1T17C6</b>	AON <b>W01-358-8637</b>	C01-358-0466	17.50	Aluminum
<p>CROSS SECTION</p>	<p>BEAD PLATE TOP</p>	<p>PISTON BOTTOM</p>	<p><b>APPLICATIONS:</b> Watson &amp; Chalin AS-0107</p> <p>Order No. WC1-358-1613</p>	

BELLOWS <b>1T17C8</b>	AON <b>W01-358-8109</b>	C01-358-0416	20.90	Composite
<p>CROSS SECTION</p>	<p>BEAD PLATE TOP</p>	<p>PISTON BOTTOM</p>	<p><b>APPLICATIONS:</b> Hendrickson 67234-002</p>	

BELLOWS <b>1T17C8</b>	AON <b>W01-M58-8712</b>	C01-M58-0475	19.68	Aluminum
<p>CROSS SECTION</p>	<p>BEAD PLATE TOP</p>	<p>PISTON BOTTOM</p>	<p>3739</p> <p>9690/NAD-28840</p> <p>Order No. N/A</p>	<p><b>APPLICATIONS:</b> Hendrickson 59319-2</p>

BELLOWS <b>1T17CA3</b>	AON <b>W01-358-8614</b>	C01-358-0417	24.00	Steel
<p>CROSS SECTION</p>	<p>BEAD PLATE TOP</p>	<p>PISTON BOTTOM</p>	<p>3300</p> <p>9648/ NAD-31288</p> <p>ORDER NO. WC1-358-1649</p>	<p><b>APPLICATIONS:</b> Hendrickson Trailer S26773 Wilson Trailer</p>

BELLOWS <b>1T17CA5</b>	AON <b>W01-358-8709</b>	C01-358-0471	14.15	Composite
<p>CROSS SECTION</p>	<p>BEAD PLATE TOP</p>	<p>PISTON BOTTOM</p>	<p>3300</p> <p>9525/ NAD-26906</p> <p>ORDER NO. WC1-358-1609</p>	<p><b>APPLICATIONS:</b> Hendrickson Trailer S21800 (Intraax AA230) [8/97-up] Replaces W01-358-8751 (approx. 6/98)</p>

BELLOWS <b>1T17CA6.5</b>	AON <b>W01-358-8708</b>	C01-358-0473	15.20	Composite
<p>CROSS SECTION</p>	<p>BEAD PLATE TOP</p>	<p>PISTON BOTTOM</p>	<p>3300</p> <p>9537/ NAD-29798</p> <p>ORDER NO. WC1-358-1637</p>	<p><b>APPLICATIONS:</b> Hendrickson Trailer S21966 (HKA200 Special)</p>

BELLOWS <b>1T17CA6.5</b>	AON <b>W01-358-8713</b>	C01-358-0473	17.96	Composite
<p>CROSS SECTION</p>	<p>BEAD PLATE TOP</p>	<p>PISTON BOTTOM</p>	<p>3344</p> <p>9537/NAD-29798</p> <p>Order No. WC1-358-1637</p>	<p><b>APPLICATIONS:</b> Hendrickson Trailer S22948 (Van Traax) Prior to 9/99 - use 9525 piston with bumper spacer</p>

BELLOWS <b>1T17CA6.5</b>	AON <b>W01-358-8735</b>	C01-358-0473	17.00	Aluminum
<p>CROSS SECTION</p>	<p>BEAD PLATE TOP</p>	<p>PISTON BOTTOM</p>	<p>3302</p> <p>9603/ NAD-29630</p> <p>ORDER NO. WC1-358-1635</p>	<p><b>APPLICATIONS:</b> Granning 7901 [1T19F-7]</p> <p><b>REPLACES W01-681-8770</b></p>

BELLOWS <b>1T17CD3</b>	AON <b>W01-358-8617</b>	C01-358-0453	13.52	Composite
<p>CROSS SECTION</p>	<p>BEAD PLATE TOP</p>	<p>PISTON BOTTOM</p>	<p>3301</p> <p>9533/ NAD-30515</p> <p>ORDER NO. WC1-358-1635</p>	<p><b>APPLICATIONS:</b> Arvin Meritor A2258-E-1461 RHP-55 Arvin Meritor 202796 Ride Sentry</p>

BELLOWS <b>1T17CL5</b>	AON <b>W01-358-8710</b>	C01-358-0470	17.52	Aluminum
<p>CROSS SECTION</p>	<p>BEAD PLATE TOP</p>	<p>PISTON BOTTOM</p>	<p>3300</p> <p>9802/ NAD-27999</p> <p>ORDER NO. WC1-358-1611</p>	<p><b>APPLICATIONS:</b> Hendrickson Trailer S22046 (HK230) Approximate availability 1-98</p> <p><b>REPLACES W01-358-8756</b></p>

BELLOWS <b>1T17CL9.5</b>	AON <b>W01-358-9580</b>	C01-358-0452	18.87	Aluminum
<p>CROSS SECTION</p>	<p>BEAD PLATE TOP</p>	<p>PISTON BOTTOM</p>	<p>3244</p> <p>9689/NAD-28838</p> <p>Order No. WC1-358-1607</p>	<p><b>APPLICATIONS:</b> Hendrickson Trailer S20127 [HT-250U 9-006] [HT-250UY 9Y-006]</p> <p><b>REPLACES 1T15VLT10.5, 1T15V11 AND W01-358-9262</b></p>

BELLOWS <b>1T17CL9.5</b>	AON <b>W01-358-9581</b>	C01-358-0452	18.96	Aluminum
<p>CROSS SECTION</p>	<p>BEAD PLATE TOP</p>	<p>PISTON BOTTOM</p>	<p>3244</p> <p>9689/ NAD-28838</p> <p>ORDER NO. WC1-358-1607</p>	<p><b>APPLICATIONS:</b> Hendrickson Trailer S20414 [HT-250U (9-006)] [HT-250U-Y (9Y-006)]</p> <p><b>REPLACES 1T15VLT10.5 AND 1T15V11</b></p>

**HARDWARE KEY**

- Bolt or Stud 1/2-13
- ⊗ Air Inlet 1/4 N.P.T.
- ⊗ Combination Stud/Air Inlet Stud Outside Thread is 3/4-16 Pistons
- ⊗ Exception to Standard Stud/Air Inlet Stud Inside Thread of 1/4 N.P.T.
- ▲ No Alignment Specified-Center Stud Mounting is Standard
- ⊗ Threaded Hole 3/8-16 Blind Nut on Bead Plates 1/2-13 Pistons



BELLOWS <b>1T17DCJ8.5</b>	AON <b>W01-M58-8608</b>	C01-M58-2217	13.89	Composite
<p>CROSS SECTION      BEAD PLATE TOP      PISTON BOTTOM</p>	<p><b>APPLICATIONS:</b></p>			

BELLOWS <b>1T17GJ6</b>	AON <b>W01-358-8539</b>	C01-358-0394	30.60	Composite
<p>CROSS SECTION      BEAD PLATE TOP      PISTON BOTTOM</p>	<p><b>APPLICATIONS:</b> Dana/Spicer SR1VA101-1 SR1VA105</p>			

BELLOWS <b>1T19L3</b>	AON <b>W01-358-8760</b>	C01-358-0526	19.03	Aluminum
<p>CROSS SECTION      BEAD PLATE TOP      PISTON BOTTOM</p>	<p><b>APPLICATIONS:</b> Granning 7593</p>			

BELLOWS <b>1T19L5</b>	AON <b>W01-358-8500</b>	C01-358-5356	20.96	Aluminum
<p>CROSS SECTION      BEAD PLATE TOP      PISTON BOTTOM</p>	<p><b>APPLICATIONS:</b> Rowe RV ASC1000/ ASC1001ASC1002/ ASC1003 Spartan</p>			

BELLOWS <b>1T19L5</b>	AON <b>W01-358-9200</b>	C01-358-5356	21.74	Aluminum
<p>CROSS SECTION      BEAD PLATE TOP      PISTON BOTTOM</p>	<p><b>APPLICATIONS:</b> Hendrickson Trailer S3839 Ridewell 1003589200C Mexican De Autobus Front-Rear Tag</p>			

BELLOWS <b>1T19L5</b>	AON <b>W01-358-9206</b>	C01-358-5356	18.46	Aluminum
<p>CROSS SECTION      BEAD PLATE TOP      PISTON BOTTOM</p>	<p><b>APPLICATIONS:</b></p>			

BELLOWS <b>1T19L5</b>	AON <b>W01-358-9215</b>	C01-358-5356	21.31	Aluminum
<p>CROSS SECTION      BEAD PLATE TOP      PISTON BOTTOM</p>	<p><b>APPLICATIONS:</b> Hendrickson Trailer S3648</p>			

BELLOWS <b>1T19L5</b>	AON <b>W01-358-9218</b>	C01-358-5356	21.42	Aluminum
<p>CROSS SECTION      BEAD PLATE TOP      PISTON BOTTOM</p>	<p><b>APPLICATIONS:</b> Ridewell 1003589218C Holland (Neway) 90557209 Suspensions Inc. Watson &amp; Chalin AS-0073 Rowe RV ASC1000 / ASC1001 / ASC1002 / ASC1003 Spartan</p>			

BELLOWS <b>1T19L5</b>	AON <b>W01-358-9801</b>	C01-358-5356	21.47	Aluminum
<p>CROSS SECTION      BEAD PLATE TOP      PISTON BOTTOM</p>	<p><b>APPLICATIONS:</b></p>			

BELLOWS <b>1T19L7</b>	AON <b>W01-358-8778</b>	C01-358-0501	22.66	Aluminum
<p>CROSS SECTION      BEAD PLATE TOP      PISTON BOTTOM</p>	<p><b>APPLICATIONS:</b> Holland (Neway) 90557164</p>			

**HARDWARE KEY**

- Bolt or Stud 1/2-13
- ⊗ Air Inlet 1/4 N.P.T.
- ⊙ Combination Stud/Air Inlet Stud Outside Thread is 3/4-16 Pistons
- ⊙ Exception to Standard Stud/Air Inlet Stud Inside Thread of 1/4 N.P.T.
- ▲ No Alignment Specified-Center Stud Mounting is Standard
- ⊙ Threaded Hole 3/8-16 Blind Nut on Bead Plates 1/2-13 Pistons

BELLOWS <b>1T19L7</b>	AON <b>W01-358-8980</b>	C01-358-0501	21.20	Composite
			<b>APPLICATIONS:</b>	

BELLOWS <b>1T19L7</b>	AON <b>W01-358-9121</b>	C01-358-0501	21.73	Aluminum
			<b>APPLICATIONS:</b> Holland (Neway) 90557019, 90557052, 90557078, 90557083 90557110 (parallel alignment) R & S Truck & Body 1090023 Ridewell 1003589121C Sauer P50-733 Reyco 12882-02 Watson & Chalin AS-0013	

BELLOWS <b>1T19L7</b>	AON <b>W01-358-9135</b>	C01-358-0501	30.59	Aluminum
			<b>APPLICATIONS:</b> Dart 21-4048 Unit Rig 1016034	

BELLOWS <b>1T19L7</b>	AON <b>W01-358-9141</b>	C01-358-0501	22.50	Aluminum
			<b>APPLICATIONS:</b> Neway 90557110	

BELLOWS <b>1T19L7</b>	AON <b>W01-358-9144</b>	C01-358-0501	24.20	Aluminum
			<b>APPLICATIONS:</b> Holland (Neway) 90557155	

BELLOWS <b>1T19L7</b>	AON <b>W01-358-9148</b>	C01-358-0501	20.89	Aluminum
			<b>APPLICATIONS:</b> Peerless 0550-00070	

Order No. WC1-358-9450

BELLOWS <b>1T19L7</b>	AON <b>W01-358-9149</b>	C01-358-0501	21.80	Aluminum
			<b>APPLICATIONS:</b> City Welding Peerless 0550-00010	

Order No. WC1-358-9450

BELLOWS <b>1T19L7</b>	AON <b>W01-358-9177</b>	C01-358-0501	21.76	Aluminum
			<b>APPLICATIONS:</b> Hendrickson Trailer S2065 R & S Truck & Body 1090216 Holland (Neway) 90557003 Ridewell 1003589177C Columbia Trailer	

Order No. WC1-358-9450

BELLOWS <b>1T19L7</b>	AON <b>W01-358-9221</b>	C01-358-0497	21.36	Aluminum
			<b>APPLICATIONS:</b> Load Air P60733	

Order No. WC1-358-9450

BELLOWS <b>1T19L7</b>	AON <b>W01-358-9280</b>	C01-358-0501	20.13	Composite
			<b>APPLICATIONS:</b>	

**HARDWARE KEY**

- Bolt or Stud 1/2-13
- ⊗ Air Inlet 1/4 N.P.T.
- ⊗ Combination Stud/Air Inlet Stud Outside Thread is 3/4-16 Pistons
- ⊗ Exception to Standard Stud/Air Inlet Stud Inside Thread of 1/4 N.P.T.
- ▲ No Alignment Specified-Center Stud Mounting is Standard
- ⊗ Threaded Hole 3/8-16 Blind Nut on Bead Plates 1/2-13 Pistons

PRIMARY TRUCK & TRAILER AXLE

BELLOWS <b>1T19L7</b>	AON <b>W01-358-9811</b>	C01-358-0501	19.56	Aluminum
			<b>APPLICATIONS:</b> Rowe Truck ASCC2000 Ride	
CROSS SECTION	BEAD PLATE TOP	PISTON BOTTOM	Order No. WC1-358-0631	

BELLOWS <b>1T19L9</b>	AON <b>W01-358-8779</b>	C01-358-1169	20.20	Aluminum
			<b>APPLICATIONS:</b> Holland (Neway) 90557163	
CROSS SECTION	BEAD PLATE TOP	PISTON BOTTOM	<b>OBSOLETE: NO LONGER AVAILABLE</b>	

BELLOWS <b>1T19L9</b>	AON <b>W01-358-8780</b>	C01-358-1169	19.90	Aluminum
			<b>APPLICATIONS:</b> Holland (Neway) 90557162	
CROSS SECTION	BEAD PLATE TOP	PISTON BOTTOM	Order No. WC1-358-9450	

BELLOWS <b>1T19L9</b>	AON <b>W01-358-8781</b>	C01-358-1169	19.89	Composite
			<b>APPLICATIONS:</b> Holland (Neway) 90557205	
CROSS SECTION	BEAD PLATE TOP	PISTON BOTTOM	Order No. WC1-358-0528	

BELLOWS <b>1T19L9</b>	AON <b>W01-358-9134</b>	C01-358-1169	19.88	Aluminum
			<b>APPLICATIONS:</b> Holland (Neway) 90557125 (AR-80-9) (AR-80-9WST)	
CROSS SECTION	BEAD PLATE TOP	PISTON BOTTOM	Order No. WC1-358-9450	

BELLOWS <b>1T19L9</b>	AON <b>W01-358-9138</b>	C01-358-1169	20.03	Aluminum
			<b>APPLICATIONS:</b> Holland (Neway) 90557111 (AR-80-9FM)	
CROSS SECTION	BEAD PLATE TOP	PISTON BOTTOM	Order No. WC1-358-9450	

BELLOWS <b>1T19L11</b>	AON <b>W01-358-8792</b>	C01-358-0525	23.91	Aluminum
			<b>APPLICATIONS:</b> Aluminum version of W01-358-9122	
CROSS SECTION	BEAD PLATE TOP	PISTON BOTTOM	Order No. WC1-358-1640	

BELLOWS <b>1T19L11</b>	AON <b>W01-358-8796</b>	C01-358-0525	19.92	Composite
			<b>APPLICATIONS:</b> Holland (Neway) 90557283 RL300	
CROSS SECTION	BEAD PLATE TOP	PISTON BOTTOM	<b>OBSOLETE: NO LONGER AVAILABLE</b>	

BELLOWS <b>1T19L11</b>	AON <b>W01-358-9122</b>	C01-358-0525	23.11	Composite
			<b>APPLICATIONS:</b> Hendrickson Trailer S3467, S3830 Holland (Neway) 90557020, 90557071, 90557076, 90557077 Hendrickson Can. B-12514-008, B-12514-010 Porcupine, Reyco 12883-02, Sauer P50-732 Ridewell 1003589122C, Temisko, Watson & Chalin AS-0023 Holland (Neway) 90557185 (parallel align.)	
CROSS SECTION	BEAD PLATE TOP	PISTON BOTTOM	Order No. WC1-358-0528	

BELLOWS <b>1T19L11</b>	AON <b>W01-358-9156</b>	C01-358-0525	21.32	Composite
			<b>APPLICATIONS:</b> City Welding Peerless 0550-00080 Hendrickson Trailer S7128	
CROSS SECTION	BEAD PLATE TOP	PISTON BOTTOM	Order No. WC1-358-0528	

**HARDWARE KEY**  
 ● Bolt or Stud 1/2-13      ⊗ Air Inlet 1/4 N.P.T.  
 ⊗ Combination Stud/Air Inlet Stud Outside Thread is 3/4-16 Pistons  
 ⊗ Exception to Standard Stud/Air Inlet Stud Inside Thread of 1/4 N.P.T.  
 ▲ No Alignment Specified-Center Stud Mounting is Standard  
 ⊕ Threaded Hole 3/8-16 Blind Nut on Bead Plates 1/2-13 Pistons

BELLOWS <b>1T19L11</b>	AON <b>W01-358-9158</b>	C01-358-0525	21.81	Composite
<p>CROSS SECTION</p>	<p>BEAD PLATE TOP</p>	<p>PISTON BOTTOM</p>	<p><b>APPLICATIONS:</b> Hendrickson Can. B-12514-004, B-12514-011 Holland (Neway) 90557005 Hendrickson Trailer S2063 Holland (Neway) 90557069 Peerless Ridewell 1003589158C Porcupine MFG.SV.# Neway 90044197</p>	

BELLOWS <b>1T19L11</b>	AON <b>W01-358-9804</b>	C01-358-0525	23.33	Aluminum
<p>CROSS SECTION</p>	<p>BEAD PLATE TOP</p>	<p>PISTON BOTTOM</p>	<p><b>APPLICATIONS:</b> Watson &amp; Chalin AS-0162-1G Ridewell 1000006 GoodYear 1R14-151</p>	

BELLOWS <b>1T19L11</b>	AON <b>W01-358-9985</b>	C01-358-0525	22.30	Composite
<p>CROSS SECTION</p>	<p>BEAD PLATE TOP</p>	<p>PISTON BOTTOM</p>	<p><b>APPLICATIONS:</b> Watson &amp; Chalin AS-0081</p>	

BELLOWS <b>1T19L11</b>	AON <b>W01-M58-6339</b>	C01-M58-0499	23.62	Aluminum
<p>CROSS SECTION</p>	<p>BEAD PLATE TOP</p>	<p>PISTON BOTTOM</p>	<p><b>APPLICATIONS:</b> R.O.R./Meritor 21215633, SAF 2 229 0003 00, Wewerler US 07345F Trailer 0036/58 E Viberti 128147122, SAE 8403/102, TEC 505859/01 Terberg 21071483, York 785170, CF Gomma 1T19E-2, 87408</p> <p><b>OBSELETE: NO LONGER AVAILABLE</b></p>	

BELLOWS <b>1T19L12</b>	AON <b>W01-358-5503</b>	C01-358-0522	21.77	Composite
<p>CROSS SECTION</p>	<p>BEAD PLATE TOP</p>	<p>PISTON BOTTOM</p>	<p>SERVICE ASSEMBLY <b>W01 M58 7238</b></p> <p><b>APPLICATIONS:</b> Holland (Neway) 90557200 Watson &amp; Chalin AS-0047</p>	

BELLOWS <b>1T19L12</b>	AON <b>W01-358-5505</b>	C01-358-0496	24.00	Aluminum
<p>CROSS SECTION</p>	<p>BEAD PLATE TOP</p>	<p>PISTON BOTTOM</p>	<p><b>APPLICATIONS:</b> Holland (Neway) 90557103</p>	

BELLOWS <b>1T19L12</b>	AON <b>W01-358-5508</b>	C01-358-0522	25.16	Aluminum
<p>CROSS SECTION</p>	<p>BEAD PLATE TOP</p>	<p>PISTON BOTTOM</p>	<p><b>APPLICATIONS:</b></p>	

BELLOWS <b>1T19L12</b>	AON <b>W01-358-5511</b>	C01-358-0522	21.96	Composite
<p>CROSS SECTION</p>	<p>BEAD PLATE TOP</p>	<p>PISTON BOTTOM</p>	<p><b>APPLICATIONS:</b> Holland (Neway) 90557102 Hendrickson Trailer S22173</p>	

BELLOWS <b>1T19L12</b>	AON <b>W01-358-5514</b>	C01-358-0496	21.87	Composite
<p>CROSS SECTION</p>	<p>BEAD PLATE TOP</p>	<p>PISTON BOTTOM</p>	<p><b>APPLICATIONS:</b> Watson &amp; Chalin AS-0047G Goodyear 1R14-170</p>	

BELLOWS <b>1T19L12</b>	AON <b>W01-358-9891</b>	C01-358-0522	24.50	Aluminum
<p>CROSS SECTION</p>	<p>BEAD PLATE TOP</p>	<p>PISTON BOTTOM</p>	<p><b>APPLICATIONS:</b> Holland (Neway) 90557218</p>	

**HARDWARE KEY**

- Bolt or Stud 1/2-13
- ⊗ Air Inlet 1/4 N.P.T.
- ⊙ Combination Stud/Air Inlet Stud Outside Thread is 3/4-16 Pistons
- ⊕ Exception to Standard Stud/Air Inlet Stud Inside Thread of 1/4 N.P.T.
- ▲ No Alignment Specified-Center Stud Mounting is Standard
- ⊖ Threaded Hole 3/8-16 Blind Nut on Bead Plates 1/2-13 Pistons

BELLOWS <b>1T19L14</b>	AON <b>W01-358-9264</b>	C01-358-0504	24.87	Aluminum
			<b>APPLICATIONS:</b> Hendrickson Trailer S13122 [HT250U(9-020)] Holland (Neway) 90557104 Watson Chalin AS-0063	
CROSS SECTION	BEAD PLATE TOP	PISTON BOTTOM	Order No. WC1-358-1602	

BELLOWS <b>1T19L14</b>	AON <b>W01-358-9915</b>	C01-358-0495	24.26	Aluminum
			<b>APPLICATIONS:</b> Holland (Neway) 90557104 Watson & Chalin AS-0063	
CROSS SECTION	BEAD PLATE TOP	PISTON BOTTOM	Order No. WC1-358-1602	

BELLOWS <b>1T19L16</b>	AON <b>W01-358-9896</b>	C01-358-0527	25.46	Aluminum
			<b>APPLICATIONS:</b> Neway 90557144 Rotate Piston: 90557133-28 Degrees RH 90557134-28 Degrees LH 90557148 Parallel	
CROSS SECTION	BEAD PLATE TOP	PISTON BOTTOM	Order No. WC1-358-1602	

BELLOWS <b>1T19L16</b>	AON <b>W01-358-9928</b>	C01-358-0527	25.40	Aluminum
			<b>APPLICATIONS:</b> Suspensions Inc. (Wabash) Hendrickson Trailer S20157	
CROSS SECTION	BEAD PLATE TOP	PISTON BOTTOM	Order No. WC1-358-1602	

BELLOWS <b>1T19LB8</b>	AON <b>W01-M58-8775</b>	C01-M58-0492	21.26	Aluminum
			<b>APPLICATIONS:</b> ROR SAF WEWELER 1R14-716	
CROSS SECTION	BEAD PLATE TOP	PISTON BOTTOM	Order No. WC1-358-1602	

BELLOWS <b>1T19LB12</b>	AON <b>W01-M58-6348</b>	C01-M58-1163	24.60	Aluminum
			<b>APPLICATIONS:</b>	
CROSS SECTION	BEAD PLATE TOP	PISTON BOTTOM	Order No. WC1-M58-1655	

BELLOWS <b>1T19LC5</b>	AON <b>W01-358-8092</b>	C01-358-5250	21.40	Aluminum
			<b>APPLICATIONS:</b> Ag Chem	
CROSS SECTION	BEAD PLATE TOP	PISTON BOTTOM	<b>OBSELETE: NO LONGER AVAILABLE</b>	

BELLOWS <b>1T19LC5</b>	AON <b>W01-M58-8798</b>	C01-M58-5346	14.36	Aluminum
			<b>APPLICATIONS:</b> John Deere AN205761	
CROSS SECTION	BEAD PLATE TOP	PISTON BOTTOM	Order No. WC1-358-1614	

BELLOWS <b>1T19LC6</b>	AON <b>W01-358-8091</b>	C01-358-5349	17.88	Composite
			<b>APPLICATIONS:</b> Hendrickson Trailer S20901 (Intraux 250) -Reuse metal disk Hendrickson Trailer S21784 w/ metal disk for piston support	
CROSS SECTION	BEAD PLATE TOP	PISTON BOTTOM	Order No. WC1-358-1614	

BELLOWS <b>1T19LC8</b>	AON <b>W01-358-8093</b>	C01-358-5350	21.17	Composite
			<b>APPLICATIONS:</b> Hendrickson Trailer S23748 (w/ disk S24443)	
CROSS SECTION	BEAD PLATE TOP	PISTON BOTTOM	ORDER NO. WC1-358-1614	

**HARDWARE KEY**

- Bolt or Stud 1/2-13
- ⊗ Air Inlet 1/4 N.P.T.
- ⊗ Combination Stud/Air Inlet Stud Outside Thread is 3/4-16 Pistons
- ⊗ Exception to Standard Stud/Air Inlet Stud Inside Thread of 1/4 N.P.T.
- ▲ No Alignment Specified-Center Stud Mounting is Standard
- ⊗ Threaded Hole 3/8-16 Blind Nut on Bead Plates 1/2-13 Pistons

**PRIMARY TRUCK & TRAILER AXLE**  
1T REVERSIBLE SLEEVE SPRINGS



BELLOWS <b>1T19LE8</b>	AON <b>W01-358-9825</b>	C01-358-0521	22.08	Aluminum	
 CROSS SECTION	 BEAD PLATE TOP	 PISTON BOTTOM	<b>APPLICATIONS:</b> Tuthill Granning 700136-01		

BELLOWS <b>1T19LE12</b>	AON <b>W01-358-8793</b>	C01-358-0517	22.82	Aluminum	
 CROSS SECTION	 BEAD PLATE TOP	 PISTON BOTTOM	<b>APPLICATIONS:</b> Holland (Neway) 90557270 AD-130		

BELLOWS <b>1T19LF7</b>	AON <b>W01-358-8774</b>	C01-358-0519	18.01	Composite	
 CROSS SECTION	 BEAD PLATE TOP	 PISTON BOTTOM	<b>APPLICATIONS:</b> Hendrickson Trailer S25873 Replacement piston comes without mounting plate Watson & Chalin AS-0159		

BELLOWS <b>1T19LG8</b>	AON <b>W01-358-5530</b>	C01-358-0562	19.13	Aluminum	
 CROSS SECTION	 BEAD PLATE TOP	 PISTON BOTTOM	<b>APPLICATIONS:</b> Neway 90557434		

BELLOWS <b>1T19ZK5.7</b>	AON <b>W01-358-5523</b>	C01-358-0513	29.20	Steel	
 CROSS SECTION	 BEAD PLATE TOP	 PISTON BOTTOM	<b>APPLICATIONS:</b> Hend. Trailer S-4771 Hend Canada B-12514-013 Tuthill-Reyco 23631-01 WatsonChalin AS-0039		

**HARDWARE KEY**

- Bolt or Stud 1/2-13
- ⊗ Air Inlet 1/4 N.P.T.
- ⊗ Combination Stud/Air Inlet Stud Outside Thread is 3/4-16 Pistons
- ⊗ Exception to Standard Stud/Air Inlet Stud Inside Thread of 1/4 N.P.T.
- ▲ No Alignment Specified-Center Stud Mounting is Standard
- ⊗ Threaded Hole 3/8-16 Blind Nut on Bead Plates 1/2-13 Pistons



**PRIMARY TRUCK & TRAILER AXLE**  
1T REVERSIBLE SLEEVE SPRINGS

BELLOWS <b>1T19ZK5.7</b>	AON <b>W01-358-8050</b>	C01-358-0513	25.00	Aluminum	
 CROSS SECTION	 BEAD PLATE TOP	 PISTON BOTTOM	<b>APPLICATIONS:</b> Hendrickson Trailer S4771 Hend. Canada B-12514-013 Tuthill-Reyco 23631-01 Watson & Chalin AS-0039		

BELLOWS <b>1T19ZK5.7</b>	AON <b>W01-358-8052</b>	C01-358-0513	29.55	Steel	
 CROSS SECTION	 BEAD PLATE TOP	 PISTON BOTTOM	<b>APPLICATIONS:</b> Hendrickson Can. B12514-012 Watson & Chalin AS-0078 Watson & Chalin AS-0039		

BELLOWS <b>1T19ZK5.7</b>	AON <b>W01-358-8053</b>	C01-358-0513	20.88	Steel	
 CROSS SECTION	 BEAD PLATE TOP	 PISTON BOTTOM	<b>APPLICATIONS:</b> Holland (Neway) 90557098 (ARDTB125-6A&6B)		

BELLOWS <b>1T26D7</b>	AON <b>W01-358-9310</b>	C01-358-5147	5.73	Aluminum	
 CROSS SECTION	 BEAD PLATE TOP	 PISTON BOTTOM	<b>APPLICATIONS:</b>		

BELLOWS <b>1T26D7</b>	AON <b>W01-358-9327</b>	C01-358-5147	5.63	Aluminum	
 CROSS SECTION	 BEAD PLATE TOP	 PISTON BOTTOM	<b>APPLICATIONS:</b>		

**PRIMARY TRUCK & TRAILER AXLE**  
1T REVERSIBLE SLEEVE SPRINGS



NOTES

<p>BELLOWS <b>1T66G11.8</b></p> <p>CROSS SECTION BEAD PLATE TOP PISTON BOTTOM</p>	<p>AON <b>W01-358-8984</b></p> <p>C01-358-0927 35.50 Steel</p>	<p><b>APPLICATIONS:</b> Wabash (Roadrailer) Rowe Truck ASC1400HL Ride</p> <p><b>REPLACES 1T19J6</b></p>
<p>BELLOWS <b>BRACKET</b></p> <p>CROSS SECTION BEAD PLATE TOP PISTON BOTTOM</p>	<p>AON <b>WC1-358-3874</b></p> <p>N/A 1.28 N/A</p>	<p>6013/NAD-33041</p> <p><b>APPLICATIONS:</b> Freightliner 16-17010-001 16-15762-000</p> <p><b>OBSOLETE: NO LONGER AVAILABLE</b></p>
<p>BELLOWS <b>BRACKET</b></p> <p>CROSS SECTION BEAD PLATE TOP PISTON BOTTOM</p>	<p>AON <b>WC1-358-3876</b></p> <p>N/A 1.39 N/A</p>	<p>6012/NAD-33042</p> <p><b>APPLICATIONS:</b> Freightliner 16-17010-002</p> <p><b>OBSOLETE: NO LONGER AVAILABLE</b></p>
<p>BELLOWS <b>BRACKET</b></p> <p>CROSS SECTION BEAD PLATE TOP PISTON BOTTOM</p>	<p>AON <b>WC1-358-3900</b></p> <p>N/A 1.58 N/A</p>	<p>6033/ NBD-13722</p> <p><b>APPLICATIONS:</b> Freightliner A16-14004-000 (Aluminum) 9781 Freightliner 16-13810-001 (Plastic) 9780 Add Bracket to 9780 or 9781</p>
<p>BELLOWS <b>BRACKET</b></p> <p>CROSS SECTION BEAD PLATE TOP PISTON BOTTOM</p>	<p>AON <b>WC1-358-3901</b></p> <p>N/A 2.02 N/A</p>	<p>6034/ NBD-13721</p> <p><b>APPLICATIONS:</b> Freightliner A16-14004-001 (Aluminum) Freightliner 16-13810-002 (Plastic) (Cabover) Add Bracket To 9780 or 9781</p>

**HARDWARE KEY**

- Bolt or Stud 1/2-13
- ⊗ Air Inlet 1/4 N.P.T.
- ⊗ Combination Stud/Air Inlet Stud Outside Thread is 3/4-16 Pistons
- ⊗ Exception to Standard Stud/Air Inlet Stud Inside Thread of 1/4 N.P.T.

- ▲ No Alignment Specified-Center Stud Mounting is Standard
- ⊗ Threaded Hole 3/8-16 Blind Nut on Bead Plates 1/2-13 Pistons

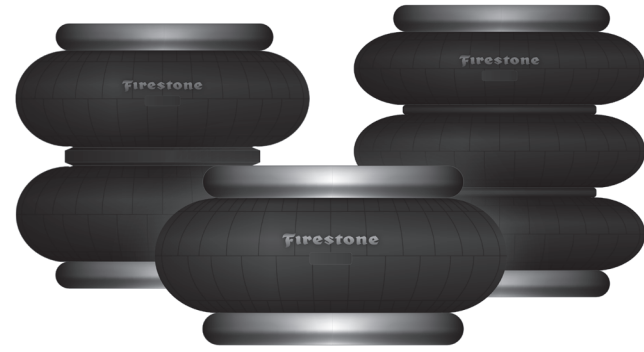

Firestone's convoluted Airide springs are available in three styles—single, double, or triple convoluted.

READING THE PARTS TABLE

<b>1</b> BELLOWS <b>218</b>	<b>2</b> AON <b>W01-358-7294</b>	<b>6</b> 14.6
<b>7</b> BEAD RING <b>WC1-358-3509</b>	<b>8</b> APPLICATIONS: Unit Rig 1016031 Dart 21-40061	<b>9</b> OBSOLETE

**1. Bellows Number**

Identifies the bellows, normally molded directly underneath the Firestone logo.

**2. Assembly Order Number (AON)**

Located on the label adhered to the bead plate. This number is used for ordering purposes.

**3. Cross Section View**

Includes dimensional information in inches for **uninflated** diameter and collapsed height, as well as hardware details. A bumper, shown in black, and bumper drawing number is also referenced, if applicable (i.e., 6395).

**4. Bead Plate Top View**

Identifies dimensional information in inches, mounting attachments, and the internal Firestone reference number for bead plate, stamped on bead plate top.

**5. Bead Plate Bottom View**

Identifies dimensional information in inches, mounting attachments, and the internal Firestone reference number for bead plate, stamped on bead plate bottom.

**6. Assembly Weight**

Total weight of the assembly in pounds.

**7. Assembly Components**

Part numbers for sub-components associated with the assembly.

**8. Applications**

Vehicle and suspension manufacturers' part numbers for the particular Airide spring.

**9. Assembly Notes**

Important information if an assembly has been obsoleted and if there is an exact replacement part available, or if it has replaced other parts.

AIR SPRING IDENTIFICATION

**Convoluted Air Springs**

To identify the exact style and part number to replace your current air spring, you need to identify the type of bellows, bead plates, and attaching hardware used, as well as determining whether the spring has an internal bumper. The steps below apply to all convoluted air spring styles (single, double, or triple).

**Assembly Order Number (AON)**

The quickest way to identify the air spring is to read the manufacturer or Firestone assembly order number, located on the label adhered to the bead plate.

**Bellows Number**

If the AON is illegible, read the part number molded on the bellows, normally directly under the Firestone name. If the number (20, 22, etc.) is present, refer to the corresponding bellows range in this guide to narrow down your search.

**Bead Plate**

Identify the 8-digit stamped bead plate number. Reference the last 4 digits to find possible matches. If the number is not legible, use the **bead plate diameter** measurement in this view to further distinguish between assemblies. Verify the alignment of mounting attachments.

**Air Spring Hardware**

To complete the parts identification, compare the metal bead plates and attaching hardware with the assemblies detailed in that same section of the guide. See illustrations below.

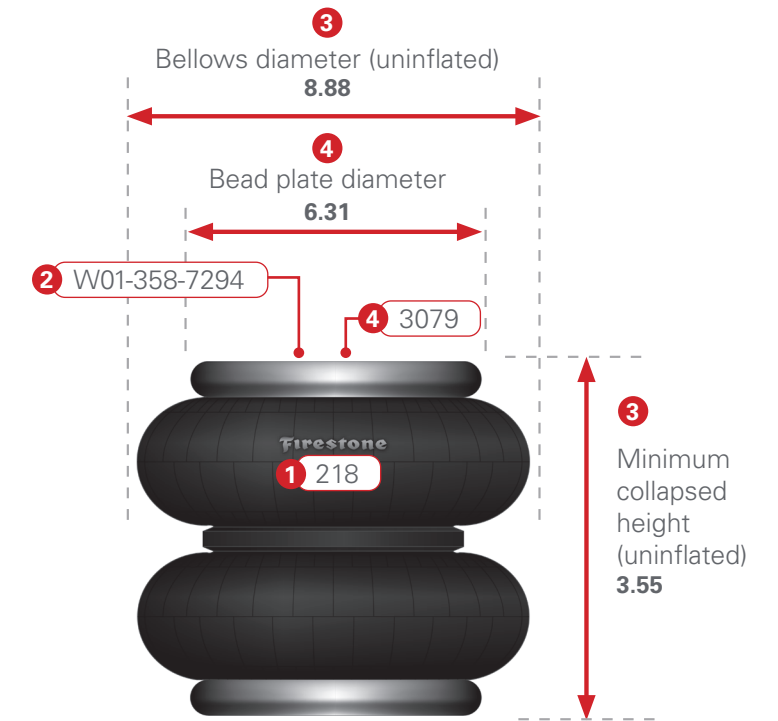

**Measure and Reference Cross Section View**

Should the bellows number be unreadable, you can determine the bellows type with two simple measurements. Open the air entrance and allow the bellows to assume its normal shape. Then, **measure the bead plate diameter** and **outer diameter of the bellows**. Compare these diameters with those listed in the bellows index (page 216) for the specific type of convoluted (single, double, or triple) bellows that you have. To determine if an **internal bumper** is present, measure the minimum collapsed height and compare it to the parts table.

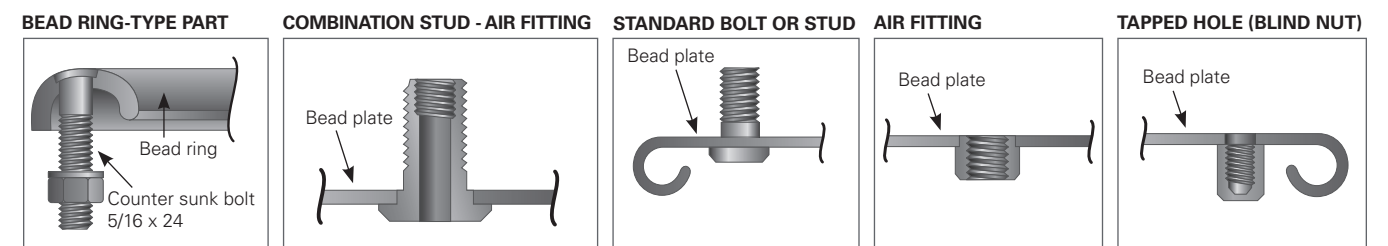



BELLOWS 16	AON W01-358-0510	2.60
<p>CROSS SECTION BEAD PLATE TOP BEAD PLATE BOTTOM</p>	<p><b>APPLICATIONS:</b></p>	

BELLOWS 16	AON W01-358-7001	2.57
<p>CROSS SECTION BEAD PLATE TOP BEAD PLATE BOTTOM</p>	<p><b>APPLICATIONS:</b></p>	

BELLOWS 19	AON W01-358-6994	11.42
<p>CROSS SECTION BEAD PLATE TOP BEAD PLATE BOTTOM</p>	<p><b>APPLICATIONS:</b> Capacity of Texas</p>	

BELLOWS 19	AON W01-358-7008	9.60
<p>CROSS SECTION BEAD PLATE TOP BEAD PLATE BOTTOM</p>	<p><b>APPLICATIONS:</b> Holland (Neway) 90557226</p>	

BELLOWS 19	AON W01-358-7009	11.16
<p>CROSS SECTION BEAD PLATE TOP BEAD PLATE BOTTOM</p>	<p><b>APPLICATIONS:</b> Holland (Neway) 90557002</p>	

**HARDWARE KEY**

- Bolt or Stud 1/2-13
- ⊗ Air Inlet 1/4 N.P.T.
- ⊙ Combination Stud/Air Inlet Stud Outside Thread is 3/4-16 Pistons
- ⊕ Exception to Standard Stud/Air Inlet Stud Inside Thread of 1/4 N.P.T.
- ▲ No Alignment Specified-Center Stud Mounting is Standard
- ⊖ Threaded Hole 3/8-16 Blind Nut on Bead Plates 1/2-13 Pistons

BELLOWS 19	AON W01-358-7011	9.92
<p>CROSS SECTION BEAD PLATE TOP BEAD PLATE BOTTOM</p>	<p><b>APPLICATIONS:</b></p>	

BELLOWS 19-.75	AON W01-358-7043	11.22
<p>CROSS SECTION BEAD PLATE TOP BEAD PLATE BOTTOM</p>	<p><b>APPLICATIONS:</b> Chalmers</p> <p><b>OBSOLETE: NO LONGER AVAILABLE</b></p>	

BELLOWS 113	AON W01-358-7103	14.11
<p>CROSS SECTION BEAD PLATE TOP BEAD PLATE BOTTOM</p>	<p><b>APPLICATIONS:</b> Peerless 0550-00015</p>	

BELLOWS 113	AON W01-358-7104	15.38
<p>CROSS SECTION BEAD PLATE TOP BEAD PLATE BOTTOM</p>	<p><b>APPLICATIONS:</b> Miscellaneous</p> <p><b>OBSOLETE: NO LONGER AVAILABLE</b></p>	

BELLOWS 113-.5	AON W01-358-7093	16.71
<p>CROSS SECTION BEAD PLATE TOP BEAD PLATE BOTTOM</p>	<p><b>APPLICATIONS:</b> American Carrier 8003-013</p>	

BELLOWS 113-1	AON W01-358-7094	16.41
	<p><b>APPLICATIONS:</b> Chalmers</p>	

BELLOWS 113-1	AON W01-358-7112	14.96
	<p><b>APPLICATIONS:</b> Holland (Neway) 90557028 Ridewell 1003587112C</p>	

BELLOWS 126	AON W01-358-7726	43.62
	<p><b>APPLICATIONS:</b> Air Suspended Fifth Wheel Tartan Transportation (Classic Ride)/Airglide</p>	

BELLOWS 150	AON W01-358-7462	6.28
	<p><b>APPLICATIONS:</b> Load Share</p>	

BELLOWS 20	AON W01-358-6856	8.06
	<p><b>APPLICATIONS:</b> Tuthill Granning 702932-01</p>	

**HARDWARE KEY**

- Bolt or Stud 1/2-13
- ⊗ Air Inlet 1/4 N.P.T.
- ⊗ Combination Stud/Air Inlet Stud Outside Thread is 3/4-16 Pistons
- ⊗ Exception to Standard Stud/Air Inlet Stud Inside Thread of 1/4 N.P.T.
- ▲ No Alignment Specified-Center Stud Mounting is Standard
- ⊗ Threaded Hole 3/8-16 Blind Nut on Bead Plates 1/2-13 Pistons

BELLOWS 20	AON W01-358-6884	8.28
	<p><b>APPLICATIONS:</b> Link 1103-0019</p>	

BELLOWS 20	AON W01-358-6890	7.27
	<p><b>APPLICATIONS:</b> Holland (Neway) 90557228 V-Steer 1 (Lift Bag)</p>	

BELLOWS 20	AON W01-358-6897	7.33
	<p><b>APPLICATIONS:</b> Watson &amp; Chalin AS-0058</p>	

BELLOWS 20	AON W01-358-6900	7.09
	<p><b>APPLICATIONS:</b> Ridewell</p>	

BELLOWS 20	AON W01-358-6902	8.29
	<p><b>APPLICATIONS:</b> Granning 4848 Hendrickson Trailer S2630 R &amp; S Truck &amp; Body 1027505 Ridewell 1003586902C American Carrier Suspensions Inc. 2000-42 Watson &amp; Chalin AS-0002</p>	

BELLOWS 20	AON W01-358-6905	8.53
<p>CROSS SECTION</p>	<p>3101 BEAD PLATE TOP</p>	<p>3100 BEAD PLATE BOTTOM</p>
<p><b>APPLICATIONS:</b> Hendrickson Trailer S3518 Hendrickson Trailer S5270 Hendrickson Can. 45843-1 Ridewell 1003586905C Silent Drive EZ Ride 8030120 Monaco Coach Watson &amp; Chalin AS-0020</p>		

BELLOWS 20	AON W01-358-6908	7.82
<p>CROSS SECTION</p>	<p>3101 BEAD PLATE TOP</p>	<p>3090 BEAD PLATE BOTTOM</p>
<p><b>APPLICATIONS:</b> Watson &amp; Chalin AS-0035</p>		

BELLOWS 20	AON W01-358-6910	7.00
<p>CROSS SECTION</p>	<p>3079 BEAD PLATE TOP</p>	<p>3090 BEAD PLATE BOTTOM</p>
<p><b>APPLICATIONS:</b> Granning 1371 Hendrickson Trailer S8768 Hendrickson Can. 45843-3 Ridewell 1003586910C Watson &amp; Chalin AS-0001</p>		

BELLOWS 20	AON W01-358-6926	8.02
<p>CROSS SECTION</p>	<p>3079 BEAD PLATE TOP</p>	<p>3100 BEAD PLATE BOTTOM</p>
<p><b>APPLICATIONS:</b> Load Share</p>		

BELLOWS 20	AON W01-358-6932	8.36
<p>CROSS SECTION</p>	<p>3148 BEAD PLATE TOP</p>	<p>3095 BEAD PLATE BOTTOM</p>
<p><b>APPLICATIONS:</b> Ridewell 1003586932C</p>		

BELLOWS 20	AON W01-358-6935	7.95
<p>CROSS SECTION</p>	<p>3079 BEAD PLATE TOP</p>	<p>3100 BEAD PLATE BOTTOM</p>
<p><b>APPLICATIONS:</b> Hendrickson Trailer S14318 HLM Lift Bag Hendrickson Aux. 003318 (metric version)</p>		

BELLOWS 20	AON W01-358-6940	8.58
<p>CROSS SECTION</p>	<p>3102 BEAD PLATE TOP</p>	<p>3099 BEAD PLATE BOTTOM</p>
<p><b>APPLICATIONS:</b> Histeer 10305</p>		

BELLOWS 20	AON W01-358-6941	8.31
<p>CROSS SECTION</p>	<p>3140 BEAD PLATE TOP</p>	<p>3099 BEAD PLATE BOTTOM</p>
<p><b>APPLICATIONS:</b> Histeer 10302</p>		

BELLOWS 20	AON W01-358-6949	7.90
<p>CROSS SECTION</p>	<p>3148 BEAD PLATE TOP</p>	<p>3095 BEAD PLATE BOTTOM</p>
<p><b>APPLICATIONS:</b> Load Air P-10872-A</p>		

BELLOWS 20	AON W01-358-7686	8.86
<p>CROSS SECTION</p>	<p>3148 BEAD PLATE TOP</p>	<p>3095 BEAD PLATE BOTTOM</p>
<p><b>APPLICATIONS:</b> Rowe Truck 0035 ASC2500 ASC1600</p>		

**HARDWARE KEY**

- Bolt or Stud 1/2-13
- ⊗ Air Inlet 1/4 N.P.T.
- ⊗ Combination Stud/Air Inlet Stud Outside Thread is 3/4-16 Pistons
- ⊗ Exception to Standard Stud/Air Inlet Stud Inside Thread of 1/4 N.P.T.

- ▲ No Alignment Specified-Center Stud Mounting is Standard
- ⊗ Threaded Hole 3/8-16 Blind Nut on Bead Plates 1/2-13 Pistons

BELLOWS 20	AON W01-358-7788	8.63
	<p><b>APPLICATIONS:</b> Watson &amp; Chalin AS-0088</p>	
BELLOWS 20	AON W01-358-7795	7.31
	<p><b>APPLICATIONS:</b> Hendrickson Trailer S14486 (lift bag) Hendrickson Aux. (Paralift, Paralift Ultra) Hendrickson Aux. 003317 (metric version)</p>	
BELLOWS 20	AON W01-358-7891	7.90
	<p><b>APPLICATIONS:</b> Hendrickson 5360</p>	
BELLOWS 20	AON W01-358-7892	7.98
	<p><b>APPLICATIONS:</b> Ridewell 1003587893C</p>	
BELLOWS 20-1	AON W01-358-6883	8.26
	<p><b>APPLICATIONS:</b> Watson &amp; Chalin AS-0092</p>	

**HARDWARE KEY**

- Bolt or Stud 1/2-13
- ⊗ Air Inlet 1/4 N.P.T.
- ⊗ Combination Stud/Air Inlet Stud Outside Thread is 3/4-16 Pistons
- ⊗ Exception to Standard Stud/Air Inlet Stud Inside Thread of 1/4 N.P.T.
- ▲ No Alignment Specified-Center Stud Mounting is Standard
- ⊗ Threaded Hole 3/8-16 Blind Nut on Bead Plates 1/2-13 Pistons

BELLOWS 20-1	AON W01-358-6886	8.06
	<p><b>APPLICATIONS:</b> Watson &amp; Chalin AS-0058-1F Tuthill-Reyco 701784-01</p>	
BELLOWS 20-1	AON W01-358-7897	7.57
	<p><b>APPLICATIONS:</b> Hendrickson Aux. 002878 (Lift Bag) Hendrickson Aux. (Pararev) Hendrickson Trailer S23114</p>	
BELLOWS 20-2	AON W01-358-5900	7.74
	<p><b>APPLICATIONS:</b> Link 1103-0059</p>	
BELLOWS 20-2	AON W01-358-6392	8.28
	<p><b>APPLICATIONS:</b> Arvin Meritor 2258-G-1489</p>	
BELLOWS 20-2	AON W01-358-6817	8.09
	<p><b>APPLICATIONS:</b> Ridewell 1003586817C</p>	

<p>BELLOWS 20-2</p> <p>CROSS SECTION</p> <p>BEAD PLATE TOP</p> <p>BEAD PLATE BOTTOM</p>	<p>AON <b>W01-358-6927</b></p> <p>8.02</p> <p><b>APPLICATIONS:</b> Reyco 12906-01</p>
<p>BELLOWS 20-2</p> <p>CROSS SECTION</p> <p>BEAD PLATE TOP</p> <p>BEAD PLATE BOTTOM</p>	<p>AON <b>W01-358-6943</b></p> <p>7.98</p> <p><b>APPLICATIONS:</b> Watson &amp; Chalin AS-0041 Van Raden Holland (Neway) 90557237 V-Steer II (Lift Bag)</p>
<p>BELLOWS 20-2</p> <p>CROSS SECTION</p> <p>BEAD PLATE TOP</p> <p>BEAD PLATE BOTTOM</p>	<p>AON <b>W01-358-6944</b></p> <p>8.64</p> <p><b>APPLICATIONS:</b> Histeer 10307 Suspensions Inc.</p>
<p>BELLOWS 20-2</p> <p>CROSS SECTION</p> <p>BEAD PLATE TOP</p> <p>BEAD PLATE BOTTOM</p>	<p>AON <b>W01-358-6945</b></p> <p>8.75</p> <p><b>APPLICATIONS:</b> Ridewell 1003586945C</p>
<p>BELLOWS 20-2</p> <p>CROSS SECTION</p> <p>BEAD PLATE TOP</p> <p>BEAD PLATE BOTTOM</p>	<p>AON <b>W01-358-6946</b></p> <p>8.84</p> <p><b>APPLICATIONS:</b> Ridewell 1003586946C</p>

**HARDWARE KEY**

- Bolt or Stud 1/2-13
- ⊗ Air Inlet 1/4 N.P.T.
- ⊗ Combination Stud/Air Inlet Stud Outside Thread is 3/4-16 Pistons
- ⊗ Exception to Standard Stud/Air Inlet Stud Inside Thread of 1/4 N.P.T.
- ▲ No Alignment Specified-Center Stud Mounting is Standard
- ⊗ Threaded Hole 3/8-16 Blind Nut on Bead Plates 1/2-13 Pistons

<p>BELLOWS 20-2</p> <p>CROSS SECTION</p> <p>BEAD PLATE TOP</p> <p>BEAD PLATE BOTTOM</p>	<p>AON <b>W01-358-6947</b></p> <p>8.68</p> <p><b>APPLICATIONS:</b> Hendrickson Trailer S8701 Ridewell 1003586947C</p>
<p>BELLOWS 20-2</p> <p>CROSS SECTION</p> <p>BEAD PLATE TOP</p> <p>BEAD PLATE BOTTOM</p>	<p>AON <b>W01-358-6948</b></p> <p>8.50</p> <p><b>APPLICATIONS:</b> Ridewell 1003586948C Silent Drive</p>
<p>BELLOWS 20-2</p> <p>CROSS SECTION</p> <p>BEAD PLATE TOP</p> <p>BEAD PLATE BOTTOM</p>	<p>AON <b>W01-358-6960</b></p> <p>8.39</p> <p><b>APPLICATIONS:</b> Granning 7025</p> <p><b>OBSELETE: NO LONGER AVAILABLE</b></p>
<p>BELLOWS 20-2</p> <p>CROSS SECTION</p> <p>BEAD PLATE TOP</p> <p>BEAD PLATE BOTTOM</p>	<p>AON <b>W01-358-6962</b></p> <p>8.41</p> <p><b>APPLICATIONS:</b> Hendrickson Trailer S21323</p> <p><b>OBSELETE: NO LONGER AVAILABLE</b></p>
<p>BELLOWS 21</p> <p>CROSS SECTION</p> <p>BEAD PLATE TOP</p> <p>BEAD PLATE BOTTOM</p>	<p>AON <b>W01-358-7123</b></p> <p>19.21</p> <p><b>APPLICATIONS:</b> Kwik Lok/Todco (Jifflox) 53671</p> <p><b>REPLACES W01-358-7133</b></p>

BELLOWS 21	AON W01-358-7135	17.50
	<p><b>APPLICATIONS:</b> Holland (Neway) 90557001 Pezzani AR-21-A Ridewell 1003587135C Silent Drive Truckstell (Marion Mfg.) 63641 Truckstell (Marion Mfg.) 63644 Hendrickson Can. B-12514-014</p>	

BELLOWS 21	AON W01-358-7136	22.09
	<p><b>APPLICATIONS:</b>  Fargo Trailer Granning 1626 Hendrickson Trailer S1080 R &amp; S Truck &amp; Body 1027556 Ridewell 1003587136C Watson &amp; Chalin AS-0004</p>	

BELLOWS 21	AON W01-358-7140	22.73
	<p><b>APPLICATIONS:</b> Granning 1015 Hendrickson Trailer S3184 Porcupine (replaces 7142) R &amp; S Truck &amp; Body 1090214 Ridewell 1003587140C Temisko Watson &amp; Chalin AS-0008</p>	

BELLOWS 21	AON W01-358-7145	17.23
	<p><b>APPLICATIONS:</b> Mack 57QL239 Ridewell 1003587145C Volvo/GM-Heavy Duty Truck 35203-0005</p>	

BELLOWS 21	AON W01-358-7146	20.44
	<p><b>APPLICATIONS:</b> American Carrier 8003-005 EZ Ride Holland (Neway) 90557039 Ridewell 1003587146C Willmar Gallenberg Mod. Flow Equip.</p>	

**HARDWARE KEY**

- Bolt or Stud 1/2-13
- ⊗ Air Inlet 1/4 N.P.T.
- ⊗ Combination Stud/Air Inlet Stud Outside Thread is 3/4-16 Pistons
- ⊗ Exception to Standard Stud/Air Inlet Stud Inside Thread of 1/4 N.P.T.
- ▲ No Alignment Specified-Center Stud Mounting is Standard
- ⊗ Threaded Hole 3/8-16 Blind Nut on Bead Plates 1/2-13 Pistons

BELLOWS 21	AON W01-358-8171	18.07
	<p><b>APPLICATIONS:</b> Arvin Meritor A-2258-A-1457 RPH-11</p>	

BELLOWS 21-2	AON W01-358-6800	17.56
	<p><b>APPLICATIONS:</b> Watson &amp; Chalin AS-0034 (see W01-358-6808)</p>	

BELLOWS 21-2	AON W01-358-6801	23.15
	<p><b>APPLICATIONS:</b> EZ Ride 8030160 Hendrickson Trailer S2734 Ridewell 1003586801C Watson &amp; Chalin AS-0021</p>	

BELLOWS 21-2	AON W01-358-6802	17.61
	<p><b>APPLICATIONS:</b></p>	

BELLOWS 21-2	AON W01-358-6803	21.37
	<p><b>APPLICATIONS:</b> Hendrickson Trailer S6412</p> <p style="color: red; font-weight: bold;">OBSOLETE: NO LONGER AVAILABLE</p>	

<p>BELLOWS 21-2</p> <p>CROSS SECTION BEAD PLATE TOP BEAD PLATE BOTTOM</p>	<p>AON W01-358-6805</p> <p>20.74</p> <p><b>APPLICATIONS:</b> Ridewell 1003586805C</p>
<p>BELLOWS 21-2</p> <p>CROSS SECTION BEAD PLATE TOP BEAD PLATE BOTTOM</p>	<p>AON W01-358-6808</p> <p>21.20</p> <p><b>APPLICATIONS:</b> Watson &amp; Chalin AS-0034 Holland (Neway) (replaced by 6799)</p>
<p>BELLOWS 21-2</p> <p>CROSS SECTION BEAD PLATE TOP BEAD PLATE BOTTOM</p>	<p>AON W01-358-9529</p> <p>17.57</p> <p><b>APPLICATIONS:</b></p>
<p>BELLOWS 22</p> <p>CROSS SECTION BEAD PLATE TOP BEAD PLATE BOTTOM</p>	<p>AON W01-358-7180</p> <p>12.00</p> <p><b>APPLICATIONS:</b> EZ Ride 8030190 Hendrickson Kwiklok/Todco (Jifflox) Peerless 0550-00001 Talbert Ridewell 1003587180C</p>
<p>BELLOWS 22</p> <p>CROSS SECTION BEAD PLATE TOP BEAD PLATE BOTTOM</p>	<p>AON W01-358-7181</p> <p>12.37</p> <p><b>APPLICATIONS:</b> Fruehauf UAB-5620 Fruehauf UCC-3054-1</p> <p><b>OBSELETE: NO LONGER AVAILABLE</b></p>

**HARDWARE KEY**

- Bolt or Stud 1/2-13
- ⊗ Air Inlet 1/4 N.P.T.
- ⊗ Combination Stud/Air Inlet Stud Outside Thread is 3/4-16 Pistons
- ⊗ Exception to Standard Stud/Air Inlet Stud Inside Thread of 1/4 N.P.T.

▲ No Alignment Specified-Center Stud Mounting is Standard  
⊗ Threaded Hole 3/8-16 Blind Nut on Bead Plates 1/2-13 Pistons

<p>BELLOWS 22</p> <p>CROSS SECTION BEAD PLATE TOP BEAD PLATE BOTTOM</p>	<p>AON W01-358-7183</p> <p>14.35</p> <p><b>APPLICATIONS:</b> Fruehauf UCA-0112 Fruehauf UCA-0112-B</p>
<p>BELLOWS 22</p> <p>CROSS SECTION BEAD PLATE TOP BEAD PLATE BOTTOM</p>	<p>AON W01-358-7185</p> <p>14.38</p> <p><b>APPLICATIONS:</b> Chalmers</p>
<p>BELLOWS 22</p> <p>CROSS SECTION BEAD PLATE TOP BEAD PLATE BOTTOM</p>	<p>AON W01-358-7344</p> <p>12.34</p> <p><b>APPLICATIONS:</b> Load Air P10-755C Sauer P10-755C</p>
<p>BELLOWS 22</p> <p>CROSS SECTION BEAD PLATE TOP BEAD PLATE BOTTOM</p>	<p>AON W01-358-7400</p> <p>13.89</p> <p><b>APPLICATIONS:</b> Fab Tek 04-0080 Freightliner 16-10769-000 GMC 693230 Granning 2726 Hendrickson Trailer S1013 Holland (Neway) 90557016 R &amp; S Truck &amp; Body 1027519 Ridewell 1003587400C</p>
<p>BELLOWS 22</p> <p>CROSS SECTION BEAD PLATE TOP BEAD PLATE BOTTOM</p>	<p>AON W01-358-7401</p> <p>15.86</p> <p><b>APPLICATIONS:</b> GMC 711954 GMC 2076095 Volvo/GM Heavy Duty Truck 2076095 Watson &amp; Chalin AS-0014</p>

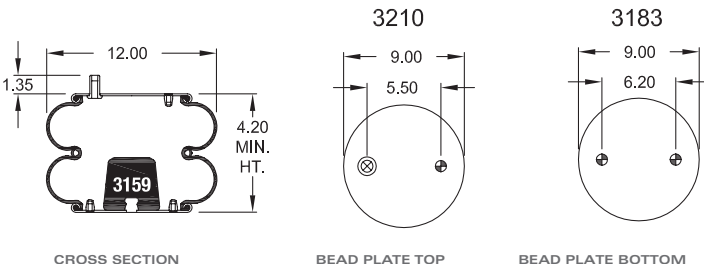
BELLOWS 22	AON W01-358-7403	14.38
	<p><b>APPLICATIONS:</b> Granning 2725 Hendrickson Trailer S1159 Hendrickson Trailer S2883 Hendrickson Can. B-12514-001 R &amp; S Truck &amp; Body 1040201 Ridewell 1003587403C Watson &amp; Chalin AS-0007</p>	

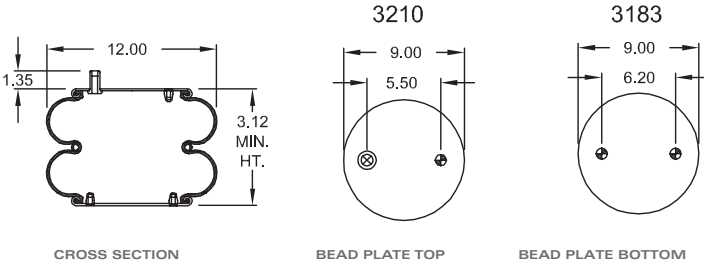
BELLOWS 22	AON W01-358-7404	12.33
	<p><b>APPLICATIONS:</b> Hendrickson Trailer S5488 Hendrickson Can. S1345 (replaced by 7472)</p>	

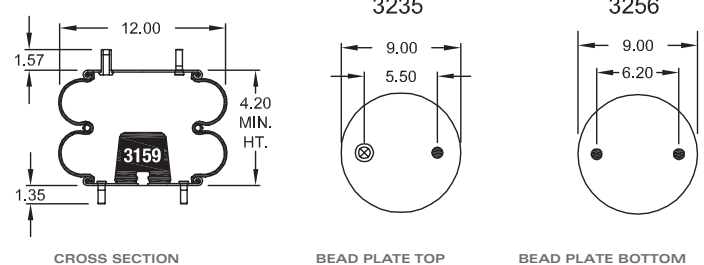
BELLOWS 22	AON W01-358-7405	14.34
	<p><b>APPLICATIONS:</b> Hutchens H-10384-01 Suspensions Inc.</p>	

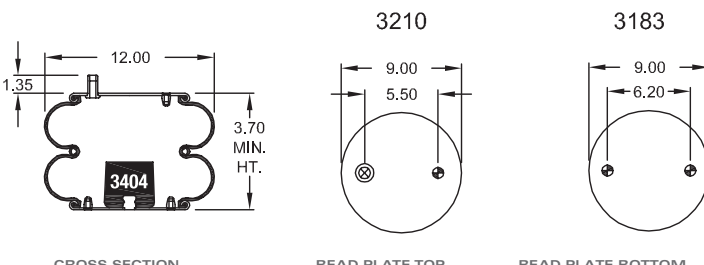
BELLOWS 22	AON W01-358-7408	14.22
	<p><b>APPLICATIONS:</b> EZ Ride</p> <p><b>OBSELETE: NO LONGER AVAILABLE</b></p>	

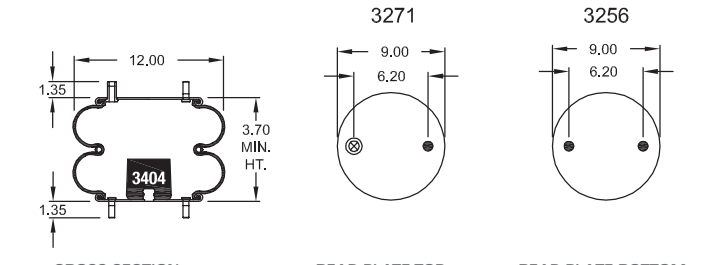
BELLOWS 22	AON W01-358-7409	14.27
	<p><b>APPLICATIONS:</b> Fruehauf</p>	

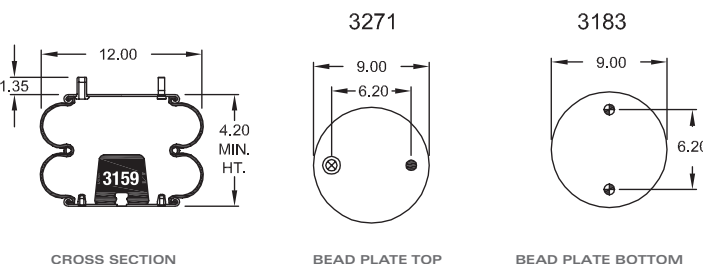
BELLOWS 22	AON W01-358-7410	13.94
	<p><b>APPLICATIONS:</b> Freightliner 16-11378-000</p>	

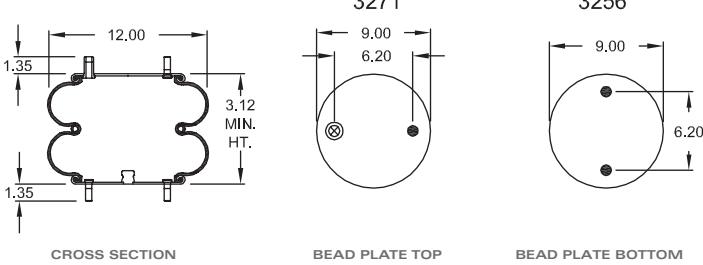
BELLOWS 22	AON W01-358-7423	12.46
	<p><b>APPLICATIONS:</b> Sauer P10-784</p>	

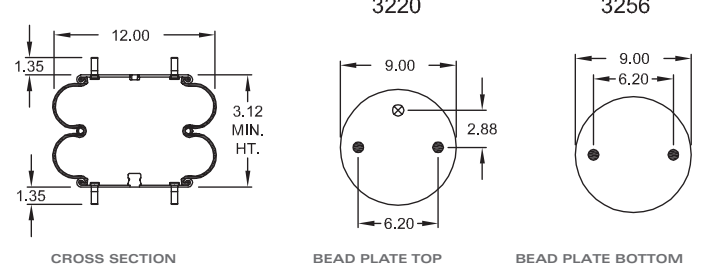
BELLOWS 22	AON W01-358-7424	12.51
	<p><b>APPLICATIONS:</b> Intergrated Holland (Neway) 90557014 (AL-41 &amp; 45) Porcupine R &amp; S Truck &amp; Body 1090215 Sauer P10-755</p>	

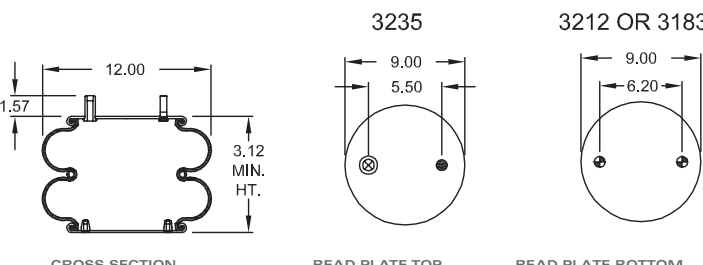
BELLOWS 22	AON W01-358-7429	12.50
	<p><b>APPLICATIONS:</b> Kwik Lok/Todco (Jifflox) CP-5223 Silent Drive</p>	

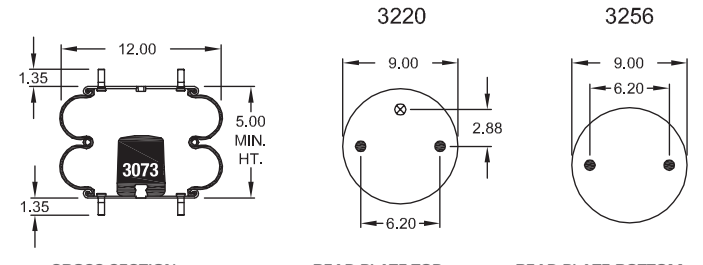
BELLOWS 22	AON W01-358-7437	14.82
	<p><b>APPLICATIONS:</b> Holland (Neway) 90557015 Ridewell 1003587437C</p>	

**HARDWARE KEY**

- Bolt or Stud 1/2-13
- ⊗ Air Inlet 1/4 N.P.T.
- ⊙ Combination Stud/Air Inlet Stud Outside Thread is 3/4-16 Pistons
- ⊕ Exception to Standard Stud/Air Inlet Stud Inside Thread of 1/4 N.P.T.
- ▲ No Alignment Specified-Center Stud Mounting is Standard
- ⊖ Threaded Hole 3/8-16 Blind Nut on Bead Plates 1/2-13 Pistons



BELLOWS 22-1.5		AON W01-358-7443		12.69
3208		3212 or 3183		<b>APPLICATIONS:</b> Granning 1218 (replaces 7416) Watson & Chalin AS-0027 (replaces 7416) Ridewell 1003587443C
CROSS SECTION	BEAD PLATE TOP	BEAD PLATE BOTTOM		
BELLOWS 22-1.5		AON W01-358-7444		12.71
3215		3212 or 3183		<b>APPLICATIONS:</b> Hendrickson Trailer S9830
CROSS SECTION	BEAD PLATE TOP	BEAD PLATE BOTTOM		
BELLOWS 22-1.5		AON W01-358-7446		14.43
3271		3183		<b>APPLICATIONS:</b> Hendrickson Trailer S3798 R & S Truck & Body 1082914 Watson & Chalin AS-0005
CROSS SECTION	BEAD PLATE TOP	BEAD PLATE BOTTOM		
BELLOWS 22-1.5		AON W01-358-7447		14.14
3210		3183		<b>APPLICATIONS:</b> EZ Ride 8030150 Hendrickson Trailer S6242 Silent Drive
CROSS SECTION	BEAD PLATE TOP	BEAD PLATE BOTTOM		
BELLOWS 22-1.5		AON W01-358-7473		14.42
3215		3183		<b>APPLICATIONS:</b> Ridewell 1003587473C
CROSS SECTION	BEAD PLATE TOP	BEAD PLATE BOTTOM		

**HARDWARE KEY**

- Bolt or Stud 1/2-13
- ⊗ Air Inlet 1/4 N.P.T.
- ⊗ Combination Stud/Air Inlet Stud Outside Thread is 3/4-16 Pistons
- ⊗ Exception to Standard Stud/Air Inlet Stud Inside Thread of 1/4 N.P.T.
- ▲ No Alignment Specified-Center Stud Mounting is Standard
- ⊗ Threaded Hole 3/8-16 Blind Nut on Bead Plates 1/2-13 Pistons

BELLOWS 22-1.5		AON W01-358-7790		14.33
3159		3003		<b>APPLICATIONS:</b> Hendrickson Aux. 001475
CROSS SECTION	BEAD PLATE TOP	BEAD PLATE BOTTOM		
BELLOWS 26		AON W01-358-7325		5.31
3450		3436		<b>APPLICATIONS:</b> American Carrier 8003-006 Mack 227QS-32 & 57QK1113 Sauer P10-754 Texas Truck Watson & Chalin AS-0030
CROSS SECTION	BEAD PLATE TOP	BEAD PLATE BOTTOM		
BELLOWS 26		AON W01-358-7330		5.37
3136		3371		<b>APPLICATIONS:</b> Ridewell 1003587330
CROSS SECTION	BEAD PLATE TOP	BEAD PLATE BOTTOM		
BELLOWS 26		AON W01-358-7339		4.77
3386		3071		<b>APPLICATIONS:</b>
CROSS SECTION	BEAD PLATE TOP	BEAD PLATE BOTTOM		
BELLOWS 26		AON W01-358-7504		5.33
3067		3436		<b>APPLICATIONS:</b>
CROSS SECTION	BEAD PLATE TOP	BEAD PLATE BOTTOM		

<p>BELLOWS 26</p> <p>CROSS SECTION BEAD PLATE TOP BEAD PLATE BOTTOM</p>	<p>AON W01-358-7505</p> <p>5.54</p> <p>APPLICATIONS: Hendrickson 001347</p>
<p>BELLOWS 26</p> <p>CROSS SECTION BEAD PLATE TOP BEAD PLATE BOTTOM</p>	<p>AON W01-358-7659</p> <p>5.03</p> <p>APPLICATIONS: Hendrickson 005079</p>
<p>BELLOWS 26</p> <p>CROSS SECTION BEAD PLATE TOP BEAD PLATE BOTTOM</p>	<p>AON W01-358-7705</p> <p>4.87</p> <p>APPLICATIONS: Watson Chalin AS-006 (Replaces 7503)</p>
<p>BELLOWS 28</p> <p>CROSS SECTION BEAD PLATE TOP BEAD PLATE BOTTOM</p>	<p>AON W01-358-7271</p> <p>31.67</p> <p>APPLICATIONS: Ridewell 1003587271C</p>
<p>BELLOWS 28</p> <p>CROSS SECTION BEAD PLATE TOP BEAD PLATE BOTTOM</p>	<p>AON W01-358-7512</p> <p>36.33</p> <p>APPLICATIONS: Wilmar Gallenberg</p>

**HARDWARE KEY**

- Bolt or Stud 1/2-13
- ⊗ Air Inlet 1/4 N.P.T.
- ⊗ Combination Stud/Air Inlet Stud Outside Thread is 3/4-16 Pistons
- ⊗ Exception to Standard Stud/Air Inlet Stud Inside Thread of 1/4 N.P.T.

▲ No Alignment Specified-Center Stud Mounting is Standard  
 ⊗ Threaded Hole 3/8-16 Blind Nut on Bead Plates 1/2-13 Pistons

<p>BELLOWS 29</p> <p>CROSS SECTION BEAD PLATE TOP BEAD PLATE BOTTOM</p>	<p>AON W01-358-7275</p> <p>53.18</p> <p>APPLICATIONS: Ridewell 1003587275C</p>
<p>BELLOWS 201</p> <p>CROSS SECTION BEAD PLATE TOP BEAD PLATE BOTTOM</p> <p>(Includes bolts, nuts, &amp; washers)</p>	<p>AON W01-358-7244</p> <p>19.87</p> <p>APPLICATIONS: Ridewell 1003587271C</p>
<p>BELLOWS 203</p> <p>CROSS SECTION BEAD PLATE TOP BEAD PLATE BOTTOM</p>	<p>AON W01-358-7273</p> <p>43.21</p> <p>APPLICATIONS: Ridewell 1003587273C Watson &amp; Chalin AS-0045</p>
<p>BELLOWS 205</p> <p>CROSS SECTION BEAD PLATE TOP BEAD PLATE BOTTOM</p>	<p>AON W01-358-7927</p> <p>22.25</p> <p>APPLICATIONS: Maurice Welding</p>
<p>BELLOWS 215</p> <p>CROSS SECTION BEAD PLATE TOP BEAD PLATE BOTTOM</p> <p>(Includes bolts, nuts, &amp; washers)</p>	<p>AON W01-358-7230</p> <p>41.02</p> <p>BEAD RING WC1-358-3499</p> <p>APPLICATIONS: Pollard Holland Hitch 6788</p>

<p>BELLOWS <b>224</b></p> <p>CROSS SECTION BEAD PLATE TOP BEAD PLATE BOTTOM</p>	<p>AON <b>W01-358-3400</b></p> <p>4.92</p> <p><b>APPLICATIONS:</b> American Carrier 8003-009</p>
<p>BELLOWS <b>224</b></p> <p>CROSS SECTION BEAD PLATE TOP BEAD PLATE BOTTOM</p>	<p>AON <b>W01-358-3402</b></p> <p>5.01</p> <p><b>APPLICATIONS:</b> American Carrier 8003-026 (supersedes 9455-Bellows 1T47A-1)</p> <p><b>REPLACES W01-358-3401 AND W01-358-3405</b></p>
<p>BELLOWS <b>224</b></p> <p>CROSS SECTION BEAD PLATE TOP BEAD PLATE BOTTOM</p>	<p>AON <b>W01-358-3406</b></p> <p>4.96</p> <p><b>APPLICATIONS:</b> Sauer P20-706</p> <p><b>OBSOLETE: NO LONGER AVAILABLE</b></p>
<p>BELLOWS <b>228-1.5</b></p> <p>CROSS SECTION BEAD PLATE TOP BEAD PLATE BOTTOM</p>	<p>AON <b>W01-358-7472</b></p> <p>14.10</p> <p><b>APPLICATIONS:</b> Hendrickson Can. B-12514-005</p>
<p>BELLOWS <b>228-1.5</b></p> <p>CROSS SECTION BEAD PLATE TOP BEAD PLATE BOTTOM</p>	<p>AON <b>W01-358-7545</b></p> <p>14.86</p> <p><b>APPLICATIONS:</b> Hendrickson Aux. 001796 (Paralift Ultra/ High Lift) -lift bag Watson &amp; Chalin AS-0087-1F</p>

**HARDWARE KEY**

- Bolt or Stud 1/2-13
- ⊗ Air Inlet 1/4 N.P.T.
- ⊗ Combination Stud/Air Inlet Stud Outside Thread is 3/4-16 Pistons
- ⊗ Exception to Standard Stud/Air Inlet Stud Inside Thread of 1/4 N.P.T.

▲ No Alignment Specified-Center Stud Mounting is Standard  
 ⊗ Threaded Hole 3/8-16 Blind Nut on Bead Plates 1/2-13 Pistons

<p>BELLOWS <b>228-1.5</b></p> <p>CROSS SECTION BEAD PLATE TOP BEAD PLATE BOTTOM</p>	<p>AON <b>W01-358-7550</b></p> <p>14.32</p> <p><b>APPLICATIONS:</b> Watson &amp; Chalin AS-0087 Histeer 10315</p>
<p>BELLOWS <b>228-1.5</b></p> <p>CROSS SECTION BEAD PLATE TOP BEAD PLATE BOTTOM</p>	<p>AON <b>W01-358-7555</b></p> <p>14.49</p> <p><b>APPLICATIONS:</b> Reyco 20018-01 (86AR) Binkley XB-SPN-053-37</p>
<p>BELLOWS <b>228-1.5</b></p> <p>CROSS SECTION BEAD PLATE TOP BEAD PLATE BOTTOM</p>	<p>AON <b>W01-358-7949</b></p> <p>14.84</p> <p><b>APPLICATIONS:</b></p>
<p>BELLOWS <b>233-2</b></p> <p>CROSS SECTION BEAD PLATE TOP BEAD PLATE BOTTOM</p>	<p>AON <b>W01-358-6799</b></p> <p>21.78</p> <p><b>APPLICATIONS:</b> Holland (Neway) 90557203</p>
<p>BELLOWS <b>233-2</b></p> <p>CROSS SECTION BEAD PLATE TOP BEAD PLATE BOTTOM</p>	<p>AON <b>W01-358-7557</b></p> <p>20.57</p> <p><b>APPLICATIONS:</b> Reyco 19983-01 (21AR, 74AR) Watson &amp; Chalin AS-0089 Histeer 10316</p>

<p>BELLOWS <b>233-2</b></p> <p>CROSS SECTION</p> <p>BEAD PLATE TOP</p> <p>BEAD PLATE BOTTOM</p>	<p>AON <b>W01-358-7781</b></p> <p>23.11</p> <p><b>APPLICATIONS:</b> Ridewell 1003587781C</p>
<p>BELLOWS <b>233-2</b></p> <p>CROSS SECTION</p> <p>BEAD PLATE TOP</p> <p>BEAD PLATE BOTTOM</p>	<p>AON <b>W01-358-7782</b></p> <p>22.06</p> <p><b>APPLICATIONS:</b> Porcupine (replaces 7140) Watson &amp; Chalin AS-0032 (replaces 7240)</p>
<p>BELLOWS <b>264</b></p> <p>CROSS SECTION</p> <p>BEAD PLATE TOP</p> <p>BEAD PLATE BOTTOM</p>	<p>AON <b>W01-358-3420</b></p> <p>5.34</p> <p><b>APPLICATIONS:</b> Hendrickson Aux. 004647</p>
<p>BELLOWS <b>267-1.5</b></p> <p>CROSS SECTION</p> <p>BEAD PLATE TOP</p> <p>BEAD PLATE BOTTOM</p>	<p>AON <b>W01-358-6215</b></p> <p>3.35</p> <p><b>APPLICATIONS:</b></p>
<p>BELLOWS <b>267-1.5</b></p> <p>CROSS SECTION</p> <p>BEAD PLATE TOP</p> <p>BEAD PLATE BOTTOM</p>	<p>AON <b>W01-358-6831</b></p> <p>3.34</p> <p>TANK VALVE <b>WC1-358-0009</b></p> <p><b>APPLICATIONS:</b> John Deere AW30683</p>

**HARDWARE KEY**

- Bolt or Stud 1/2-13
- ⊗ Air Inlet 1/4 N.P.T.
- ⊗ Combination Stud/Air Inlet Stud Outside Thread is 3/4-16 Pistons
- ⊗ Exception to Standard Stud/Air Inlet Stud Inside Thread of 1/4 N.P.T.

▲ No Alignment Specified-Center Stud Mounting is Standard  
 ⊗ Threaded Hole 3/8-16 Blind Nut on Bead Plates 1/2-13 Pistons

<p>BELLOWS <b>268</b></p> <p>CROSS SECTION</p> <p>BEAD PLATE TOP</p> <p>BEAD PLATE BOTTOM</p>	<p>AON <b>W01-358-7025</b></p> <p>3.23</p> <p><b>APPLICATIONS:</b> WESTERN STAR (Cab Spring)</p>
<p>BELLOWS <b>268</b></p> <p>CROSS SECTION</p> <p>BEAD PLATE TOP</p> <p>BEAD PLATE BOTTOM</p>	<p>AON <b>W01-358-7057</b></p> <p>3.37</p> <p><b>APPLICATIONS:</b> Sauer P10-794</p> <p><b>OBSELETE: NO LONGER AVAILABLE</b></p>
<p>BELLOWS <b>38</b></p> <p>CROSS SECTION</p> <p>BEAD PLATE TOP</p> <p>BEAD PLATE BOTTOM</p>	<p>AON <b>W01-358-7990</b></p> <p>16.03</p> <p><b>APPLICATIONS:</b> Watson &amp; Chalin AS-0048</p>
<p>BELLOWS <b>38</b></p> <p>CROSS SECTION</p> <p>BEAD PLATE TOP</p> <p>BEAD PLATE BOTTOM</p>	<p>AON <b>W01-358-7994</b></p> <p>16.44</p> <p><b>APPLICATIONS:</b> Watson &amp; Chalin AS-0019-1F (ref. W01-358-8008)</p>
<p>BELLOWS <b>38</b></p> <p>CROSS SECTION</p> <p>BEAD PLATE TOP</p> <p>BEAD PLATE BOTTOM</p>	<p>AON <b>W01-358-7995</b></p> <p>17.49</p> <p><b>APPLICATIONS:</b> Watson &amp; Chalin AS-0048-1F (ref. W01-358-8032)</p>

<p>BELLOWS 38</p> <p>CROSS SECTION</p> <p>BEAD PLATE TOP</p> <p>BEAD PLATE BOTTOM</p>	<p>AON <b>W01-358-7996</b></p> <p>15.92</p> <p><b>APPLICATIONS:</b> Granning 8221</p>
<p>BELLOWS 38</p> <p>CROSS SECTION</p> <p>BEAD PLATE TOP</p> <p>BEAD PLATE BOTTOM</p>	<p>AON <b>W01-358-8006</b></p> <p>14.46</p> <p><b>APPLICATIONS:</b> Superior</p>
<p>BELLOWS 38</p> <p>CROSS SECTION</p> <p>BEAD PLATE TOP</p> <p>BEAD PLATE BOTTOM</p>	<p>AON <b>W01-358-8008</b></p> <p>17.67</p> <p><b>APPLICATIONS:</b> EZ Ride Histeer Ridewell 1003588008C Silent Drive Watson &amp; Chalin AS-0019 Hendrickson Trailer S11637</p>
<p>BELLOWS 38</p> <p>CROSS SECTION</p> <p>BEAD PLATE TOP</p> <p>BEAD PLATE BOTTOM</p>	<p>AON <b>W01-358-8010</b></p> <p>17.71</p> <p><b>APPLICATIONS:</b> Ridewell 1003588010C Tafco Oshkosh (ref.8013)</p>
<p>BELLOWS 38</p> <p>CROSS SECTION</p> <p>BEAD PLATE TOP</p> <p>BEAD PLATE BOTTOM</p>	<p>AON <b>W01-358-8014</b></p> <p>16.62</p> <p><b>APPLICATIONS:</b> Ridewell 1003588014C</p> <p><b>OBSELETE: NO LONGER AVAILABLE</b></p>

**HARDWARE KEY**

- Bolt or Stud 1/2-13
- ⊗ Air Inlet 1/4 N.P.T.
- ⊗ Combination Stud/Air Inlet Stud Outside Thread is 3/4-16 Pistons
- ⊗ Exception to Standard Stud/Air Inlet Stud Inside Thread of 1/4 N.P.T.

- ▲ No Alignment Specified-Center Stud Mounting is Standard
- ⊗ Threaded Hole 3/8-16 Blind Nut on Bead Plates 1/2-13 Pistons

<p>BELLOWS 38</p> <p>CROSS SECTION</p> <p>BEAD PLATE TOP</p> <p>BEAD PLATE BOTTOM</p>	<p>AON <b>W01-358-8016</b></p> <p>13.98</p> <p><b>APPLICATIONS:</b> Ridewell 1003588016C</p>
<p>BELLOWS 38</p> <p>CROSS SECTION</p> <p>BEAD PLATE TOP</p> <p>BEAD PLATE BOTTOM</p>	<p>AON <b>W01-358-8018</b></p> <p>17.28</p> <p><b>APPLICATIONS:</b> Histeer Reyco 93AR Suspensions Inc. Watson &amp; Chalin</p>
<p>BELLOWS 38</p> <p>CROSS SECTION</p> <p>BEAD PLATE TOP</p> <p>BEAD PLATE BOTTOM</p>	<p>AON <b>W01-358-8025</b></p> <p>17.34</p> <p><b>APPLICATIONS:</b> Silent Drive Van Raden</p> <p><b>REPLACES W01-358-8028</b></p>
<p>BELLOWS 38</p> <p>CROSS SECTION</p> <p>BEAD PLATE TOP</p> <p>BEAD PLATE BOTTOM</p>	<p>AON <b>W01-358-8027</b></p> <p>16.50</p> <p><b>APPLICATIONS:</b> Suspensions Inc. 200117 Histeer (supersedes 8029) Silent Drive</p>
<p>BELLOWS 38</p> <p>CROSS SECTION</p> <p>BEAD PLATE TOP</p> <p>BEAD PLATE BOTTOM</p>	<p>AON <b>W01-358-8030</b></p> <p>18.33</p> <p><b>APPLICATIONS:</b> Ridewell 1003588030C</p>

BELLOWS 38	AON W01-358-8032	18.09
	<p><b>APPLICATIONS:</b> Hendrickson Trailer S12405</p>	

BELLOWS 38	AON W01-358-8033	16.78
	<p><b>APPLICATIONS:</b> Hendrickson Trailer S14487 (Ride Bag) [Paralift Ultra] [Pararev] Hendrickson Aux. 003316 (metric version)</p>	

BELLOWS 39	AON W01-358-7852	28.58
	<p><b>APPLICATIONS:</b> Porcupine Maurice Welding</p>	

BELLOWS 312	AON W01-358-7286	38.18
	<p><b>APPLICATIONS:</b> Ridewell 1003587286C Superior</p>	

BELLOWS 312	AON W01-358-7761	24.60
	<p><b>APPLICATIONS:</b> Superior</p>	

**HARDWARE KEY**

- Bolt or Stud 1/2-13
- ⊗ Air Inlet 1/4 N.P.T.
- ⊗ Combination Stud/Air Inlet Stud Outside Thread is 3/4-16 Pistons
- ⊗ Exception to Standard Stud/Air Inlet Stud Inside Thread of 1/4 N.P.T.
- ▲ No Alignment Specified-Center Stud Mounting is Standard
- ⊗ Threaded Hole 3/8-16 Blind Nut on Bead Plates 1/2-13 Pistons

BELLOWS 312	AON W01-358-7915	15.77
	<p><b>APPLICATIONS:</b> Superior</p>	

BELLOWS 313	AON W01-358-7796	25.24
	<p><b>APPLICATIONS:</b> Ridewell 1003587796C</p>	<p><b>OBSELETE: NO LONGER AVAILABLE</b></p>

BELLOWS 313	AON W01-358-7797	21.01
	<p><b>APPLICATIONS:</b> Hendrickson Aux. 001346</p>	

BELLOWS 313	AON W01-358-7798	23.90
	<p><b>APPLICATIONS:</b> Allison Granning 1613 R &amp; S Truck &amp; Body Watson &amp; Chalin AS-0006</p>	

BELLOWS 313	AON W01-358-7800	23.97
	<p><b>APPLICATIONS:</b> Granning 4514 Holland Hitch 4514 Ridewell 1003587800C Silent Drive</p>	

BELLOWS 313	AON W01-358-7808	20.64
	<p><b>3131 or 3134</b></p> <p><b>3130</b></p>	<p><b>APPLICATIONS:</b> Ridewell 1003587808C Truckstell (Marion Mfg.) 63640 EZ Ride 8030170</p>

BELLOWS 313	AON W01-358-7818	23.70
	<p><b>3132</b></p> <p><b>3122</b></p>	<p><b>APPLICATIONS:</b> EZ Ride 8030180 Granning 1014 Ridewell 1003587818C Superior Watson &amp; Chalin AS-0025</p>

BELLOWS 320	AON W01-358-7276	64.94
	<p><b>3473</b></p> <p><b>3474</b></p>	<p><b>APPLICATIONS:</b> Wabash</p>

BELLOWS 321	AON W01-358-7304	54.50
	<p><b>4311</b></p> <p><b>4311</b></p>	<p><b>APPLICATIONS:</b> Ottawa 53500516 Pollard Holland Hitch 6764</p> <p><b>REPLACES W01-358-7320</b></p>

BELLOWS 323	AON W01-358-7274	54.22
	<p><b>3475</b></p> <p><b>3476</b></p>	<p><b>APPLICATIONS:</b> Ridewell 1003587274C</p>

**HARDWARE KEY**

- Bolt or Stud 1/2-13
- ⊗ Air Inlet 1/4 N.P.T.
- ⊙ Combination Stud/Air Inlet Stud Outside Thread is 3/4-16 Pistons
- ⊕ Exception to Standard Stud/Air Inlet Stud Inside Thread of 1/4 N.P.T.
- ▲ No Alignment Specified-Center Stud Mounting is Standard
- ⊖ Threaded Hole 3/8-16 Blind Nut on Bead Plates 1/2-13 Pistons

BELLOWS 333	AON W01-358-7839	28.49
	<p><b>3111</b></p> <p><b>3316</b></p>	<p><b>APPLICATIONS:</b> Hendrickson Trailer S6861 Histeer 10300 Porcupine (replaces 7818) Ridewell Watson &amp; Chalin AS-0033 Silent Drive Superior</p>

BELLOWS 333	AON W01-358-7843	28.78
	<p><b>3193</b></p> <p><b>3122</b></p>	<p><b>APPLICATIONS:</b> Hendrickson Trailer S7100</p>

BELLOWS 333	AON W01-358-7845	24.38
	<p><b>3134</b></p> <p><b>3130</b></p>	<p><b>APPLICATIONS:</b> EZ Ride</p>

BELLOWS 333	AON W01-358-7846	28.40
	<p><b>3193</b></p> <p><b>3122</b></p>	<p><b>APPLICATIONS:</b> Hendrickson Trailer S7853</p>

BELLOWS 333	AON W01-358-7847	29.64
	<p><b>3193</b></p> <p><b>3149</b></p>	<p><b>APPLICATIONS:</b> Hendrickson Trailer S8874</p>

BELLOWS 333	AON W01-358-7848	24.68
	<p><b>APPLICATIONS:</b> Superior Suspensions Inc.</p>	

BELLOWS 333	AON W01-358-7850	28.03
	<p><b>APPLICATIONS:</b> Histeer 10301 Suspensions Inc. 200177 Watson &amp; Chalin AS-0086 (Replaces 7851 - adapter plates might be required)</p> <p><b>REPLACES W01-358-7837</b></p>	

BELLOWS 333	AON W01-358-7862	25.24
	<p><b>APPLICATIONS:</b> Hendrickson Aux. 001795 (Paralift Ultra/ High Lift) -ride bag</p>	

BELLOWS 333	AON W01-358-7872	25.17
	<p><b>APPLICATIONS:</b> Hendrickson Aux. 004828</p>	

BELLOWS 352	AON W01-358-7954	20.26
	<p><b>APPLICATIONS:</b> Hendrickson Aux. 002348</p> <p><b>OBSOLETE: NO LONGER AVAILABLE</b></p>	

BELLOWS 352	AON W01-358-7956	19.13
	<p><b>APPLICATIONS:</b> Rowe Truck 0059 ASC 1500</p>	

BELLOWS 352	AON W01-358-8042	19.85
	<p><b>APPLICATIONS:</b> Hendrickson Aux. 001015 Holland (Neway) 90557236 V-Steer II (Ride Bag)</p>	

BELLOWS 352	AON W01-358-8043	20.11
	<p><b>APPLICATIONS:</b> Hendrickson Trailer S14795</p>	

BELLOWS 354	AON W01-358-8038	18.10
	<p><b>APPLICATIONS:</b> Silent Drive Longer Stroke 8008 Histeer 10313</p>	

BELLOWS 354	AON W01-358-8039	16.71
	<p><b>APPLICATIONS:</b> Histeer 10303 (Longer Stroke 8018)</p>	

**HARDWARE KEY**

- Bolt or Stud 1/2-13
- ⊗ Air Inlet 1/4 N.P.T.
- ⊙ Combination Stud/Air Inlet Stud Outside Thread is 3/4-16 Pistons
- ⊕ Exception to Standard Stud/Air Inlet Stud Inside Thread of 1/4 N.P.T.
- ▲ No Alignment Specified-Center Stud Mounting is Standard
- ⊖ Threaded Hole 3/8-16 Blind Nut on Bead Plates 1/2-13 Pistons





Sleeve style air springs are used for cab and seating applications, creating a smooth, comfortable ride.

READING THE PARTS TABLE

<p>1 LOGO ORANGE</p>	<p>2 AON W02-358-7058</p>	<p>7 1.30    8 Composite</p>
	<p>4 CAP ID NO. NBD-10409 (7042)</p> <p>5 PISTON ID NO. NBD-12708 (6896)</p> <p>6 BCR <math>\updownarrow</math> 9.00</p>	<p>9 APPLICATIONS: NATIONAL SEATING 324662-01 (W02-N19-7058)</p> <p>10 OBSOLETE</p>

- 1. Logo Color**  
The Airide spring shield color indicates a very specific construction of the bellows, which helps with the identification process of the air spring.
- 2. Assembly Order Number (AON)**  
This number identifies the specific Firestone assembly order number that needs to be used for ordering purposes. It is important that the complete order number is used to avoid any confusion, especially with any type of electronic ordering. The complete order number in this example is W02-358-7058.
- 3. Cross Section View**  
Includes dimensional information in inches for uninflated diameter, maximum height, and collapsed height, as well as component dimensions.
- 4. Cap Identification Number**  
The drawing number is molded into most caps, followed by a 4 digit number in parentheses identifying the internal cap component number. Do not confuse this code with the AON.

- 5. Piston Identification Number**  
The piston identification number is molded into most pistons, followed by a 4 digit number in parentheses identifying the internal piston component number. Do not confuse this code with the AON.
- 6. BCR**  
This dimension is the measurement taken between the two metal rings on each end of the assembly. Note: BCR measurement will be somewhat shorter than specified in this guide.
- 7. Weight**  
The total weight of the spring assembly.
- 8. Piston Material**  
Aluminum, Steel, or Composite.
- 9. Applications**  
Includes all the information that is known about this specific application (i.e., model number, years of manufacture, part numbers, Firestone reference numbers, and competitor numbers, if known).
- 10. Assembly Notes**  
Important information if an assembly has been obsoleted and if there is an exact replacement part available, or if it has replaced other parts.

AIR SPRING IDENTIFICATION

Assembly Order Number (AON) 2

The quickest way to identify the air spring is to read the manufacturer or Firestone assembly order number (AON) on the label adhered to the cap. The complete order number must include the W02 number at the beginning. Use the following pages to find the correct number for your air spring. The complete AON in the diagram is W02-358-7058.

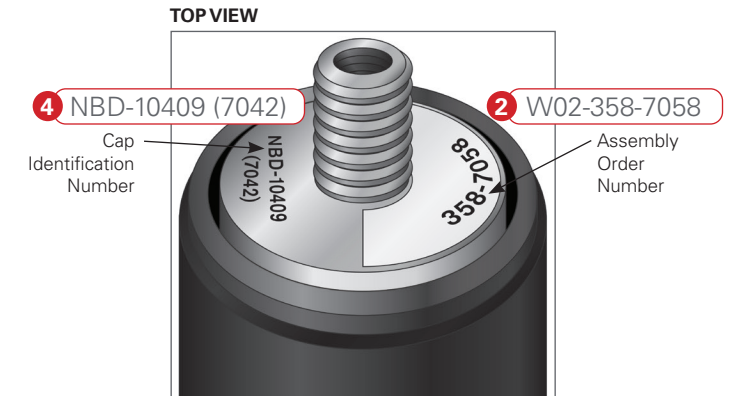

Logo Color 1

The parts tables are sorted by the air spring logo color. If the AON number is not legible, identify the Airide spring shield color to narrow down your search. From there, follow the steps below to identify your air spring.

Cap Identification Number 4

The cap can be used for further part identification in the parts diagrams by matching the drawing number (e.g. NBD-10409) or the cap component number (7042). In addition, the crimp (metal) ring around the cap has a code stamped into it. The last 4 digits of the seven-number string at the beginning of the code reference the cap identification number.

Piston Identification Number 5

The piston drawing (NBD-12708) or internal piston component number (6896) molded into the piston can also be used to narrow down the search for the correct replacement part.

BCR 6

If an additional identifier is needed, measure the distance between the two metal rings – one holding the cap in place and the other holding the bellows on the piston. This measurement is called the BCR, and is identified in the parts diagrams.

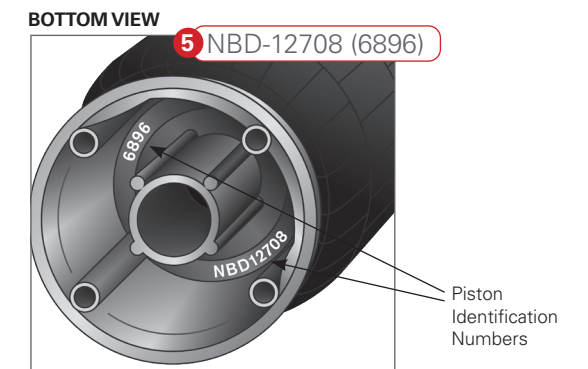
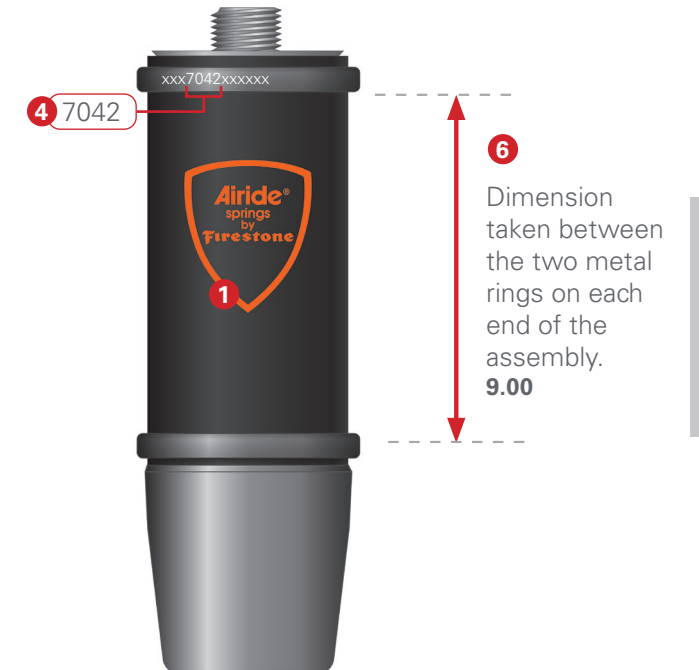

LOGO <b>ORANGE</b>	AON <b>W02-358-7018</b>	1.02 Aluminum
	<p><b>CAP ID NO.</b> NBD-10183 (7013)</p> <p><b>PISTON ID NO.</b> NBD-10795 (7054)</p> <p>BCR <math>\updownarrow</math> 5.00</p>	<p><b>APPLICATIONS:</b></p>

LOGO <b>ORANGE</b>	AON <b>W02-358-7086</b>	0.61 Composite
	<p><b>CAP ID NO.</b> NBD-10218 (7018)</p> <p><b>PISTON ID NO.</b> NBD-16538 (6913)</p> <p>BCR <math>\updownarrow</math> 5.25</p>	<p><b>APPLICATIONS:</b> LINK MANUFACTURING LTD 1102-0025 (FORD)</p>

LOGO <b>ORANGE</b>	AON <b>W02-358-7046</b>	0.70 Composite
	<p><b>CAP ID NO.</b> NBD-10470 (7068)</p> <p><b>PISTON ID NO.</b> NBD-16537 (6912)</p> <p>BCR <math>\updownarrow</math> 6.00</p>	<p><b>APPLICATIONS:</b> LINK MANUFACTURING LTD 1102-0022 (FORD, FRT, GMC, PETE)</p>

LOGO <b>ORANGE</b>	AON <b>W02-358-7079</b>	0.65 Composite
	<p><b>CAP ID NO.</b> NBD-11636 (7074)</p> <p><b>PISTON ID NO.</b> NBD-16537 (6912)</p> <p>BCR <math>\updownarrow</math> 6.00</p>	<p><b>APPLICATIONS:</b> LINK MANUFACTURING LTD 1102-0026 (NAV.)</p>

LOGO <b>ORANGE</b>	AON <b>W02-358-7001</b>	0.69 Composite
	<p><b>CAP ID NO.</b> NBD-10218 (7018)</p> <p><b>PISTON ID NO.</b> NBD-16538 (6913)</p> <p>BCR <math>\updownarrow</math> 6.25</p>	<p><b>APPLICATIONS:</b> LINK MANUFACTURING LTD 1102-0020 (NAV.) SEE 1102-0023 1102-0023 (FORD, FRT, GMC, KW, NAV., VOLVO) COMFORT RIDE WISE KENWORTH T81-1001</p>

LOGO <b>ORANGE</b>	AON <b>W02-358-7002</b>	1.04 Aluminum
	<p><b>CAP ID NO.</b> NBD-10082 (7014)</p> <p><b>PISTON ID NO.</b> NBD-10549 (7049)</p> <p>BCR <math>\updownarrow</math> 6.75</p>	<p><b>APPLICATIONS:</b></p>

LOGO <b>ORANGE</b>	AON <b>W02-358-7150</b>	0.68 Composite
	<p><b>CAP ID NO.</b> NBD-10239 (7015)</p> <p><b>PISTON ID NO.</b> NBD-16537 (6912)</p> <p>BCR <math>\updownarrow</math> 7.00</p>	<p><b>APPLICATIONS:</b> SEARS / DURAFORM S13384 (W02-811-7150)</p>

LOGO <b>ORANGE</b>	AON <b>W02-358-7201</b>	0.89 Composite
	<p><b>CAP ID NO.</b> NBD-10218 (7018)</p> <p><b>PISTON ID NO.</b> NBD-16538 (6913)</p> <p>BCR <math>\updownarrow</math> 7.25</p>	<p><b>APPLICATIONS:</b> FREIGHTLINER / STERLING 18-45068-000 STERLING DAY CAB OLD FORD # P/N F6HT5C06CAB HN-80 DAY CAB (1996 &amp; LATER)</p>

LOGO <b>ORANGE</b>	AON <b>W02-358-7100</b>	0.71 Composite
	<p><b>APPLICATIONS:</b> 3-TS W02-T03-7100</p> <p><b>CAP ID NO.</b> NBD-10470 (7068)</p> <p><b>PISTON ID NO.</b> NBD-16537 (6912)</p> <p>BCR <math>\updownarrow</math> 7.50</p>	

LOGO <b>ORANGE</b>	AON <b>W02-358-7132</b>	0.76 Composite
	<p><b>APPLICATIONS:</b> PETERBILT R81-6003</p> <p><b>CAP ID NO.</b> NBD-10218 (7018)</p> <p><b>PISTON ID NO.</b> NBD-16510 (6908)</p> <p>BCR <math>\updownarrow</math> 7.50</p>	

LOGO <b>ORANGE</b>	AON <b>W02-358-7041</b>	0.90 Composite
	<p><b>APPLICATIONS:</b> SEARS / DURAFORM S8645 (W02-811-7041)</p> <p><b>CAP ID NO.</b> NBD-10239 (7015)</p> <p><b>PISTON ID NO.</b> FIP-102217 (9636)</p> <p>BCR <math>\updownarrow</math> 8.25</p>	

LOGO <b>ORANGE</b>	AON <b>W02-358-7059</b>	0.90 Composite
	<p><b>APPLICATIONS:</b> NATIONAL SEATING 324663-01 (W02-N19-7059) 328035-01 (W02-N19-7069) 329666-01 (W02-N19-7084)</p> <p><b>CAP ID NO.</b> NBD-10409 (7042)</p> <p><b>PISTON ID NO.</b> NBD-12708 (6896)</p> <p>BCR <math>\updownarrow</math> 8.25</p>	

LOGO <b>ORANGE</b>	AON <b>W02-358-7058</b>	0.94 Composite
	<p><b>APPLICATIONS:</b> NATIONAL SEATING 324662-01 (W02-N19-7058)</p> <p><b>CAP ID NO.</b> NBD-10409 (7042)</p> <p><b>PISTON ID NO.</b> NBD-12708 (6896)</p> <p>BCR <math>\updownarrow</math> 9.00</p>	

LOGO <b>ORANGE</b>	AON <b>W02-358-7054</b>	0.90 Composite
	<p><b>APPLICATIONS:</b> WISE</p> <p><b>CAP ID NO.</b> NBD-10218 (7018)</p> <p><b>PISTON ID NO.</b> FIP-102216 (9638)</p> <p>BCR <math>\updownarrow</math> 9.25</p>	

LOGO <b>ORANGE</b>	AON <b>W02-358-7098</b>	0.90 Composite
	<p><b>APPLICATIONS:</b> LINK MANUFACTURING LTD 1102-0027</p> <p><b>CAP ID NO.</b> NBD-13262 (6997)</p> <p><b>PISTON ID NO.</b> FIP-102216 (9638)</p> <p>BCR <math>\updownarrow</math> 9.62</p> <p><b>OBsolete:</b> NO LONGER AVAILABLE</p>	

LOGO <b>ORANGE</b>	AON <b>W02-358-7010</b>	1.44 Aluminum
	<p><b>APPLICATIONS:</b></p> <p><b>CAP ID NO.</b> NBD-10010 (7007)</p> <p><b>PISTON ID NO.</b> NBD-10071 (7023)</p> <p>BCR <math>\updownarrow</math> 10.00</p>	

LOGO <b>ORANGE</b>	AON <b>W02-358-7040</b>	1.06 Composite
	<p><b>CAP ID NO.</b> NBD-10239 (7015)</p> <p><b>PISTON ID NO.</b> FIP-102217 (9636)</p> <p>BCR <math>\updownarrow</math> 10.00</p>	<p><b>APPLICATIONS:</b> KNOEDLER 7010 AL (USE 7040) (W02-K50-7060) SEARS / DURAFORM S5388 SEATS 707338 AIR FLEX</p>

LOGO <b>ORANGE</b>	AON <b>W02-358-7049</b>	0.98 Composite
	<p><b>CAP ID NO.</b> NBD-10470 (7068)</p> <p><b>PISTON ID NO.</b> FIP-102217 (9636)</p> <p>BCR <math>\updownarrow</math> 10.00</p>	<p><b>APPLICATIONS:</b> 3-TS W02-T03-7049</p> <p><b>OBSOLETE: NO LONGER AVAILABLE</b></p>

LOGO <b>ORANGE</b>	AON <b>W02-358-7055</b>	0.94 Composite
	<p><b>CAP ID NO.</b> NBD-10409 (7042)</p> <p><b>PISTON ID NO.</b> FIP-102215 (9637)</p> <p>BCR <math>\updownarrow</math> 10.00</p>	<p><b>APPLICATIONS:</b> NATIONAL SEATING 2112283 7050 PLASTIC (USE 7055)</p>

LOGO <b>ORANGE</b>	AON <b>W02-358-7149</b>	0.97 Composite
	<p><b>CAP ID NO.</b> NBD-10470 (7068)</p> <p><b>PISTON ID NO.</b> NBD-12708 (6896)</p> <p>BCR <math>\updownarrow</math> 10.00</p>	<p><b>APPLICATIONS:</b> 3-TS W02-T03-7149</p>

LOGO <b>ORANGE</b>	AON <b>W02-358-7073</b>	1.50 Aluminum
	<p><b>CAP ID NO.</b> NBD-10183 (7013)</p> <p><b>PISTON ID NO.</b> NBD-10071 (7023)</p> <p>BCR <math>\updownarrow</math> 11.00</p>	<p><b>APPLICATIONS:</b> CARE CONCEPT</p> <p><b>OBSOLETE: NO LONGER AVAILABLE</b></p>

LOGO <b>GREEN</b>	AON <b>W02-358-7031</b>	1.06 Aluminum
	<p><b>CAP ID NO.</b> NBD-10082 (7014)</p> <p><b>PISTON ID NO.</b> NBD-10549 (7049)</p> <p>BCR <math>\updownarrow</math> 7.00</p>	<p><b>APPLICATIONS:</b> MACK 227QS33 GY 1S4-007</p>

LOGO <b>GREEN</b>	AON <b>W02-358-7209</b>	0.70 Composite
	<p><b>CAP ID NO.</b> NBD-10409 (7042)</p> <p><b>PISTON ID NO.</b> FIP-100105 (6979)</p> <p>BCR <math>\updownarrow</math> 7.00</p>	<p><b>APPLICATIONS:</b> SEATS 708220 NBD-10409 FIP-100105 (W02-812-7209)</p> <p><b>OBSOLETE: NO LONGER AVAILABLE</b></p>

LOGO <b>GREEN</b>	AON <b>W02-358-7106</b>	0.90 Composite
	<p><b>CAP ID NO.</b> NBD-13262 (6997)</p> <p><b>PISTON ID NO.</b> FIP-102215 (9637)</p> <p>BCR <math>\updownarrow</math> 9.87</p>	<p><b>APPLICATIONS:</b> LINK MANUFACTURING LTD 1102-0030 (PETE.)</p>

LOGO GREEN	AON <b>W02-358-7085</b>	1.51 Aluminum
	<p><b>APPLICATIONS:</b> AIR FLEX (W02-A05-7085)</p> <p><b>CAP ID NO.</b> NBD-10183 (7013)</p> <p><b>PISTON ID NO.</b> NBD-10071 (7023)</p> <p>BCR <math>\updownarrow</math> 11.50</p>	

LOGO RED	AON <b>W02-358-7007</b>	1.06 Aluminum
	<p><b>APPLICATIONS:</b> MACK 227QS34 GY 1S6-067</p> <p><b>CAP ID NO.</b> NBD-9930 (7005)</p> <p><b>PISTON ID NO.</b> NBD-10549 (7049)</p> <p>BCR <math>\updownarrow</math> 6.25</p>	

LOGO RED	AON <b>W02-358-7204</b>	2.08 Composite
	<p><b>APPLICATIONS:</b> FREIGHTLINER / STERLING STERLING ACTERA 18-43472-000</p> <p><b>CAP ID NO.</b> NBD-13706 (6990)</p> <p><b>PISTON ID NO.</b> NBD-16538 (6913)</p> <p>BCR <math>\updownarrow</math> 8.00</p> <p><b>OBSELETE: NO LONGER AVAILABLE</b></p>	

LOGO RED	AON <b>W02-358-7080</b>	0.90 Composite
	<p><b>APPLICATIONS:</b> LINK MANUFACTURING LTD 1102-0031 (FRT.)</p> <p><b>CAP ID NO.</b> NBD-10239 (7015)</p> <p><b>PISTON ID NO.</b> FIP-102217 (9636)</p> <p>BCR <math>\updownarrow</math> 10.00</p>	

LOGO PINK	AON <b>W02-358-7070</b>	0.69 Composite
	<p><b>APPLICATIONS:</b> NATIONAL SEATING 2123403 (W02-N19-7070) W02-N19-7160</p> <p><b>CAP ID NO.</b> NBD-10409 (7042)</p> <p><b>PISTON ID NO.</b> NBD-16536 (6911)</p> <p>BCR <math>\updownarrow</math> 7.50</p>	

LOGO PINK	AON <b>W02-358-7115</b>	0.70 Composite
	<p><b>APPLICATIONS:</b></p> <p><b>CAP ID NO.</b> NBD-10604 (7050)</p> <p><b>PISTON ID NO.</b> NBD-16537 (6912)</p> <p>BCR <math>\updownarrow</math> 7.50</p>	

LOGO PINK	AON <b>W02-358-7116</b>	0.95 Composite
	<p><b>APPLICATIONS:</b> LINK MANUFACTURING 1101-0030</p> <p><b>CAP ID NO.</b> NBD-10604 (7050)</p> <p><b>PISTON ID NO.</b> FIP-102217 (9636)</p> <p>BCR <math>\updownarrow</math> 11.38</p>	

LOGO WHITE	AON <b>W02-358-7025</b>	1.08 Aluminum
	<p><b>APPLICATIONS:</b> FREIGHTLINER / WESTERN STAR (STYLE #25 BELLOWS)</p> <p><b>CAP ID NO.</b> NBD-10183 (7013)</p> <p><b>PISTON ID NO.</b> NBD-10795 (7054)</p> <p>BCR <math>\updownarrow</math> 6.50</p>	

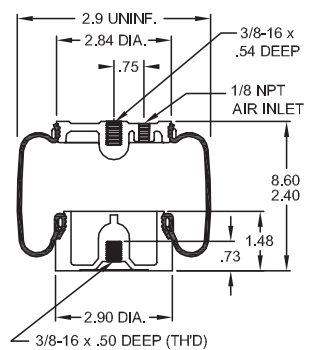
LOGO <b>WHITE</b>	AON <b>W02-358-7035</b>	0.72 Composite
	<p><b>APPLICATIONS:</b> SEARS / DURAFORM S9383 (W02-811-7035) 7025 AL (USE 7035)</p> <p><b>CAP ID NO.</b> NBD-10470 (7068)</p> <p><b>PISTON ID NO.</b> NBD-16537 (6912)</p> <p>BCR <math>\updownarrow</math> 6.50</p>	

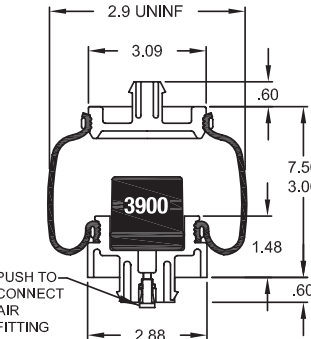
LOGO <b>WHITE</b>	AON <b>W02-358-7206</b>	0.95 Composite
	<p><b>APPLICATIONS:</b> FREIGHTLINER 18-29919-000 CENTURY CLASS &amp; ARGOSY COE (W02-377-7202) 2002 AND EARLIER</p> <p><b>CAP ID NO.</b> NBD-15430 (6987)</p> <p><b>PISTON ID NO.</b> NBD-15431 (6986)</p> <p>BCR <math>\updownarrow</math> 6.50</p> <p><b>REPLACES W02-358-7202</b></p>	

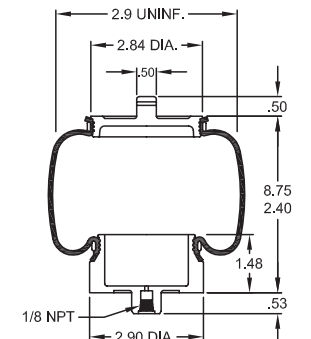
LOGO <b>WHITE</b>	AON <b>W02-358-7087</b>	0.76 Composite
	<p><b>APPLICATIONS:</b> FREIGHTLINER FLD (1988 &amp; LATER) GY 1S5-040</p> <p><b>CAP ID NO.</b> NBD-10409 (7042)</p> <p><b>PISTON ID NO.</b> NBD-16536 (6911)</p> <p>BCR <math>\updownarrow</math> 6.75</p>	

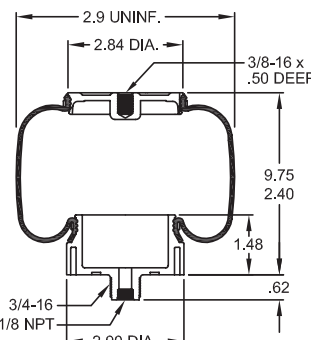
LOGO <b>WHITE</b>	AON <b>W02-358-7075</b>	0.71 Composite
	<p><b>APPLICATIONS:</b> LINK MANUFACTURING LTD 1102-0048</p> <p><b>CAP ID NO.</b> NBD-10218 (7018)</p> <p><b>PISTON ID NO.</b> NBD-16538 (6913)</p> <p>BCR <math>\updownarrow</math> 7.75</p>	

LOGO <b>WHITE</b>	AON <b>W02-358-7037</b>	1.04 Aluminum
	<p><b>APPLICATIONS:</b> AIR FLEX (W02-A05-7037)</p> <p><b>CAP ID NO.</b> NBD-10183 (7013)</p> <p><b>PISTON ID NO.</b> NBD-10795 (7054)</p> <p>BCR <math>\updownarrow</math> 8.00</p> <p><b>OBSOLETE: NO LONGER AVAILABLE</b></p>	

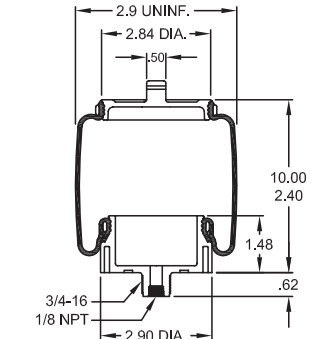
LOGO <b>WHITE</b>	AON <b>W02-358-7061</b>	0.70 Composite
	<p><b>APPLICATIONS:</b> C. E. WHITE</p> <p><b>CAP ID NO.</b> NBD-10409 (7042)</p> <p><b>PISTON ID NO.</b> NBD-16538 (6913)</p> <p>BCR <math>\updownarrow</math> 8.00</p>	

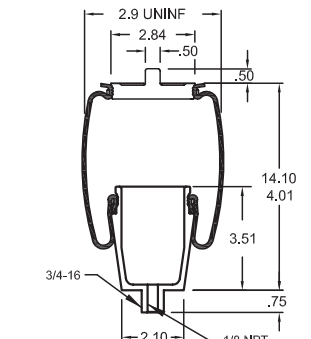
LOGO <b>WHITE</b>	AON <b>W02-358-7074</b>	0.92 Composite
	<p><b>APPLICATIONS:</b> FREIGHTLINER LINK (1102-0047) LINK MANUFACTURING LTD 1102-0045 1102-0047 (FRT.)</p> <p><b>CAP ID NO.</b> NBD-13262 (6997)</p> <p><b>PISTON ID NO.</b> FIP-102216 (9638)</p> <p>BCR <math>\updownarrow</math> 10.12</p>	

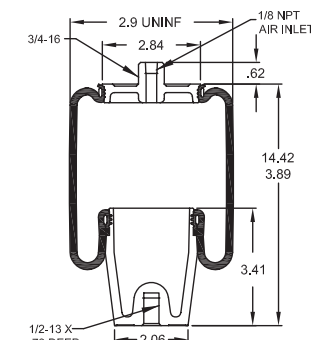
LOGO <b>WHITE</b>	AON <b>W02-358-7012</b>	1.48 Aluminum
	<p><b>APPLICATIONS:</b> LINK MANUFACTURING LTD 1102-0040 RIDE-RITE VANTAGE WHEEL CHAIR</p> <p><b>CAP ID NO.</b> NBD-10010 (7007)</p> <p><b>PISTON ID NO.</b> NBD-10071 (7023)</p> <p>BCR <math>\updownarrow</math> 10.87</p>	

LOGO <b>WHITE</b>	AON <b>W02-358-7042</b>	1.02 Composite
	<p><b>CAP ID NO.</b> NBD-10239 (7015)</p> <p><b>PISTON ID NO.</b> FIP-102217 (9636)</p> <p>BCR <math>\updownarrow</math> 10.87</p>	<p><b>APPLICATIONS:</b> COMFORT RIDE</p>

LOGO <b>WHITE</b>	AON <b>W02-358-7045</b>	0.98 Composite
	<p><b>CAP ID NO.</b> NBD-10409 (7042)</p> <p><b>PISTON ID NO.</b> FIP-102216 (9638)</p> <p>BCR <math>\updownarrow</math> 10.87</p>	<p><b>APPLICATIONS:</b> LINK MANUFACTURING LTD 1102-0042 (WESTERN STAR)</p> <p><b>OBSOLETE: NO LONGER AVAILABLE</b></p>

LOGO <b>WHITE</b>	AON <b>W02-358-7056</b>	1.00 Composite
	<p><b>CAP ID NO.</b> NBD-13262 (6997)</p> <p><b>PISTON ID NO.</b> FIP-102215 (9637)</p> <p>BCR <math>\updownarrow</math> 10.87</p>	<p><b>APPLICATIONS:</b> LINK MANUFACTURING LTD 1102-0043 (FRT. KW, MACK)</p>

LOGO <b>WHITE</b>	AON <b>W02-358-7208</b>	0.94 Composite
	<p><b>CAP ID NO.</b> FIP-100102 (6978)</p> <p><b>PISTON ID NO.</b> FIP-102217 (9636)</p> <p>BCR <math>\updownarrow</math> 11.12</p>	<p><b>APPLICATIONS:</b> SEATS 708015 (W02-812-7208)</p>

LOGO <b>WHITE</b>	AON <b>W02-358-9904</b>	3.89 Composite
	<p><b>CAP ID NO.</b> NAD-25400 (7066)</p> <p><b>PISTON ID NO.</b> NBD-15764 (6980)</p> <p>BCR <math>\updownarrow</math> 16.37</p>	<p><b>APPLICATIONS:</b> LINK 1103-0504</p>

LOGO <b>WHITE</b>	AON <b>W02-358-9901</b>	3.16 Composite
	<p><b>CAP ID NO.</b> NAD-25400 (7066)</p> <p><b>PISTON ID NO.</b> NBD-11340 (7059)</p> <p>BCR <math>\updownarrow</math> 16.67</p>	<p><b>APPLICATIONS:</b> PETERBILT 02-02031 FRONT AXLE AIR SPRING (PRODUCTION-1989 TO 1992)</p>

LOGO <b>MAROON</b>	AON <b>W02-358-7017</b>	1.54 Aluminum
	<p><b>CAP ID NO.</b> NBD-10010 (7007)</p> <p><b>PISTON ID NO.</b> NBD-10071 (7023)</p> <p>BCR <math>\updownarrow</math> 11.50</p>	<p><b>APPLICATIONS:</b> MACK 227QS38</p>

LOGO <b>YELLOW</b>	AON <b>W02-358-4003</b>	1.01 Aluminum
	<p><b>CAP ID NO.</b> NBD-10049 (7009)</p> <p><b>PISTON ID NO.</b> NBD-10514 (7044)</p> <p>BCR <math>\updownarrow</math> 7.25</p>	<p><b>APPLICATIONS:</b> COMFORT RIDE SEARS / DURAFORM S6197 (W02-811-4003)</p>

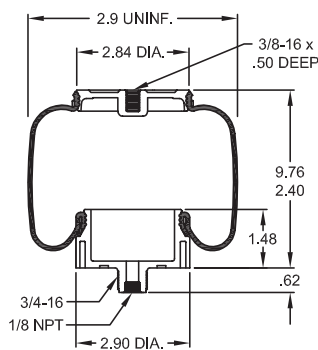
LOGO <b>YELLOW</b>	AON <b>W02-358-7064</b>	0.72 Composite
	<p><b>CAP ID NO.</b> NBD-10218 (7018)</p> <p><b>PISTON ID NO.</b> NBD-16538 (6913)</p> <p>BCR <math>\updownarrow</math> 7.75</p>	<p><b>APPLICATIONS:</b> KENWORTH KW AEROCAB (MID 1999 &amp; EARLIER) LINK (1102-0074) LINK MANUFACTURING LTD 1102-0074 (KW, MARMON)</p>

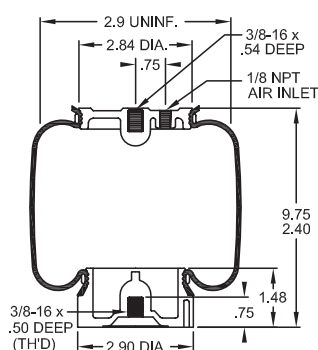
LOGO <b>YELLOW</b>	AON <b>W02-358-7108</b>	0.72 Composite
	<p><b>CAP ID NO.</b> NBD-10470 (7068)</p> <p><b>PISTON ID NO.</b> NBD-16537 (6912)</p> <p>BCR <math>\updownarrow</math> 7.75</p>	<p><b>APPLICATIONS:</b> LINK MANUFACTURING LTD 1102-0075 (NAV.) MILSCO 07067A GY 1S5-057</p>

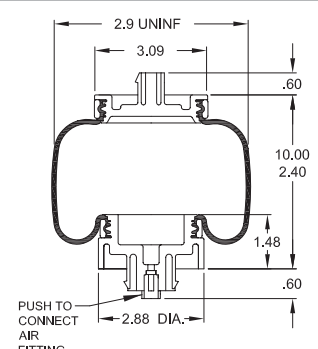
LOGO <b>YELLOW</b>	AON <b>W02-358-7109</b>	0.80 Composite
	<p><b>CAP ID NO.</b> NBD-13706 (6990)</p> <p><b>PISTON ID NO.</b> NBD-14218 (6894)</p> <p>BCR <math>\updownarrow</math> 7.87</p>	<p><b>APPLICATIONS:</b> KENWORTH KW AEROCAB (MID 1999 &amp; LATER) LINK (1102-0077) LINK MANUFACTURING LTD 1102-0077 (KW) T81-1000 KENWORTH</p>

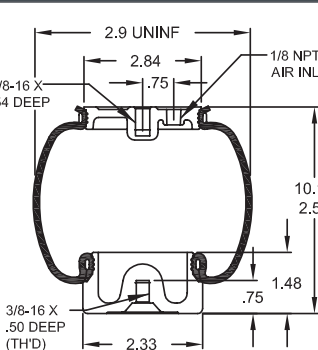
LOGO <b>YELLOW</b>	AON <b>W02-358-7038</b>	1.12 Aluminum
	<p><b>CAP ID NO.</b> NBD-10183 (7013)</p> <p><b>PISTON ID NO.</b> NBD-10795 (7054)</p> <p>BCR <math>\updownarrow</math> 8.00</p>	<p><b>APPLICATIONS:</b> AIR FLEX 7048 AL (USE 7038) DONVEL</p>

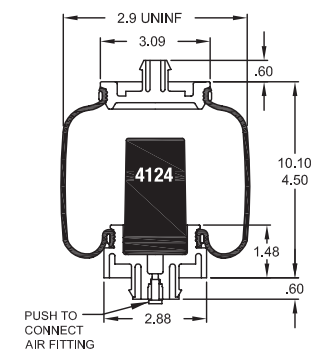
LOGO <b>YELLOW</b>	AON <b>W02-358-7205</b>	1.10 Composite
	<p><b>CAP ID NO.</b> NBD-15430 (6987)</p> <p><b>PISTON ID NO.</b> NBD-15431 (6986)</p> <p>BCR <math>\updownarrow</math> 8.00</p>	<p><b>APPLICATIONS:</b> FREIGHTLINER / WESTERN STAR CONSTELLATION</p> <p><b>REPLACES W02-358-7203</b></p>

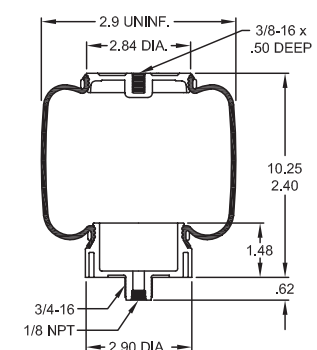
LOGO <b>YELLOW</b>	AON <b>W02-358-7082</b>	0.82 Composite
	<p><b>CAP ID NO.</b> NBD-10218 (7018)</p> <p><b>PISTON ID NO.</b> NBD-16538 (6913)</p> <p>BCR <math>\updownarrow</math> 8.25</p>	<p><b>APPLICATIONS:</b> FREIGHTLINER / WESTERN STAR</p>

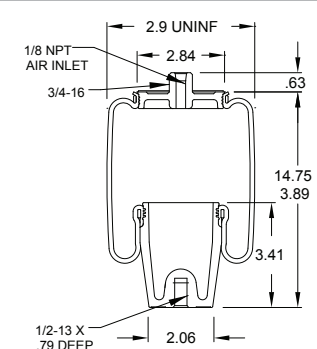
LOGO <b>YELLOW</b>	AON <b>W02-358-7024</b>	1.50 Aluminum
	<p><b>CAP ID NO.</b> NBD-10010 (7007)</p> <p><b>PISTON ID NO.</b> NBD-10071 (7023)</p> <p>BCR <math>\updownarrow</math> 10.00</p>	<p><b>APPLICATIONS:</b> LINK MANUFACTURING LTD 1102-0071</p>

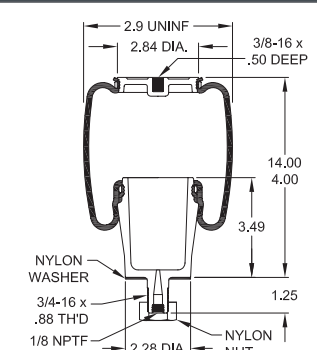
LOGO <b>YELLOW</b>	AON <b>W02-358-7036</b>	1.53 Aluminum
	<p><b>CAP ID NO.</b> NBD-10082 (7014)</p> <p><b>PISTON ID NO.</b> NBD-16484 (6906)</p> <p>BCR <math>\updownarrow</math> 10.00</p>	<p><b>APPLICATIONS:</b> PETERBILT 29-03200 UNI-BUILT - HIGHWAY CAB/ SLEEPER 1993 &amp; LATER UNI-BUILT FT SUPPORT SPRING 7155 PETERBILT T81-6000</p>



LOGO <b>YELLOW</b>	AON <b>W02-358-7215</b>	1.31 Composite
	<p><b>CAP ID NO.</b> NBD-15430 (6987)</p> <p><b>PISTON ID NO.</b> NBD-15431 (6986)</p> <p>BCR <math>\updownarrow</math> 10.43</p>	<p><b>APPLICATIONS:</b> FREIGHTLINER 18-40977-000 CENTURY CLASS ST</p> <p><b>REPLACES W02-358-7111</b></p>

LOGO <b>YELLOW</b>	AON <b>W02-358-7151</b>	1.30 Composite
	<p><b>CAP ID NO.</b> NBD-10470 (7068)</p> <p><b>PISTON ID NO.</b> FIP-102217 (9636)</p> <p>BCR <math>\updownarrow</math> 10.88</p>	<p><b>APPLICATIONS:</b> SEARS / DURAFORM S16894 PISTON ADAPTOR 7802/NBD 14989</p> <p><b>OBSOLETE: NO LONGER AVAILABLE</b></p>

LOGO <b>YELLOW</b>	AON <b>W02-358-7014</b>	1.52 Aluminum
	<p><b>CAP ID NO.</b> NBD-10010 (7007)</p> <p><b>PISTON ID NO.</b> NBD-10071 (7023)</p> <p>BCR <math>\updownarrow</math> 11.50</p>	<p><b>APPLICATIONS:</b></p>

LOGO <b>YELLOW</b>	AON <b>W02-358-7043</b>	1.48 Aluminum
	<p><b>CAP ID NO.</b> NBD-10183 (7013)</p> <p><b>PISTON ID NO.</b> NBD-10071 (7023)</p> <p>BCR <math>\updownarrow</math> 11.50</p>	<p><b>APPLICATIONS:</b> DONVEL</p> <p><b>OBSOLETE: NO LONGER AVAILABLE</b></p>

LOGO <b>YELLOW</b>	AON <b>W02-358-7081</b>	0.92 Composite
	<p><b>CAP ID NO.</b> NBD-10604 (7050)</p> <p><b>PISTON ID NO.</b> FIP-102217 (9636)</p> <p>BCR <math>\updownarrow</math> 11.50</p>	<p><b>APPLICATIONS:</b> NAVISTAR LINK 1102-0076 LINK 1101-0043 GY 1S5-038 LINK MANUFACTURING LTD 1102-0076 (NAV.) NAVISTAR 2501300C1</p>

LOGO <b>YELLOW</b>	AON <b>W02-358-7139</b>	1.20 Aluminum
	<p><b>CAP ID NO.</b> NBD-10082 (7014)</p> <p><b>PISTON ID NO.</b> NBD-16484 (6906)</p> <p>BCR <math>\updownarrow</math> 11.50</p>	<p><b>APPLICATIONS:</b></p>

LOGO <b>BLUE</b>	AON <b>W02-358-7092</b>	0.78 Composite
	<p><b>CAP ID NO.</b> NBD-10218 (7018)</p> <p><b>PISTON ID NO.</b> NBD-16538 (6913)</p> <p>BCR <math>\updownarrow</math> 8.75</p>	<p><b>APPLICATIONS:</b> KENWORTH KWCSA (LINK 1102-0083) LINK MANUFACTURING LTD 1102-0083 (KW)</p>

LOGO <b>BLUE</b>	AON <b>W02-358-7093</b>	1.45 Composite
	<p><b>CAP ID NO.</b> NBD-14314 (6991)</p> <p><b>PISTON ID NO.</b> NBD-14589 (6891)</p> <p>BCR <math>\updownarrow</math> 10.00</p>	<p><b>APPLICATIONS:</b> PETERBILT 29-06016 MODEL 387 (NEW IN 1999)</p>

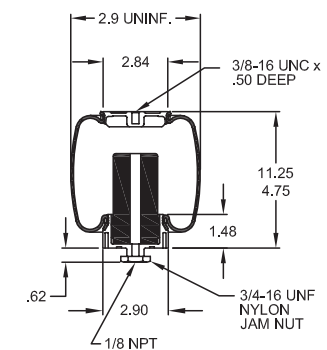
LOGO BLUE	AON <b>W02-358-7200</b>	1.14 Composite
	<p><b>CAP ID NO.</b> NBD-10218 (7018)</p> <p><b>PISTON ID NO.</b> NBD-16538 (6913)</p> <p>BCR <math>\updownarrow</math> 10.25</p>	<p><b>APPLICATIONS:</b> FREIGHTLINER / STERLING 18-42609-000 STERLING SLEEPER OLD FORD # P/N F6HT5C063BA HN-80 SLEEPER (1996 &amp; LATER)</p>

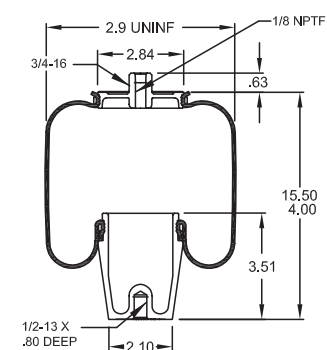
LOGO BLUE	AON <b>W02-358-7083</b>	1.01 Composite
	<p><b>CAP ID NO.</b> NBD-10239 (7015)</p> <p><b>PISTON ID NO.</b> FIP-102217 (9636)</p> <p>BCR <math>\updownarrow</math> 11.50</p>	<p><b>APPLICATIONS:</b> LINK MANUFACTURING LTD 1102-0081 (FRT.)</p>

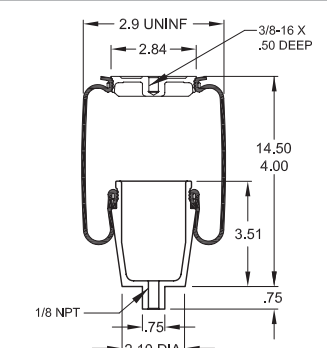
LOGO BLUE	AON <b>W02-358-7110</b>	1.22 Composite
	<p><b>CAP ID NO.</b> NBD-10218 (7018)</p> <p><b>PISTON ID NO.</b> FIP-102215 (9637)</p> <p>BCR <math>\updownarrow</math> 11.75</p>	<p><b>APPLICATIONS:</b> KENWORTH T2000-1998 &amp; LATER LINK (1102-0082) LINK MANUFACTURING LTD 1102-0082 (KW) 1102-K082 KENWORTH R81-1002</p>



Steering axle air springs improve handling and stability, reduce wear and fatigue on other components, and enhance ride comfort. Available exclusively from Firestone.

READING THE PARTS TABLE

<p>1 CAP COLOR <b>BLUE</b></p>	<p>2 AON <b>W26-358-9913</b></p>	<p>6 12.79 7 Composite</p>
	<p>4 CAP ID NO. NAD-30942 (6713)</p> <p>5 PISTON ID NO. NAD-31336 (6888)</p>	<p>8 APPLICATIONS: HENDRICKSON TRUCK 60750-2 VOLVO / MACK</p>

- 1. Cap Color**  
Color of material used on assembly cap.
- 2. Assembly Order Number (AON)**  
Located on the label adhered to the assembly cap. This number is used for ordering purposes. It is important that the complete order number is used to avoid any confusion, especially with any type of electronic ordering. The complete order number in this example is W26-358-9913.
- 3. Cross Section View**  
Includes dimensional information in inches for **uninflated** diameter and height, as well as component dimensions.
- 4. Cap Identification Number**  
Includes the 8-digit cap drawing number and 4-digit cap component number. The 4 digit cap component number might be molded into the perimeter or the top of the air spring cap.
- 5. Piston Identification Number**  
Includes the 8-digit piston drawing number and the 4-digit piston component number. The 4 digit piston component number might be molded into the piston, aiding in identification.
- 6. Weight**  
The total weight of the spring assembly.
- 7. Piston Material**  
Aluminum, Steel, or Composite.
- 8. Applications**  
Includes all the information that is known about this specific application (i.e., model number, years of manufacture, part numbers, Firestone reference numbers, and competitor numbers, if known). If you know the vehicle your part came from, this is often the fastest way to identify the Firestone replacement part.

AIR SPRING IDENTIFICATION

1 Cap Color

Identify the cap color to help you narrow down your selections. If no other information is available, visually refer to the part diagrams to identify your part.

2 Assembly Order Number (AON)

The quickest way to identify the air spring is to read the manufacturer or Firestone assembly order number on the label adhered to the bead plate. Do not confuse this with the stamped 8-digit bead plate number.

4 Cap Identification Number

The 4 digit cap component number might be molded into the perimeter or the top of the air spring cap. Do not confuse this 4 digit code with the OE part number, which is also molded onto the perimeter or cap.

8 OE Part Number

The OE part number is stamped on the cap. Reference the Applications section of the part charts to match the OE part number and identify the Firestone AON.

5 Piston Identification Number

The 4 digit piston component number might be molded into the piston, aiding in identification.



BOTTOM VIEW

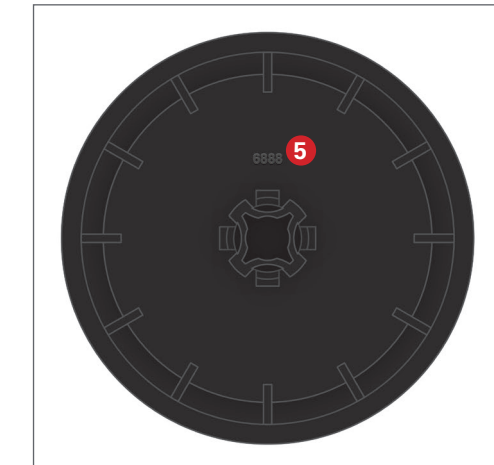

INDUSTRY-LEADING STEERING AXLE SUPPORT  
**ONLY FROM FIRESTONE**



**SAFE**

Improved handling and stability of the truck/trailer unit via steering axle air suspension.



**COMFORTABLE**

Enhanced ride for truck driver as air springs absorb road and vehicle vibrations better than standard steel suspension.



**EASY**

Less maintenance, as air springs reduce overall wear and tear on the suspension and its components.

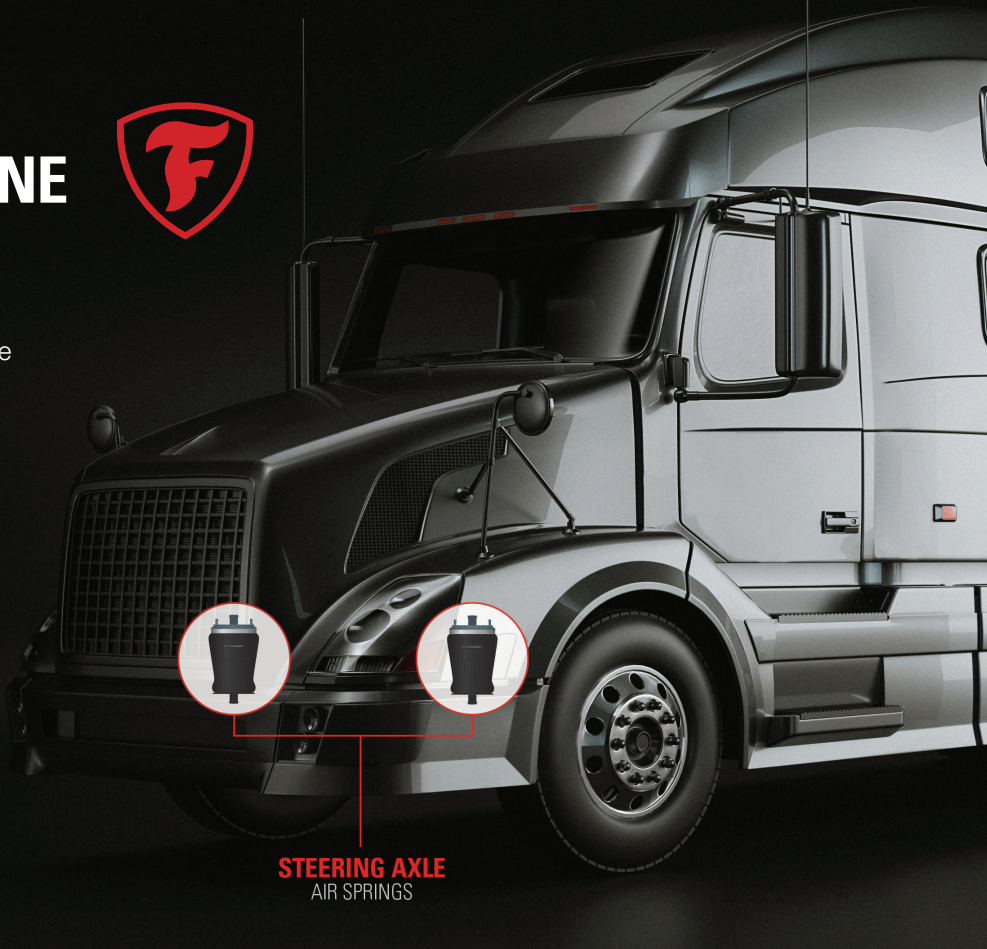

STEERING AXLE AIR SPRINGS

CAP COLOR <b>ALUMINUM</b>	AON <b>W02-358-9901</b>	3.20 Composite
	<p><b>APPLICATIONS:</b>                  PETERBILT 02-02031                  FRONT AXLE AIR SPRING (PRODUCTION 1989-1992)</p>	<p><b>CAP ID NO.</b> NAD-25400 (7066)  <b>PISTON ID NO.</b> NBD-11340 (7059)</p>

CAP COLOR <b>ALUMINUM</b>	AON <b>W26-358-9902</b>	4.40 Aluminum
	<p><b>APPLICATIONS:</b>                  LINK MANUFACTURING LTD 1102-0080</p>	<p><b>CAP ID NO.</b> NBD-13938 (6700)  <b>PISTON ID NO.</b> NBD-13939 (6897)</p>

**Firestone**

**STEERING AXLE SLEEVE STYLE SPRINGS**

CAP COLOR <b>BLACK</b>	AON <b>W26-358-9911</b>	5.50 Composite
	<p><b>APPLICATIONS:</b>                  HENDRICKSON TRUCK 59823-2                  FREIGHTLINER / WESTERN STAR</p>	<p><b>CAP ID NO.</b> NAD-30942 (6711)  <b>PISTON ID NO.</b> NAD-30940 (6890)</p>

CAP COLOR <b>BEIGE</b>	AON <b>W26-358-9912</b>	4.90 Composite
	<p><b>APPLICATIONS:</b>                  HENDRICKSON TRUCK 64075-2                  BLUE BIRD BUS</p>	<p><b>CAP ID NO.</b> NAD-30942 (6714)  <b>PISTON ID NO.</b> NAD-31336 (6888)</p>

CAP COLOR <b>BLUE</b>	AON <b>W26-358-9913</b>	4.90 Composite
	<p><b>APPLICATIONS:</b>                  HENDRICKSON TRUCK 60750-2                  VOLVO / MACK</p>	<p><b>CAP ID NO.</b> NAD-30942 (6713)  <b>PISTON ID NO.</b> NAD-31336 (6888)</p>

CAP COLOR <b>BLACK</b>	AON <b>W26-358-9933</b>	4.70 Composite
	<p><b>APPLICATIONS:</b>                  PACCAR B81-6023</p>	<p><b>CAP ID NO.</b> FIP-100913 (6975)  <b>PISTON ID NO.</b> FIP-100912 (6885)</p>

PRIMARY TRUCK & TRAILER, AUXILIARY / TAG AXLE

**MANUFACTURER TO FIRESTONE NUMBER**

MANUFACTURER/ PART NO.	FIRESTONE ASSEMBLY ORDER NO.	PAGE NO.
<b>3TS</b>		
	W02-358-7103	Call us
<b>AG CHEM</b>		
24869	W01-358-9036	34
50026	W01-358-7512	114
50069	W01-358-7146	106
522285	W01-358-8092	89
<b>AGCO</b>		
24869	W01-358-9036	34
50026	W01-358-7512	114
50069	W01-358-7146	106
522285	W01-358-8092	89
<b>AIR AX (ROELOFS)</b>		
	W01-358-9953	32
<b>AMERICAN CARRIER</b>		
8003001	W01-358-5310	12
8003003	W01-358-9421	66
8003005	W01-358-7146	106
8003006	W01-358-7325	113
8003007	W01-358-7105	Call us
8003009	W01-358-3400	116
8003011	W01-358-5412	14
8003013	W01-358-7093	97
8003023	W01-358-5766	65
8003024	W01-358-5765	Call us
8003025	W01-358-9290	30
8003026	W01-358-3402	116
<b>BELLE TRAILERS</b>		
BT0094	WC1-358-9454	Call us
BT0319	W01-358-9082	46
BT0321	W01-358-9039	34
<b>BELOIT</b>		
274833011	W01-358-9149	83
274852004	W01-358-7103	97
274853D0010019	W01-358-7230	115
274853D0020001	W01-358-7271	114
274853D0020002	W01-358-7276	124
274855D0010005	W01-358-7230	115
274855D0010008	W01-358-7761	122

MANUFACTURER/ PART NO.	FIRESTONE ASSEMBLY ORDER NO.	PAGE NO.
274855D0010009	W01-358-7304	124
274855D0010010	W01-358-7761	122
274855D0020002	W01-358-7276	124
52204-007	W01-358-7180	108
52204-008	W01-358-7185	109
52204-019	W01-358-7145	106
52204-025	W01-358-6910	100
52206-008	W01-358-7304	124
P4-13664-0-1	W01-358-7001	96
P4-13664-0-2	W01-358-7011	97
P4-13664-0-3	W01-358-6900	99
P4-13664-1-10	W01-358-7025	119
P4-13664-1-17	W01-358-7325	113
P4-13664-2-21	W01-358-7008	96
P4-13664-2-24	W01-358-3400	116
P4-13664-3-46	W01-358-7325	113
<b>BERTOJA</b>		
45402002	W01-M58-8775	88
<b>BINKLEY</b>		
XBSPN05337	W01-358-7555	117
XBSPN05360	W01-358-8204	36
<b>BLUE BIRD</b>		
990671	W01-358-9073	29
1263581	W01-358-8997	19
1286814	W01-358-9457	21
300091425	W01-358-8997	19
300961250	W01-358-9039	34
590312B	W01-358-9641	54
<b>BRAKE &amp; WHEEL</b>		
M3500	W01-358-6902	99
M3501	W01-358-6910	100
M3502	W01-358-7135	106
M3503	W01-358-7136	106
M3505	W01-358-7145	106
M3506	W01-358-7400	109
M3507	W01-358-7403	110
M3508	W01-358-7410	111
M3509	W01-358-7424	111
M3510	W01-358-8050	91
M3511	W01-358-9039	34

PRIMARY TRUCK & TRAILER, AUXILIARY / TAG AXLE

**MANUFACTURER TO FIRESTONE NUMBER**

MANUFACTURER/ PART NO.	FIRESTONE ASSEMBLY ORDER NO.	PAGE NO.
M3512	W01-358-9069	42
M3513	W01-358-9082	46
M3514	W01-358-9083	46
M3515	W01-358-9101	57
M3516	W01-358-9105	38
M3517	W01-358-9121	82
M3518	W01-358-9122	85
M3519	W01-358-9130	57
M3520	W01-358-9158	86
M3521	W01-358-9177	83
M3522	W01-358-9213	48
M3523	W01-358-9241	58
M3524	W01-358-9265	61
M3525	W01-358-9422	19
M3526	W01-358-9466	49
M3527	W01-358-6994	96
M3528	W01-358-6897	99
M3530	WC1-358-0361	Call us
M3531	W01-358-7555	117
M3533	W01-358-7808	124
M3534	W01-358-5410	14
M3535	W01-358-8052	91
M3536	W01-358-9075	Call us
M3538	W01-358-9192	57
M3539	W01-358-9194	47
M3540	W01-358-9219	48
M3541	W01-358-9243	58
M3542	W01-358-9270	71
M3543	W01-358-9293	32
M3544	W01-358-9295	33
M3545	W01-358-9321	60
M3546	W01-358-9394	59
M3547	W01-358-9421	66
M3548	W01-358-9923	51
M3550	W01-358-9780	72
<b>CAPACITY OF TEXAS</b>		
	W01-358-5712	17
<b>CATERPILLAR</b>		
1029283	W01-358-9278	64
1416046	W01-358-8235	Call us
	W01-358-9278	64

MANUFACTURER/ PART NO.	FIRESTONE ASSEMBLY ORDER NO.	PAGE NO.
<b>CHALMERS</b>		
07R00005	W01-358-9342	50
	W01-358-7094	98
<b>CHANCE MFG</b>		
23891728	W01-358-9459	22
27003376	W01-358-8990	Call us
27003377	W01-358-9105	38
<b>CIRCLE R</b>		
	W01-358-5422	14
<b>DANA</b>		
SR1VA101	W01-358-8539	80
SR1VA105	W01-358-8539	80
<b>DART</b>		
214048	W01-358-9135	82
1001404	W01-358-7244	115
1016031	W01-358-7294	Call us
1016034	W01-358-9135	82
2140057	W01-358-7244	115
2140061	W01-358-7294	Call us
<b>DAYTON PARTS</b>		
3528050	W01-358-8050	91
3529010	W01-358-9010	41
3529011	W01-358-9011	Call us
3529039	W01-358-9039	34
3529053	W01-358-9053	38
3529069	W01-358-9069	42
3529082	W01-358-9082	46
3529083	W01-358-9083	46
3529096	W01-358-9096	47
3529101	W01-358-9101	57
3529105	W01-358-9105	38
3529121	W01-358-9121	82
3529122	W01-358-9122	85
3529130	W01-358-9130	57
3529148	W01-358-9148	83
3529149	W01-358-9149	83
3529158	W01-358-9158	86
3529177	W01-358-9177	83
3529192	W01-358-9192	57

PRIMARY TRUCK & TRAILER, AUXILIARY / TAG AXLE  
**MANUFACTURER TO FIRESTONE NUMBER**

MANUFACTURER/ PART NO.	FIRESTONE ASSEMBLY ORDER NO.	PAGE NO.
3529194	W01-358-9194	47
3529200	W01-358-9200	80
3529203	W01-358-9203	57
3529213	W01-358-9213	48
3529215	W01-358-9215	81
3529227	W01-358-9227	48
3529238	W01-358-9238	58
3529321	W01-358-9321	60
3529349	W01-358-9349	Call us
3529415	W01-358-9415	24
3529422	W01-358-9422	19
3546801	W01-358-6801	107
3546803	W01-358-6803	107
3546902	W01-358-6902	99
3546905	W01-358-6905	100
3546910	W01-358-6910	100
3546947	W01-358-6947	105
3547112	W01-358-7112	98
3547123	W01-358-7123	105
3547135	W01-358-7135	106
3547136	W01-358-7136	106
3547140	W01-358-7140	106
3547145	W01-358-7145	106
3547146	W01-358-7146	106
3547181	W01-358-7181	108
3547400	W01-358-7400	109
3547403	W01-358-7403	110
3547404	W01-358-7404	110
3547405	W01-358-7405	110
3547410	W01-358-7410	111
3547424	W01-358-7424	111
3547429	W01-358-7429	111
3547437	W01-358-7437	111
3547443	W01-358-7443	112
3547446	W01-358-7446	112
3547447	W01-358-7447	112
3547798	W01-358-7798	123
3547800	W01-358-7800	123
3547808	W01-358-7808	124

MANUFACTURER/ PART NO.	FIRESTONE ASSEMBLY ORDER NO.	PAGE NO.
3547818	W01-358-7818	124
3547839	W01-358-7839	125
3547843	W01-358-7843	125
3547846	W01-358-7846	125
3547847	W01-358-7847	125
3548008	W01-358-8008	120
<b>DINA</b>		
A1812719	W01-358-6900	99
A1Z812719	W01-358-6900	99
A812719	W01-358-6910	100
AZ812719	W01-358-6910	100
<b>DUNLOP</b>		
D12B17	W01-M58-7074	62
D13B02	W01-M58-6339	86
D13B26	W01-M58-6348	89
PNP311770000	W01-M58-6339	86
PNP311780000	W01-M58-8775	88
<b>DURA FORM</b>		
S5388	W02-358-7010	133
<b>E.R.F.</b>		
1392754	W01-358-9101	57
1398550	W01-358-9580	79
1398567	W01-358-7325	113
1426481	W01-358-7403	110
1439083	W01-M58-6339	86
<b>ELDORADO BUS</b>		
7089E000	W01-358-9448	21
71040301	W01-358-8997	19
7113D000	W01-358-5414	14
<b>EZ RIDE</b>		
8030120	W01-358-6905	100
8030150	W01-358-7447	112
8030155	W01-358-8008	120
8030160	W01-358-6801	107
8030170	W01-358-7808	124
8030180	W01-358-7818	124
8030190	W01-358-7180	108
8030192	W01-358-9053	38

PRIMARY TRUCK & TRAILER, AUXILIARY / TAG AXLE  
**MANUFACTURER TO FIRESTONE NUMBER**

MANUFACTURER/ PART NO.	FIRESTONE ASSEMBLY ORDER NO.	PAGE NO.
<b>FAB TEK</b>		
40080	W01-358-7400	109
101243	W01-358-9072	Call us
101357	W01-358-9071	42
101827	W01-358-9039	34
<b>FLXIBLE</b>		
63362	W01-358-5310	12
63367	W01-358-9410	Call us
63791	W01-358-5311	12
63792	W01-358-9031	34
633611	W01-358-5406	13
6304156	W01-358-5710	17
6304156	W01-358-5730	16
6336175	W01-358-5710	17
6336175	W01-358-5730	16
6336195	W01-358-8990	Call us
6336196	W01-358-8997	19
6336200	W01-358-9441	24
6336202	W01-358-9039	34
6336205	W01-358-9105	38
6336212	W01-358-9073	29
6336215	W01-358-9230	Call us
6336217	W01-358-9280	83
97240153	W01-358-9017	29
97999902185	W01-358-9306	35
<b>FODEN</b>		
1300248000	W01-358-9069	42
1300335000	W01-358-9402	65
<b>FORD</b>		
E9HZ5580A	W01-358-9466	49
F2HZ5580A	W01-358-9287	53
F3HS5580AA	W01-358-9335	43
FOHZ5580A	W01-358-9287	53
<b>FREIGHTLINER</b>		
161673000	W01-358-9780	72
161975800	W01-358-9780	72
1610796000	W01-358-7400	109
1611378000	W01-358-7410	111
1613810000	W01-358-9780	72

MANUFACTURER/ PART NO.	FIRESTONE ASSEMBLY ORDER NO.	PAGE NO.
1613810001	W01-358-9780	72
1613810001	W01-358-9782	72
1613810002	W01-358-9780	72
1613810002	W01-358-9780	72
1613840000	W01-358-9781	72
1614263000	W01-358-9634	63
1614263001	W01-358-9634	63
1614377000	W01-358-9780	72
1615443000	W01-358-9634	63
1615443001	W01-358-9634	63
1615444000	W01-358-9634	63
1615762000	W01-358-9774	Call us
1616019000	W01-358-8207	Call us
1616773000	W01-358-9781	72
1616773000	W01-358-9782	72
1619465000	W01-358-9781	72
1619466000	W01-358-9781	72
1619467000	W01-358-9780	72
1619468000	W01-358-9780	72
1619469000	W01-358-9782	72
1619470000	W01-358-9634	63
1619471000	W01-358-9774	Call us
1619769000	W01-358-9780	72
6813200017	W01-358-9781	72
16-10769-000	W01-358-7400	109
16-11378-000	W01-358-7410	111
16-13810-000	W01-358-9780	72
16-13810-000 / 16-13810-001 / 16-13810-002 / 681-320-0017 / A16-14004-000 / A16-14004-001	W01-358-9780	72
16-13810-001	WC1-358-3900	92
16-13810002	WC1-358-3901	92
16-14365-001	WC1-358-3901	92
16-15443-000	W01-358-9634	63
16-15762-000	W01-358-9774	Call us
681-320-0017	W01-358-9780	72
681-320-0017	W01-358-9781	72



PRIMARY TRUCK & TRAILER, AUXILIARY / TAG AXLE

**MANUFACTURER TO FIRESTONE NUMBER**

MANUFACTURER/ PART NO.	FIRESTONE ASSEMBLY ORDER NO.	PAGE NO.
588492	W01-358-8938	37
589832	W01-358-8942	Call us
589952	W01-358-9643	64
590312	W01-358-8941	23
593192	W01-M58-8712	78
594842	W01-358-8971	33
596012	W01-358-8972	Call us
602712	W01-358-9663	55
607162	W01-358-9554	28
609252	W01-358-8817	41
609292	W01-358-8816	41
644892	W01-M58-9372	55
646512	W01-M58-9656	55
649172	W01-358-9647	54
650322	W01-358-9654	54
650862	W01-M58-9851	60
657902	W01-358-8597	28
666432	W01-358-8673	76
670432	W01-358-9865	71
672342	W01-358-8109	77
673912	W01-358-9866	71
698132	W01-358-8723	74
3651410	W01-358-9122	85
3651411	W01-358-9158	86
3651412	W01-358-8052	91
3651413	W01-358-8050	91
20462941	W01-358-9554	28
25158024	W01-358-9375	54
25173621	W01-M58-9656	55
49048000	W01-358-9466	49
58541002	W01-358-8916	23
59484002	W01-358-8971	33
64489002	W01-M58-9372	55
67234002	W01-358-8109	77
98734003	W01-358-9249	68
98734016	W01-358-9017	29
002286/594842	W01-358-8971	33
1R12275	W01-358-9240	58
1R12365	W01-358-9466	49

MANUFACTURER/ PART NO.	FIRESTONE ASSEMBLY ORDER NO.	PAGE NO.
1R12366	W01-358-8944	61
1R12375	W01-358-9265	61
1R13039	W01-358-9228	Call us
1R13118	W01-358-9580	79
1R14172	W01-358-8774	90
1S12027	W01-358-9287	53
1S12030	W01-358-9373	53
2B10226	W01-358-7795	102
45843-1	W01-358-6905	100
45843-3	W01-358-6910	100
48195-2	W01-358-9223	48
57122-2	W01-358-9373	53
57140LH	W01-358-9339	39
57150RH	W01-358-9339	39
57QL411M	W01-358-9466	49
57QL414M	W01-358-9375	54
57QL53M	W01-M58-9656	55
57QL57M	W01-358-9663	55
585202D	W01-M58-9372	55
586542B	W01-M58-9372	55
590102B	W01-358-9641	54
59319-2	W01-M58-8712	78
609252C	W01-358-8817	41
64651-2	W01-358-9297	53
B-12514-013	W01-358-8051	Call us
B-12514-013 (Canada)	W01-358-5523	90
B12514001	W01-358-7403	110
B12514003	W01-358-9302	Call us
B12514004	W01-358-9158	86
B12514005	W01-358-7472	116
B12514007	W01-358-9082	46
B12514008	W01-358-9122	85
B12514010	W01-358-9122	85
B12514011	W01-358-9158	86
B12514012	W01-358-8052	91
B12514013	W01-358-8050	91
B12514014	W01-358-7135	106
B13161	W01-358-9130	57
B2063	W01-M58-6339	86

PRIMARY TRUCK & TRAILER, AUXILIARY / TAG AXLE

**MANUFACTURER TO FIRESTONE NUMBER**

MANUFACTURER/ PART NO.	FIRESTONE ASSEMBLY ORDER NO.	PAGE NO.
B2065	W01-M58-8775	88
B2827	W01-358-9010	41
B3411	W01-358-9228	Call us
B3842	W01-358-9101	57
C20127	W01-358-9580	79
C20223	W01-358-9640	63
C20413	W01-358-9265	61
C21623	W01-358-8755	75
C21624	W01-358-8756	Call us
D22697	W01-358-8724	76
HA100095	W01-358-7472	116
HA360	W01-358-9466	49
HA400	W01-358-9466	49
HA460	W01-358-9466	49
HS506500	W01-358-9580	79
HT-250T	W01-358-9265	61
HT-250U	W01-358-9265	61
HT-250U-Y	W01-358-9265	61
HT250U	W01-358-9580	79
HT250UY	W01-358-9580	79
NA1060	W01-358-7403	110
NA1816	W01-358-7180	108
NA1817	W01-358-9130	57
NA1821	W01-358-7325	113
NA1825	W01-358-7472	116
NA1827	W01-358-7447	112
NS501304	W01-358-9321	60
NS501690	W01-358-8008	120
NS502049	W01-358-9287	53
S-4771 (trailer)	W01-358-5523	90
S1013	W01-358-7400	109
S10170	W01-358-7410	111
S10352	W01-358-9240	58
S10352	W01-358-9394	59
S10443	W01-358-9101	57
S1080	W01-358-7136	106
S11566	W01-358-9010	41
S1159	W01-358-7403	110
S11637	W01-358-8008	120
S11650	W01-358-9039	34

MANUFACTURER/ PART NO.	FIRESTONE ASSEMBLY ORDER NO.	PAGE NO.
S11651	W01-358-9082	46
S12335	W01-358-7472	116
S12353	W01-358-9092	46
S12405	W01-358-8032	122
S12437	W01-358-9122	85
S1245	W01-358-9105	38
S13031	W01-358-9069	42
S13032	W01-358-9422	19
S13033	W01-358-9213	48
S13034	W01-358-7135	106
S13035	W01-358-7443	112
S13036	W01-358-7410	111
S13037	W01-358-7437	111
S13038	W01-358-7145	106
S13039	W01-358-7798	123
S13040	W01-358-9073	29
S13040	W01-358-9415	24
S13041	W01-358-7818	124
S13042	W01-358-9083	46
S13043	W01-358-7424	111
S13044	W01-358-7112	98
S13045	W01-358-9149	83
S13046	W01-358-7146	106
S13047	W01-358-7800	123
S13047	W01-358-7848	126
S13048	W01-358-7123	105
S13049	W01-358-9096	47
S13050	W01-358-7181	108
S13052	W01-358-7429	111
S13053	W01-358-9148	83
S13055	W01-358-7443	112
S13122	W01-358-9264	88
S13154	W01-358-5311	12
S13155	W01-358-5414	14
S13157	W01-358-7808	124
S13158	W01-358-9053	38
S13160	W01-358-9121	82
S13161	W01-358-9130	57
S13163	W01-358-9194	47
S1345	W01-358-7404	110



PRIMARY TRUCK & TRAILER, AUXILIARY / TAG AXLE

**MANUFACTURER TO FIRESTONE NUMBER**

MANUFACTURER/ PART NO.	FIRESTONE ASSEMBLY ORDER NO.	PAGE NO.
S14147	W01-358-9652	31
S14249	W01-358-9367	60
S14318	W01-358-6935	101
S14395	W01-358-7325	113
S14486	W01-358-7795	102
S14487	W01-358-8033	122
S14795	W01-358-8043	127
S1561	W01-358-9083	46
S20010	W01-358-9270	71
S20124	W01-358-9265	61
S20127	W01-358-9580	79
S20157	W01-358-9928	88
S20217	W01-358-8944	61
S20223	W01-358-9640	63
S20413	W01-358-9265	61
S20414	W01-358-9581	79
S2063	W01-358-9158	86
S2064	W01-358-9039	34
S2064/S11650	W01-358-9039	34
S2065	W01-358-9177	83
S2066	W01-358-9082	46
S20716	W01-358-9299	64
S20900	W01-358-8709	78
S20901	W01-358-8091	89
S21208	W01-358-8800	71
S21323	W01-358-6962	105
S21623	W01-358-8755	75
S21624	W01-358-8710	79
S21784	W01-358-8091	89
S21800	W01-358-8709	78
S21966	W01-358-8708	78
S22045	W01-358-8755	75
S22046	W01-358-8710	79
S22173	W01-358-5511	87
S22697	W01-358-8724	76
S22948	W01-358-8713	78
S2307	W01-358-9011	Call us
S23114	W01-358-7897	103
S23321	WC1-358-1694	Call us
S23611	W01-358-9646	61

MANUFACTURER/ PART NO.	FIRESTONE ASSEMBLY ORDER NO.	PAGE NO.
S23612	W01-358-9645	61
S23613	W01-358-9621	27
S23614	W01-358-9619	28
S23720	W01-358-9626	25
S23721	W01-358-9644	61
S23748	W01-358-8093	89
S2394	W01-358-2119	12
S24443	W01-358-8093	89
S25559	W01-358-9270	71
S25873	W01-358-8774	90
S2630	W01-358-6902	99
S26773	W01-358-8614	78
S2694	W01-358-9203	57
S2734	W01-358-6801	107
S27341	W01-358-8774	90
S2827	W01-358-9010	41
S2883	W01-358-7403	110
S28929	W01-358-9978	44
S2924	W01-358-9227	48
S29892	W01-358-8539	80
S29928	W01-358-9978	44
S3184	W01-358-7140	106
S3411	W01-358-9228	Call us
S3467	W01-358-8792	85
S3467	W01-358-9122	85
S3518	W01-358-6905	100
S3648	W01-358-9215	81
S3798	W01-358-7446	112
S3830	W01-358-9122	85
S3839	W01-358-9200	80
S3842	W01-358-9240	58
S4041	W01-358-9082	46
S4375	W01-358-9367	60
S4771	W01-358-8050	91
S4773	W01-358-9392	49
S5060	W01-358-9238	58
S5270	W01-358-6905	100
S5468	W01-358-7404	110
S6195	W01-358-9192	57
S6242	W01-358-7447	112

PRIMARY TRUCK & TRAILER, AUXILIARY / TAG AXLE

**MANUFACTURER TO FIRESTONE NUMBER**

MANUFACTURER/ PART NO.	FIRESTONE ASSEMBLY ORDER NO.	PAGE NO.
S6412	W01-358-6803	107
S6861	W01-358-7839	125
S7100	W01-358-7843	125
S7128	W01-358-9156	85
S7193	W01-358-9073	29
S7364	W01-358-9285	30
S7853	W01-358-7846	125
S8701	W01-358-6947	105
S8768	W01-358-6910	100
S8832	W01-358-5310	12
S8874	W01-358-7847	125
S8988	W01-358-9349	Call us
S9346	W01-358-5405	13
S9830	W01-358-7444	112
XDB1561	W01-358-9083	46
Y505801	W01-M58-6339	86
Y505859	W01-M58-6339	86
Y506201	W01-M58-8775	88
Y506243	W01-M58-8775	88
Y50624301	W01-M58-8775	88
<b>HISTEER</b>		
10300	W01-358-7839	125
10301	W01-358-7850	126
10302	W01-358-6941	101
10303	W01-358-8039	127
10305	W01-358-6940	101
10307	W01-358-6944	104
10313	W01-358-8038	127
10315	W01-358-7550	117
10316	W01-358-7557	117
<b>HUTCHENS</b>		
1914101	W01-358-5766	65
H1038401	W01-358-7405	110
H19131	W01-358-9059	42
H2007	W01-358-9075	
H936001	W01-358-9082	46
H942401	W01-358-9039	34
H963001	W01-358-9082	46

MANUFACTURER/ PART NO.	FIRESTONE ASSEMBLY ORDER NO.	PAGE NO.
<b>INGERSOLL RAND</b>		
59302786	W01-358-6910	100
<b>IVECO</b>		
504035755	W01-358-5343	13
<b>JET CO.</b>		
	W01-358-9260	64
<b>JOHN DEERE</b>		
AH160823	W01-358-5336	15
AN205362	W01-358-8931	37
AN205761	W01-M58-8798	89
AW30683	W01-358-6831	118
AW34652	W01-358-6831	118
<b>KASSBOHRER</b>		
4731033000	W01-M58-6339	86
<b>KENWORTH</b>		
C811003	W01-358-8813	41
C811004	W01-358-9547	25
C811005	W01-358-9541	26
K-303-15	W01-358-9422	19
K-303-18	W01-358-9617	25
K-303-22	W01-358-9622	26
K-303-25	W01-358-9625	26
K-303-28	W01-358-9675	26
K-303-5	W01-358-9415	24
K102A	W01-358-9073	29
K30314	W01-358-9422	19
K30315	W01-358-9422	19
K30316	W01-358-9616	20
K30318	W01-358-9617	25
K30319	W01-358-9618	26
K30319	W01-358-9622	26
K30322	W01-358-9622	26
K30323	W01-358-9625	26
K30325	W01-358-9625	26
K30325	W01-358-9625	26
K30328	W01-358-9675	26
K3035	W01-358-9415	24
K3036	W01-358-9422	19

PRIMARY TRUCK & TRAILER, AUXILIARY / TAG AXLE

**MANUFACTURER TO FIRESTONE NUMBER**

MANUFACTURER/ PART NO.	FIRESTONE ASSEMBLY ORDER NO.	PAGE NO.
<b>KNOEDLER</b>		
9212	W02-358-7010	133
<b>KWIC LOCK</b>		
53671	W01-358-7123	105
CP5125	W01-358-9082	46
CP5223	W01-358-7429	111
<b>LEYLAND</b>		
SC2010	W01-358-6902	99
SC2011	W01-358-6910	100
SC2012	W01-358-7112	98
SC2013	W01-358-7135	106
SC2014	W01-358-7136	106
SC2015	W01-358-7140	106
SC2016	W01-358-7145	106
SC2017	W01-358-7146	106
SC2018	W01-358-7181	108
SC2019	W01-358-7183	109
SC2020	W01-358-7400	109
SC2021	W01-358-7403	110
SC2022	W01-358-7404	110
SC2023	W01-358-7410	111
SC2024	W01-358-7424	111
SC2025	W01-358-7437	111
SC2026	W01-358-7443	112
SC2027	W01-358-7446	112
SC2028	W01-358-7447	112
SC2029	W01-358-7798	123
SC2030	W01-358-7800	123
SC2030	W01-358-7848	126
SC2031	W01-358-7808	124
SC2032	W01-358-7818	124
SC2032	W01-358-7839	125
SC2033	W01-358-9039	34
SC2034	W01-358-9069	42
SC2035	W01-358-9082	46
SC2036	W01-358-9083	46
SC2038	W01-358-9101	57
SC2039	W01-358-9105	38
SC2040	W01-358-9121	82

MANUFACTURER/ PART NO.	FIRESTONE ASSEMBLY ORDER NO.	PAGE NO.
SC2041	W01-358-9122	85
SC2042	W01-358-9148	83
SC2043	W01-358-9149	83
SC2044	W01-358-9156	85
SC2045	W01-358-9158	86
SC2046	W01-358-9177	83
SC2047	W01-358-9215	81
SC2048	W01-358-9213	48
SC2050	W01-358-9422	19
SC2051	W01-358-9096	47
SC2052	W01-358-8050	91
SC2070	W01-358-9219	48
SC2071	W01-358-6905	100
SC2072	W01-358-6927	104
SC2073	W01-358-7405	110
SC2074	W01-358-7409	110
SC2075	W01-358-7180	108
SC2076	W01-358-7406	Call us
SC2077	W01-358-7429	111
SC2078	W01-358-7473	112
SC2079	W01-358-6801	107
SC2080	W01-358-7123	105
SC2098	W01-358-9122	85
SC2102	W01-358-9192	57
SC2108	W01-358-9241	58
SC2109	W01-358-9238	58
SC2110	W01-358-9379	27
SC2116	W01-358-9200	80
SC2119	W01-358-8010	120
SC2120	W01-358-9321	60
SC2121	W01-358-8052	91
SC2122	W01-358-6943	104
SC2123	W01-358-6948	105
SC2124	W01-358-6944	104
SC2125	W01-358-6945	104
SC2126	W01-358-6946	104
SC2127	W01-358-6947	105
SC2129	W01-358-6803	107
SC2130	W01-358-8008	120

PRIMARY TRUCK & TRAILER, AUXILIARY / TAG AXLE

**MANUFACTURER TO FIRESTONE NUMBER**

MANUFACTURER/ PART NO.	FIRESTONE ASSEMBLY ORDER NO.	PAGE NO.
SC2131	W01-358-8018	121
SC2132	W01-358-8006	120
SC2134	W01-358-9203	57
SC2135	W01-358-7843	125
SC2136	W01-358-7847	125
SC2457	W01-358-9053	38
SC2464	W01-358-9130	57
<b>LINK</b>		
(see 5789)	W01-358-5772	66
11020020	W02-358-7002	131
11020023	W02-358-7001	131
11030019	W01-358-6884	99
11030056	W01-358-7996	120
11030058	W01-358-8842	55
11030059	W01-358-5900	103
11030500	W01-358-5439	16
11030501	W01-358-9562	22
11030503	W01-358-5789	67
11030510	W01-358-8492	29
1102K023	W02-358-7001	131
R811001	W02-358-7001	131
<b>LOAD AIR</b>		
P10755C	W01-358-7344	109
P10794	W01-358-7057	119
P10872A	W01-358-6949	101
P60733	W01-358-9221	83
<b>MACK</b>		
227QS32	W01-358-7325	113
364QS27	W01-358-9375	54
364QS28	W01-358-9466	49
57QK1113	W01-358-7325	113
57QL1115	W01-358-9652	31
57QL239	W01-358-7145	106
57QL310	W01-358-9082	46
57QL411M	W01-358-9466	49
57QL414M	W01-358-9375	54
57QL417M	W01-358-9647	54
57QL46	W01-358-7135	106
57QL53M	W01-M58-9656	55
57QL57M	W01-358-9663	55

MANUFACTURER/ PART NO.	FIRESTONE ASSEMBLY ORDER NO.	PAGE NO.
<b>MASA</b>		
227002002	W01-358-7400	109
227138412	W01-358-6900	99
K27137295	W01-358-9105	38
T27129063	W01-358-9010	41
<b>MAURICE WELDING</b>		
	W01-358-7852	122
	W01-358-7927	115
<b>MCI</b>		
393902468	W01-358-5770	66
<b>MCMaster-CARR</b>		
9538K62	W02-358-7002	131
9551K64	W01-358-7845	125
9551K82	W01-358-7180	108
<b>MERITOR</b>		
8619	W01-358-9376	20
200041	W01-358-9241	58
200042	W01-358-6902	99
200117	W01-358-8027	121
200118	W01-358-6944	104
200154	W01-358-9105	38
200175	W01-358-7088	Call us
200177	W01-358-7850	126
200180	W01-358-6946	104
200182	W01-358-9251	Call us
200183	W01-358-6949	101
200448	W01-358-7403	110
200457	W01-358-9039	34
200458	W01-358-9200	80
200504	W01-358-5503	86
200620	W01-358-8006	120
200793	W01-358-5311	12
200981	W01-358-7405	110
201150	W01-358-9249	68
201222	W01-358-9218	81
201293	W01-358-7043	97
201339	W01-358-7446	112
201364	W01-358-7446	112
201377	W01-358-6801	107

PRIMARY TRUCK & TRAILER, AUXILIARY / TAG AXLE

**MANUFACTURER TO FIRESTONE NUMBER**

MANUFACTURER/ PART NO.	FIRESTONE ASSEMBLY ORDER NO.	PAGE NO.
201498	W01-358-7848	126
201548	W01-358-6935	101
201602	W01-358-7499	Call us
201680	W01-358-8050	91
201847	W01-358-7794	Call us
201869	W01-358-9082	46
202035	W01-358-9192	57
202219	W01-358-9093	47
202263	W01-358-9928	88
202394	W01-358-8018	121
202796	W01-358-8617	79
202796	W01-358-8729	76
203022	W01-358-7843	125
17204517	W01-M58-8775	88
21208082	W01-M58-8775	88
21208939	W01-358-9039	34
21215632	W01-M58-8775	88
21215633	W01-M58-6339	86
21216135	W01-358-9039	34
21222442	W01-M58-7074	62
21227742	W01-358-6231	62
21227742	W01-358-6262	62
21227892	W01-358-6258	71
22581451	W01-358-9459	22
000L21223269	W01-358-9391	24
21227742 FS25	W01-358-6262	62
21227742FS25	W01-358-6231	62
21227892 FS25	W01-358-6258	71
2258A1483	W01-358-8878	37
2258C1459	W01-358-8203	36
2258G1489	W01-358-6392	103
2258J1466	W01-358-9553	Call us
2258N1470	W01-358-9249	68
2258P1576	W01-358-8091	89
2258U1451	W01-358-9459	22
A-2258-C-1459	W01-358-8203	36
A-2258-U-1451	W01-358-9459	22
A22581451	W01-358-9459	22
A2258A1457	W01-358-8171	107

MANUFACTURER/ PART NO.	FIRESTONE ASSEMBLY ORDER NO.	PAGE NO.
A2258A1483	W01-358-8878	37
A2258C1459	W01-358-8203	36
A2258E1461	W01-358-8617	79
A2258F1410	W01-358-8729	76
A2258G1489	W01-358-6392	103
A2258J1466	W01-358-9553	Call us
A2258N1470	W01-358-9249	68
A2258P1576	W01-358-8091	89
<b>MONACO COACH</b>		
8618	W01-358-5319	18
8619	W01-358-9376	20
14002	W01-358-9376	20
1804591	W01-358-8897	20
1806160	W01-358-9651	65
<b>NATIONAL SEATING</b>		
2112283	W02-358-7050	Call us
2123403	W02-358-7001	131
2123403	W02-358-7002	131
<b>NAVISTAR</b>		
1622372C1	W01-358-9287	53
1660581C1	W01-358-9213	48
1660694C1	W01-358-9379	27
1670043C1	W01-358-9371	53
1670073C1	W01-358-9371	53
1672401C1	W01-358-9566	27
1675495C1	W01-358-9568	28
1681579C1	W01-358-9241	58
1681737C1	W01-358-9238	58
1681738C1	W01-358-9192	57
1681739C1	W01-358-9219	48
1681740C1	W01-358-9192	57
1681741C1	W01-358-9149	83
1681742C1	W01-358-9156	85
1681743C1	W01-358-9148	83
1681745C1	W01-358-9158	86
1681746C1	W01-358-9200	80
1681747C1	W01-358-8052	91
1681748C1	W01-358-9144	82
1681749C1	W01-358-9122	85

PRIMARY TRUCK & TRAILER, AUXILIARY / TAG AXLE

**MANUFACTURER TO FIRESTONE NUMBER**

MANUFACTURER/ PART NO.	FIRESTONE ASSEMBLY ORDER NO.	PAGE NO.
1681750C1	W01-358-7423	111
1681751C1	W01-358-7472	116
1685174C1	W01-358-8050	91
1685175C1	W01-358-6905	100
1685177C1	W01-358-7405	110
1685178C1	W01-358-7409	110
1685179C1	W01-358-7180	108
1685180C1	W01-358-7406	Call us
1685181C1	W01-358-7429	111
1685182C1	W01-358-7473	112
1685183C1	W01-358-6801	107
1685184C1	W01-358-7123	105
1686386C1	W01-358-9371	53
1R12523	W01-358-1190	73
2027911C1	W01-358-9371	53
2027911C1	W01-358-9648	73
2027911C2	W01-358-9648	73
2027911C3	W01-358-9648	73
2027912C1	W01-358-9565	27
2027913C1	W01-358-9567	27
2027913C1	W01-358-9568	28
202791C1	W01-358-9566	27
3541731C1	W01-358-1191	73
3541732C1	W01-358-1190	73
3541732C1	W01-358-1190	73
3691773C1	W01-358-1192	73
501559C1	W01-358-9213	48
501559C2	W01-358-9213	48
517096C91	W01-358-9092	46
517559C9	W01-358-9082	46
554761C1	W01-358-9415	24
554762C1	W01-358-9422	19
554763C1	W01-358-9083	46
554764C1	W01-358-9069	42
554766C1	W01-358-9039	34
554770C1	W01-358-9105	38
554771C1	W01-358-9096	47
554772C1	W01-358-9122	85

MANUFACTURER/ PART NO.	FIRESTONE ASSEMBLY ORDER NO.	PAGE NO.
554773C1	W01-358-9121	82
554776C1	W01-358-9149	83
554777C1	W01-358-9156	85
554778C1	W01-358-9148	83
554779C1	W01-358-9177	83
554780C1	W01-358-9158	86
554781C1	W01-358-9215	81
554782C1	W01-358-7112	98
554783C1	W01-358-6910	100
554784C1	W01-358-6902	99
554785C1	W01-358-7424	111
554786C1	W01-358-7443	112
554787C1	W01-358-7403	110
554788C1	W01-358-7400	109
554789C1	W01-358-7401	109
554789C1	W01-358-7437	111
554790C1	W01-358-7447	112
554791C1	W01-358-7446	112
554792C1	W01-358-7410	111
554793C1	W01-358-7404	110
554794C1	W01-358-7181	108
554795C1	W01-358-7183	109
554796C1	W01-358-7145	106
554797C1	W01-358-7146	106
554798C1	W01-358-7136	106
554799C1	W01-358-7140	106
554800C1	W01-358-7135	106
554801C1	W01-358-7808	124
<b>NEOPLAN</b>		
BJ1003010	W01-358-9280	83
KH1003010	W01-358-8980	82
MD1003009	W01-358-9105	38
<b>NEW FLYER</b>		
5920815	W01-358-5406	13
<b>NEWLITE</b>		
NS19016	W01-358-8204	36

PRIMARY TRUCK &amp; TRAILER, AUXILIARY / TAG AXLE

**MANUFACTURER TO FIRESTONE NUMBER**

MANUFACTURER/ PART NO.	FIRESTONE ASSEMBLY ORDER NO.	PAGE NO.
<b>NOVABUS</b>		
G1012381	W01-358-9017	29
G1019358	W01-358-9017	29
G1019449	W01-358-9017	29
G1019450	W01-358-9017	29
G1020957	W01-358-9017	29
G5001705	W01-358-5730	16
G5001706	W01-358-9017	29
N15558	W01-358-9017	29
N16374	W01-358-9441	24
N17842	W01-358-8828	62
<b>NUMATICS</b>		
ASND3161	W01-358-6900	99
ASND8271	W01-358-9529	108
ASNS5131	W01-358-7011	97
<b>ORION</b>		
10132404	W01-358-9306	35
50232501	W01-358-8970	35
101324014	W01-358-9039	34
<b>OSHKOSH</b>		
8013	W01-358-8010	120
3620210	W01-358-8781	84
RX0803	W01-358-9269	Call us
<b>OTTAWA</b>		
7131503	W01-358-8616	77
50232501	W01-358-8970	35
53500516	W01-358-7304	124
<b>PACCAR</b>		
C811011	W01-358-8864	56
C811012	W01-358-8813	41
C811013	W01-358-8864	56
<b>PEERLESS</b>		
5500051	W01-358-9031	34
55000001	W01-358-7180	108
55000010	W01-358-9149	83
55000015	W01-358-7103	97
55000030	W01-358-7808	124
55000051	W01-358-9031	34
55000070	W01-358-9148	83
55000080	W01-358-9156	85

MANUFACTURER/ PART NO.	FIRESTONE ASSEMBLY ORDER NO.	PAGE NO.
<b>PEGASO</b>		
175005	W01-M58-6339	86
<b>PETERBILT</b>		
301649	W01-358-9069	42
301686	W01-358-8478	29
302038	W01-358-9069	42
302456	W01-358-9069	42
304759	W01-358-9069	42
305107	W01-358-9194	47
306213	W01-358-9026	46
306746	W01-358-9069	42
307111	W01-358-9026	46
307112	W01-358-9069	42
0307887	W01-358-8852	56
308424	W01-358-8478	29
308716	W01-358-8864	56
310042	W01-358-9069	42
C816000	W01-358-8813	41
C816022	W01-358-9069	42
<b>PIONEER</b>		
	W01-358-9071	42
<b>PIRELLI</b>		
93029	W01-358-7001	96
94016	W01-358-7008	96
<b>PREVOST</b>		
630044	W01-358-9380	Call us
630045	W01-358-9073	29
630158	W01-358-9017	29
630173	W01-358-6900	99
630174	W01-358-6910	100
630194	W01-358-9017	29
630226	W01-358-5730	16
<b>RENAULT</b>		
Midlum 250 Truck	W01-M58-8712	78
<b>REXROTH-MECMAN</b>		
299-934-000-0	W01-358-3400	116
299-969-000-0	W01-358-6910	100
299-970-010-0	W01-358-7001	96
299-970-110-0	W01-358-7008	96
299-970-250-0	W01-358-7025	119

PRIMARY TRUCK &amp; TRAILER, AUXILIARY / TAG AXLE

**MANUFACTURER TO FIRESTONE NUMBER**

MANUFACTURER/ PART NO.	FIRESTONE ASSEMBLY ORDER NO.	PAGE NO.
299-971-010-0	W01-358-7103	97
299-971-430-0	W01-358-7145	106
299-971-840-0	W01-358-7180	108
299-973-010-0	W01-358-7230	115
299-973-040-0	W01-358-7304	124
299-973-200-0	W01-358-7304	124
299-973-270-0	W01-358-7325	113
299-974-420-0	W01-358-7444	112
299-975-980-0	W01-358-7598	Call us
299-977-610-0	W01-358-7761	122
299-978-020-0	W01-358-7808	124
299-978-420-0	W01-358-7845	125
299-995-290-0	W01-358-6800	107
<b>REYCO GRANNING</b>		
1014	W01-358-7818	124
1015	W01-358-7140	106
1218	W01-358-7443	112
1359	W01-358-9083	46
1371	W01-358-6910	100
1613	W01-358-7798	123
1626	W01-358-7136	106
1971	W01-358-5406	13
2112	W01-358-5410	14
2279	W01-358-7118	Call us
2303	WC1-358-9452	Call us
2524	W01-358-7286	122
2577	W01-358-9210	47
2598	W01-358-9214	Call us
2692	W01-358-9211	48
2725	W01-358-7403	110
2726	W01-358-7400	109
2727	W01-358-9342	50
4848	W01-358-6902	99
5065	W01-358-9105	38
5122	W01-358-2119	12
5235	W01-358-5423	14
5301	W01-358-8977	16
5307	W01-358-5423	14
5385	W01-358-8922	23
5492	W01-358-8922	23

MANUFACTURER/ PART NO.	FIRESTONE ASSEMBLY ORDER NO.	PAGE NO.
5553	W01-358-8979	17
5691	W01-358-2120	12
6057	W01-358-8965	Call us
6104	W01-358-2120	12
6117	W01-358-5426	17
6250	W01-358-9478	15
6252	W01-358-9049	29
6352	W01-358-6943	104
6389	W01-358-6905	100
6390	W01-358-6944	104
6391	W01-358-7446	112
6392	W01-358-8008	120
6393	W01-358-8018	121
6394	W01-358-9122	85
6396	W01-358-9245	58
6418	W01-358-9082	46
6419	W01-358-7112	98
6420	W01-358-7135	106
6421	W01-358-7424	111
6422	W01-358-7437	111
6424	W01-358-9121	82
6425	W01-358-9158	86
6426	W01-358-9177	83
6427	W01-358-9250	70
6428	W01-358-9275	69
6429	W01-358-9421	66
6941	W01-358-9101	57
7025	W01-358-6960	105
7026	W01-358-7855	Call us
7504	W01-358-5323	13
7593	W01-358-8760	80
7692	W01-358-8918	Call us
7765	W01-358-5434	15
7831	W01-358-5436	Call us
7901	W01-358-8735	79
8221	W01-358-7996	120
8273	W01-358-9825	90
8452	W01-358-9947	52
8609	W01-358-5702	17
1288201	W01-358-9082	46



PRIMARY TRUCK & TRAILER, AUXILIARY / TAG AXLE

**MANUFACTURER TO FIRESTONE NUMBER**

MANUFACTURER/ PART NO.	FIRESTONE ASSEMBLY ORDER NO.	PAGE NO.
1003588963C	W01-358-8963	33
1003588986C	W01-358-8986	Call us
1003588991C	W01-358-8991	37
1003588992C	W01-358-8992	19
1003588997C	W01-358-8997	19
1003588997C1	W01-358-8997	19
1003589008C	W01-358-9008	Call us
1003589010C	W01-358-9010	41
1003589029C	W01-358-9029	Call us
1003589031C	W01-358-9031	34
1003589033C	W01-358-9033	34
1003589039C	W01-358-9039	34
1003589053C	W01-358-9053	38
1003589059C	W01-358-9059	42
1003589069C	W01-358-9069	42
1003589070C	W01-358-9070	42
1003589071C	W01-358-9071	42
1003589073C	W01-358-9073	29
1003589075C	W01-358-9075	Call us
1003589077C	W01-358-9077	Call us
1003589078C	W01-358-9078	38
1003589082C	W01-358-9082	46
1003589083C	W01-358-9083	46
1003589096C	W01-358-9096	47
1003589101C	W01-358-9101	57
1003589105C	W01-358-9105	38
1003589118C	W01-358-9118	38
1003589121C	W01-358-9121	82
1003589122C	W01-358-9122	85
1003589149C	W01-358-9149	83
1003589158C	W01-358-9158	86
1003589177C	W01-358-9177	83
1003589192C	W01-358-9192	57
1003589200C	W01-358-9200	80
1003589203C	W01-358-9203	57
1003589213C	W01-358-9213	48
1003589218C	W01-358-9218	81
1003589219C	W01-358-9219	48
1003589223C	W01-358-9223	48

MANUFACTURER/ PART NO.	FIRESTONE ASSEMBLY ORDER NO.	PAGE NO.
1003589245C	W01-358-9245	58
1003589250C	W01-358-9250	70
1003589251C	W01-358-9251	Call us
1003589270C	W01-358-9270	71
1003589274C	W01-358-9274	68
1003589275C	W01-358-9275	69
1003589290C	W01-358-9290	30
1003589308C	W01-358-9308	34
1003589320C	W01-358-9320	59
1003589321C	W01-358-9321	60
1003589334C	W01-358-9334	35
1003589368C	W01-358-9368	60
1003589370C	W01-358-9370	60
1003589378C	W01-358-9378	Call us
1003589387C	W01-358-9387	21
1003589394C	W01-358-9394	59
1003589415C	W01-358-9415	24
1003589421C	W01-358-9421	66
1003589422C	W01-358-9422	19
1003589423C	W01-358-9423	66
1003589445C	W01-358-9445	21
1003589447C	W01-358-9447	21
1003589448C	W01-358-9448	21
1003589457C	W01-358-9457	21
1003589459C	W01-358-9459	22
1003589459C1	W01-358-9459	22
1003589467C	W01-358-9467	43
1003589477C	W01-358-9477	22
1003589538C	W01-358-9538	Call us
1003589595C	W01-358-9595	31
1003589780C	W01-358-9780	72
1003589797C	W01-358-9797	44
1003589961C	W01-358-9961	Call us
1003599083C	W01-358-9083	46
101015P453	W01-358-8709	78
101015S453	W01-358-8709	78
101015S518	W01-358-8752	74
101015S522	W01-358-8755	75
101015S711	W01-358-8710	79

PRIMARY TRUCK & TRAILER, AUXILIARY / TAG AXLE

**MANUFACTURER TO FIRESTONE NUMBER**

MANUFACTURER/ PART NO.	FIRESTONE ASSEMBLY ORDER NO.	PAGE NO.
101015S713	W01-358-8753	74
101015S773	W01-358-8740	74
101015s871	W01-358-8782	75
101016S526	W01-358-8708	78
101016S533	W01-358-8713	78
101021P434	W01-358-9580	79
101021P486	W01-358-8749	76
101021P570	W01-358-8748	76
10105av12p513	W01-358-8729	76
10105BV16P273	W01-358-8539	80
10105P460	W01-358-8709	78
1010B13S513	W01-358-8729	76
1013589039C	W01-358-9039	34
S2061C	W01-358-9039	34
S3081C	W01-358-8992	19
<b>ROR</b>		
21222442	W01-M58-7074	62
<b>ROWE TRUCK</b>		
0027ASC2500	W01-358-8888	50
0035ASC1600	W01-358-7686	101
0035ASC2500	W01-358-7686	101
0059ASC1500	W01-358-7956	127
0266ASC1600HL	W01-358-9811	84
<b>RR LOAD</b>		
LS150	W01-358-7462	98
LS20	W01-358-6926	100
<b>RS TRUCK</b>		
1027405	W01-358-6910	100
1027505	W01-358-6902	99
1027519	W01-358-7400	109
1027556	W01-358-7136	106
1040201	W01-358-7403	110
1082914	W01-358-7446	112
1090023	W01-358-9121	82
1090214	W01-358-7140	106
1090215	W01-358-7424	111
1090216	W01-358-9177	83
1090217	W01-358-9082	46
1090218	W01-358-9039	34

MANUFACTURER/ PART NO.	FIRESTONE ASSEMBLY ORDER NO.	PAGE NO.
<b>SAF HOLLAND</b>		
6764	W01-358-7304	124
6788	W01-358-7230	115
8454	W01-358-9936	52
50857000	W01-358-9807	39
57005410	W01-358-5410	14
57006801	W01-358-6801	107
57006803	W01-358-6803	107
57006902	W01-358-6902	99
57006905	W01-358-6905	100
57006910	W01-358-6910	100
57006927	W01-358-6927	104
57006941	W01-358-6941	101
57006947	W01-358-6947	105
57007123	W01-358-7123	105
57007136	W01-358-7136	106
57007140	W01-358-7140	106
57007145	W01-358-7145	106
57007180	W01-358-7180	108
57007181	W01-358-7181	108
57007183	W01-358-7183	109
57007325	W01-358-7325	113
57007401	W01-358-7401	109
57007403	W01-358-7403	110
57007404	W01-358-7404	110
57007405	W01-358-7405	110
57007406	W01-358-7406	Call us
57007409	W01-358-7409	110
57007410	W01-358-7410	111
57007429	W01-358-7429	111
57007443	W01-358-7443	112
57007446	W01-358-7446	112
57007447	W01-358-7447	112
57007472	W01-358-7472	116
57007473	W01-358-7473	112
57007798	W01-358-7798	123
57007800	W01-358-7800	123
57007808	W01-358-7808	124
57007818	W01-358-7818	124

PRIMARY TRUCK & TRAILER, AUXILIARY / TAG AXLE

**MANUFACTURER TO FIRESTONE NUMBER**

MANUFACTURER/ PART NO.	FIRESTONE ASSEMBLY ORDER NO.	PAGE NO.
57007839	W01-358-7839	125
57008008	W01-358-8008	120
57008050	W01-358-8050	91
57008052	W01-358-8052	91
57009053	W01-358-9053	38
57009069	W01-358-9069	42
57009073	W01-358-9073	29
57009077	W01-358-9077	Call us
57009078	W01-358-9078	38
57009083	W01-358-9083	46
57009096	W01-358-9096	47
57009105	W01-358-9105	38
57009130	W01-358-9130	57
57009149	W01-358-9149	83
57009194	W01-358-9194	47
57009200	W01-358-9200	80
57009210	W01-358-9210	47
57009213	W01-358-9213	48
57009215	W01-358-9215	81
57009219	W01-358-9219	48
57009223	W01-358-9223	48
57009238	W01-358-9238	58
57009250	W01-358-9250	70
57009275	W01-358-9275	69
57009302	W01-358-9302	Call us
57009321	W01-358-9321	60
57009379	W01-358-9379	27
57009415	W01-358-9415	24
57009421	W01-358-9421	66
57009422	W01-358-9422	19
90023493	WC1-358-0528	Call us
90023494	WC1-358-1634	Call us
90023495	WC1-358-9453	Call us
90023496	WC1-358-9452	Call us
90044197	W01-358-9158	86
90044199	W01-358-9039	34
90044200	W01-358-9082	46
90044201	W01-358-9101	57
90044216	W01-358-9082	46
90044647	W01-358-9082	46

MANUFACTURER/ PART NO.	FIRESTONE ASSEMBLY ORDER NO.	PAGE NO.
90044658	W01-358-9122	85
90044701	W01-358-9101	57
90044702	W01-358-9121	82
90045007	WC1-358-0666	Call us
90045008	WC1-358-1619	Call us
90045009	WC1-358-0664	Call us
90045102	WC1-358-1616	Call us
90054043	W01-358-9122	85
90054060	W01-358-9121	82
90054218	W01-358-9101	57
90054234	W01-358-9039	34
90054540	W01-358-9268	63
90057057	W01-358-5412	14
90554043	W01-358-9122	85
90557001	W01-358-7135	106
90557002	W01-358-7009	96
90557003	W01-358-9177	83
90557005	W01-358-9158	86
90557006	W01-358-9082	46
90557007	W01-358-9093	47
90557008	W01-358-9101	57
90557009	W01-358-9101	57
90557010	W01-358-9121	82
90557011	W01-358-9039	34
90557012	W01-358-9033	34
90557014	W01-358-7424	111
90557015	W01-358-7437	111
90557016	W01-358-7400	109
90557018	W01-358-7400	109
90557019	W01-358-9121	82
90557020	W01-358-9122	85
90557023	W01-358-9039	34
90557024	W01-358-7146	106
90557026	W01-358-7112	98
90557027	W01-358-9082	46
90557028	W01-358-7112	98
90557029	W01-358-8997	19
90557030	W01-358-9075	Call us
90557031	W01-358-9092	46
90557032	W01-358-9093	47

PRIMARY TRUCK & TRAILER, AUXILIARY / TAG AXLE

**MANUFACTURER TO FIRESTONE NUMBER**

MANUFACTURER/ PART NO.	FIRESTONE ASSEMBLY ORDER NO.	PAGE NO.
90557033	W01-358-9082	46
90557034	W01-358-8997	19
90557035	W01-358-9093	47
90557037	W01-358-9082	46
90557038	W01-358-9070	42
90557038	W01-358-9105	38
90557039	W01-358-7146	106
90557043	W01-358-9101	57
90557052	W01-358-9121	82
90557054	W01-358-9082	46
90557069	W01-358-9158	86
90557071	W01-358-9122	85
90557075	W01-358-9082	46
90557076	W01-358-9122	85
90557077	W01-358-9122	85
90557078	W01-358-9121	82
90557082	W01-358-9101	57
90557083	W01-358-9121	82
90557085	W01-358-9039	34
90557086	W01-358-9192	57
90557089	W01-358-9308	34
90557089	W01-358-9314	Call us
90557090	W01-358-9070	42
90557094	W01-358-9599	31
90557097	W01-358-9650	65
90557098	W01-358-8053	91
90557099	W01-358-9320	59
90557101	W01-358-9193	47
90557102	W01-358-5503	86
90557102	W01-358-5511	87
90557103	W01-358-5505	87
90557104	W01-358-9915	88
90557106	W01-358-9929	Call us
90557107	W01-358-9249	68
90557108	W01-358-9192	57
90557109	W01-358-9192	57
90557110	W01-358-9121	82
90557110	W01-358-9141	82
90557111	W01-358-9138	85
90557112	W01-358-9243	58

MANUFACTURER/ PART NO.	FIRESTONE ASSEMBLY ORDER NO.	PAGE NO.
90557113	W01-358-9362	49
90557117	W01-358-9921	51
90557118	W01-358-9923	51
90557119	W01-358-9922	51
90557120	W01-358-9293	32
90557121	W01-358-9295	33
90557122	W01-358-9291	32
90557123	W01-358-9268	63
90557124	W01-358-9304	49
90557125	W01-358-9134	84
90557126	W01-358-9346	59
90557127	W01-358-9294	32
90557129	W01-358-9307	35
90557130	W01-358-9463	Call us
90557131	W01-358-9463	Call us
90557133	W01-358-9896	88
90557134	W01-358-9896	88
90557135	W01-358-9192	57
90557136	W01-358-9192	57
90557138	W01-358-9902	51
90557139	W01-358-9291	32
90557142	W01-358-9942	52
90557143	W01-358-9943	52
90557144	W01-358-9896	88
90557145	W01-358-9470	69
90557146	W01-358-9471	69
90557147	W01-358-9472	69
90557148	W01-358-9896	88
90557149	W01-358-9325	39
90557150	W01-358-8949	32
90557152	W01-358-9473	69
90557155	W01-358-9144	82
90557156	W01-358-9936	52
90557157	W01-358-9935	51
90557158	W01-358-9484	43
90557159	W01-358-9365	39
90557160	W01-358-9366	39
90557161	W01-358-9482	43
90557162	W01-358-8780	84
90557163	W01-358-8779	84

PRIMARY TRUCK &amp; TRAILER, AUXILIARY / TAG AXLE

**MANUFACTURER TO FIRESTONE NUMBER**

MANUFACTURER/ PART NO.	FIRESTONE ASSEMBLY ORDER NO.	PAGE NO.
90557164	W01-358-8778	81
90557167	W01-358-8748	76
90557168	W01-358-8749	76
90557169	W01-358-8903	63
90557170	W01-358-8802	40
90557172	W01-358-9597	31
90557173	W01-358-8201	Call us
90557173	W01-358-8204	36
90557174	W01-358-5776	67
90557177	W01-358-9471	69
90557178	W01-358-9472	69
90557179	W01-358-9473	69
90557181	W01-358-9472	69
90557182	W01-358-9471	69
90557184	W01-358-9484	43
90557185	W01-358-9122	85
90557189	W01-358-8803	40
90557194	W01-358-8803	40
90557200	W01-358-5503	86
90557203	W01-358-6799	117
90557205	W01-358-8781	84
90557206	W01-358-9491	70
90557208	W01-358-9496	50
90557209	W01-358-9218	81
90557210	W01-358-8203	36
90557210	W01-358-9366	39
90557211	W01-358-9470	69
90557211	W01-358-9502	70
90557212	W01-358-9471	69
90557212	W01-358-9501	70
90557213	W01-358-9472	69
90557213	W01-358-9491	70
90557214	W01-358-9471	69
90557214	W01-358-9501	70
90557215	W01-358-9473	69
90557215	W01-358-9504	70
90557216	W01-358-9473	69
90557216	W01-358-9504	70
90557218	W01-358-9891	87
90557219	W01-358-9585	44

MANUFACTURER/ PART NO.	FIRESTONE ASSEMBLY ORDER NO.	PAGE NO.
90557220	W01-358-9587	30
90557221	W01-358-9586	68
90557223	W01-358-8204	36
90557224	W01-358-9584	20
90557225	W01-358-9366	39
90557226	W01-358-7008	96
90557228	W01-358-6890	99
90557229	W01-358-8198	36
90557230	W01-358-8197	36
90557232	W01-358-9578	68
90557235	W01-358-8746	75
90557236	W01-358-8042	127
90557237	W01-358-6943	104
90557240	W01-358-9582	68
90557241	W01-358-9895	Call us
90557243	W01-358-8744	75
90557247	W01-358-9585	44
90557248	W01-358-9587	30
90557249	W01-358-9586	68
90557250	W01-358-9584	20
90557252	W01-358-9649	54
90557256	W01-358-8195	36
90557260	W01-358-8764	Call us
90557270	W01-358-8793	90
90557271	W01-358-8738	77
90557272	W01-358-8737	77
90557275	W01-358-9507	44
90557283	W01-358-8796	85
90557288	W01-358-8748	76
90557289	W01-358-8749	76
90557290	W01-358-8184	19
90557295	W01-358-9971	52
90557300	W01-358-9936	52
90557301	W01-358-9935	51
90557302	W01-358-9972	Call us
90557308	W01-358-8184	19
90557313	W01-358-9507	44
90557323	W01-358-9144	82
90557329	W01-358-9697	44
90557332	W01-358-9974	53

PRIMARY TRUCK &amp; TRAILER, AUXILIARY / TAG AXLE

**MANUFACTURER TO FIRESTONE NUMBER**

MANUFACTURER/ PART NO.	FIRESTONE ASSEMBLY ORDER NO.	PAGE NO.
90557354	W01-358-9855	Call us
90557358	W01-358-9502	70
90557363	W01-358-9807	39
90557369	W01-358-9974	53
90557372	W01-358-9807	39
90557434	W01-358-5530	90
322800010	W01-358-9033	34
2229000200	W01-M58-8775	88
2229000300	W01-M58-6339	86
3228000200	W01-M58-8775	88
3228000300	W01-M58-6339	86
3228210300	W01-M58-6339	86
3229000300	W01-M58-6339	86
3229001101	W01-M58-6339	86
3229001800	W01-M58-6339	86
3229003100	W01-M58-6348	89
8403/102	W01-M58-6339	86
90557006G	W01-358-9082	46
90557011G	W01-358-9039	34
90557019G	W01-358-9121	82
90557020G	W01-358-9122	85
90557029G	W01-358-8997	19
90557034G	W01-358-8997	19
90557037G	W01-358-9082	46
90557038G	W01-358-9070	42
90557075T	W01-358-9082	46
90557076T	W01-358-9122	85
90557082T	W01-358-9101	57
90557083T	W01-358-9121	82
90557085T	W01-358-9039	34
90557130RH	W01-358-9463	Call us
90557131LH	W01-358-9463	Call us
AR11151F	W01-358-9177	83
AR12151F	W01-358-9158	86
AR13151F	W01-358-9082	46
AR13151G	W01-358-9082	46
AR13153F	W01-358-9082	46
AR13153G	W01-358-9082	46
AR13154F	W01-358-9093	47
AR13155G	W01-358-9070	42

MANUFACTURER/ PART NO.	FIRESTONE ASSEMBLY ORDER NO.	PAGE NO.
AR14151F	W01-358-9101	57
AR14151G	W01-358-9101	57
AR15151	W01-358-9033	34
AR15171F	W01-358-9039	34
AR15171G	W01-358-9039	34
AR1520M	W01-358-7146	106
AR1834	W01-358-7112	98
AR21A	W01-358-7135	106
AR741	W01-358-7009	96
AR901	W01-358-9070	42
TC1442	W01-358-7424	111
TC1443A	W01-358-7437	111
TC1444	W01-358-7400	109
XDSPN05360	W01-358-8204	36
<b>SAMRO</b>		
2500008	W01-M58-8775	88
2500009	W01-M58-6339	86
<b>SAURER</b>		
P10754	W01-358-7325	113
P10755	W01-358-7423	111
P10755	W01-358-7424	111
P10755C	W01-358-7344	109
P10784	W01-358-7423	111
P10794	W01-358-7057	119
P10872A	W01-358-6949	101
P20706	W01-358-3406	116
P50732	W01-358-9122	85
P50733	W01-358-9121	82
P50734	W01-358-9039	34
P60733	W01-358-9221	83
<b>SCANIA</b>		
412418	W01-358-9105	38
660251	W01-358-9652	31
670199	W01-358-7400	109
<b>SEATS</b>		
200117	W01-358-8027	121
200175	W01-358-7088	Call us
201642	W01-358-8752	74
<b>SEDDON ATKINSON</b>		
3305939	W02-358-7002	131
3305939 R91	W02-358-7002	131



PRIMARY TRUCK & TRAILER, AUXILIARY / TAG AXLE

**MANUFACTURER TO FIRESTONE NUMBER**

MANUFACTURER/ PART NO.	FIRESTONE ASSEMBLY ORDER NO.	PAGE NO.
<b>SILENT DRIVE</b>		
AS6882	W01-358-6905	100
AS87290	W01-358-8729	76
	W01-358-5429	18
	W01-358-8025	121
<b>SUPERIOR</b>		
	W01-358-7915	123
<b>SUSPENSION DYNAMICS</b>		
55015	W01-358-9249	68
630044	W01-358-9380	Call us
630045	W01-358-9073	29
630158	W01-358-9017	29
630173	W01-358-6900	99
630174	W01-358-6910	100
630194	W01-358-9017	29
630226	W01-358-5730	16
<b>SUSPENSION INC.</b>		
200041	W01-358-9394	59
200042	W01-358-6902	99
200118	W01-358-6944	104
200154	W01-358-9105	38
200177	W01-358-7850	126
200981	W01-358-7405	110
201150	W01-358-9249	68
<b>T.E.C.</b>		
506003	W01-358-9122	85
507505	W01-358-9096	47
505859/01	W01-M58-6339	86
506243/01	W01-M58-8775	88
<b>TERBERG</b>		
21065660	W01-358-7325	113
21067249	W01-358-9401	65
21067978	W01-358-9106	57
<b>TITAN</b>		
91687700000	W01-M58-6339	86
<b>TMC</b>		
6989635	W01-358-9017	29
12TA12	W01-358-9039	34

MANUFACTURER/ PART NO.	FIRESTONE ASSEMBLY ORDER NO.	PAGE NO.
<b>TOYO</b>		
K27102	W01-358-9749	25
TRL200E	W01-358-9421	66
TRL230H36038200	W01-358-9422	19
TRL240393	W01-358-9082	46
TRL250	W01-358-9101	57
TRL270476	W01-358-9122	85
	W02-358-7103	Call us
<b>TRAILERS DE</b>		
73312	W01-358-7185	109
73312B	W01-358-6910	100
<b>TRAILOR</b>		
0036158E	W01-M58-6339	86
650234Y	W01-M58-6339	86
<b>TRUCKSTELL</b>		
63640	W01-358-7808	124
63641	W01-358-7135	106
63644	W01-358-7135	106
63647	W01-358-9101	57
<b>TUTHILL REYCO</b>		
23631-01	W01-358-5523	90
<b>TUTHILL TECHNOLOGY</b>		
1014	W01-358-7818	124
1015	W01-358-7140	106
1218	W01-358-7443	112
1359	W01-358-9083	46
1371	W01-358-6910	100
1613	W01-358-7798	123
1626	W01-358-7136	106
1971	W01-358-5406	13
2112	W01-358-5410	14
2279	W01-358-7118	Call us
2303	WC1-358-9452	Call us
2524	W01-358-7286	122
2577	W01-358-9210	47
2598	W01-358-9214	Call us
2692	W01-358-9211	48
2725	W01-358-7403	110
2726	W01-358-7400	109

PRIMARY TRUCK & TRAILER, AUXILIARY / TAG AXLE

**MANUFACTURER TO FIRESTONE NUMBER**

MANUFACTURER/ PART NO.	FIRESTONE ASSEMBLY ORDER NO.	PAGE NO.
2727	W01-358-9342	50
4848	W01-358-6902	99
5065	W01-358-9105	38
5122	W01-358-2119	12
5235	W01-358-5423	14
5301	W01-358-8977	16
5307	W01-358-5423	14
5385	W01-358-8922	23
5492	W01-358-8922	23
5553	W01-358-8979	17
5691	W01-358-2120	12
6057	W01-358-8965	Call us
6104	W01-358-2120	12
6117	W01-358-5426	17
6250	W01-358-9478	15
6252	W01-358-9049	29
6352	W01-358-6943	104
6389	W01-358-6905	100
6390	W01-358-6944	104
6391	W01-358-7446	112
6392	W01-358-8008	120
6393	W01-358-8018	121
6394	W01-358-9122	85
6396	W01-358-9245	58
6418	W01-358-9082	46
6419	W01-358-7112	98
6420	W01-358-7135	106
6421	W01-358-7424	111
6424	W01-358-9121	82
6425	W01-358-9158	86
6426	W01-358-9177	83
6427	W01-358-9250	70
6428	W01-358-9275	69
6429	W01-358-9421	66
6941	W01-358-9101	57
7025	W01-358-6960	105
7026	W01-358-7855	Call us
7504	W01-358-5323	13
7593	W01-358-8760	80

MANUFACTURER/ PART NO.	FIRESTONE ASSEMBLY ORDER NO.	PAGE NO.
7692	W01-358-8918	Call us
7765	W01-358-5434	15
7831	W01-358-5436	Call us
7901	W01-358-8735	79
8221	W01-358-7996	120
8273	W01-358-9825	90
8609	W01-358-5702	17
9609	W01-358-5702	17
15634	W01-M58-8775	88
15635	W01-M58-6339	86
15698	W01-358-7447	112
15732	W01-M58-7074	62
15765	W01-358-5406	13
16002	W01-358-2119	12
1288201	W01-358-9082	46
1288202	W01-358-9121	82
1288301	W01-358-9101	57
1288302	W01-358-9122	85
1288401	W01-358-9223	48
1290601	W01-358-6927	104
1292801	W01-358-9010	41
1736001	W01-358-9308	34
1736101	W01-358-8900	Call us
1741401	W01-358-8991	37
1763601	W01-358-9349	Call us
1881301	W01-358-7555	117
1998301	W01-358-7557	117
2001801	W01-358-7555	117
2007401	W01-358-9332	Call us
2012401	W01-358-9966	50
2012402	W01-358-9966	50
2012412	W01-358-9966	50
2014201	W01-358-9947	52
2043701	W01-358-9333	35
2077200	W01-358-5775	66
2077301	W01-358-8959	28
2078301	W01-358-5775	66
2096601	W01-358-9474	50
2105401	W01-358-9377	Call us

PRIMARY TRUCK & TRAILER, AUXILIARY / TAG AXLE  
**MANUFACTURER TO FIRESTONE NUMBER**

MANUFACTURER/ PART NO.	FIRESTONE ASSEMBLY ORDER NO.	PAGE NO.
2105501	W01-358-8976	Call us
2159801	W01-358-8964	33
2176701	W01-358-8776	Call us
2224101	W01-358-8932	37
2242501	W01-358-5777	67
2274701	W01-358-8720	75
2283601	W01-358-9691	Call us
2337701	W01-358-8961	33
2343301	W01-358-8740	74
2352101	W01-358-8855	56
2352102	W01-358-8856	56
2363101	W01-358-8050	91
2452001	W01-358-9320	59
2489401	W01-358-9690	Call us
2489402	W01-358-9690	Call us
2539601	W01-358-9560	25
2543701	W01-358-9559	Call us
7059511	W01-358-8636	Call us
70002901	W01-358-8735	79
70019501	W01-358-8735	79
70099901	W01-358-8733	Call us
70178401	W01-358-6886	103
70261401	W01-358-8824	45
70293201	W01-358-6856	98
70418501	W01-358-7897	103
70595101	W01-358-8636	Call us
11332/15664	W01-358-6808	108
1284401B	W01-358-9944	Call us
1288401A	W01-358-9223	48
1288401B	W01-358-9944	Call us
2012401A	W01-358-9966	50
2012401K	W01-358-9966	50
2014201K	W01-358-9947	52
93AR	W01-358-8018	121
<b>UNIT RIG</b>		
1001404	W01-358-7244	115
1016031	W01-358-7294	Call us
1016034	W01-358-9135	82

MANUFACTURER/ PART NO.	FIRESTONE ASSEMBLY ORDER NO.	PAGE NO.
<b>VAN HOOL</b>		
624319610	W01-358-9280	83
<b>VIBERTI</b>		
128147122	W01-M58-6339	86
<b>VOLVO</b>		
2076095	W01-358-7401	109
3130488	W01-358-7400	109
3130489	W01-358-7136	106
3130490	W01-358-9101	57
3130491	W01-358-9082	46
3130492	W01-358-9039	34
3130494	W01-358-9177	83
3130495	W01-358-9213	48
3130496	W01-358-9422	19
3130497	W01-358-9069	42
3130498	W01-358-8050	91
3130499	W01-358-9158	86
3130500	W01-358-9122	85
3130501	W01-358-7135	106
3130502	W01-358-7140	106
3130503	W01-358-9121	82
3130504	W01-358-7424	111
3180673	W01-358-8591	45
3934699	W01-358-8829	72
8061151	W01-358-9296	49
8079902	W01-358-8829	72
8161833	W01-358-9296	49
8169868	W01-358-9296	49
8169869	W01-358-9296	49
20413888	W01-358-8829	72
20505399	W01-358-8829	72
20733034	W01-M58-8463	72
350033201	W01-358-9219	48
350033203	W01-358-9219	48
350033204	W01-358-9219	48

PRIMARY TRUCK & TRAILER, AUXILIARY / TAG AXLE  
**MANUFACTURER TO FIRESTONE NUMBER**

MANUFACTURER/ PART NO.	FIRESTONE ASSEMBLY ORDER NO.	PAGE NO.
350033209	W01-358-9219	48
350034409	W01-358-9466	49
352030005	W01-358-7145	106
352030005	W01-358-7146	106
352035001	W01-358-7403	110
3500033201	W01-358-9219	48
3500033204	W01-358-9219	48
3500033209	W01-358-9219	48
3522233203	W01-358-9219	48
8169868/69	W01-358-9296	49
<b>VSTEER II</b>		
LiftBag	W01-358-6943	104
<b>WABASH (ROADTRAILER)</b>		
	W01-358-8984	92
<b>WATSON &amp; CHALIN</b>		
1R13155	W01-358-8637	77
AS-0039	W01-358-5523	90
AS0001	W01-358-6910	100
AS0002	W01-358-6902	99
AS0003	W01-358-7400	109
AS0004	W01-358-7136	106
AS0005	W01-358-7446	112
AS0006	W01-358-7798	123
AS0007	W01-358-7403	110
AS0008	W01-358-7140	106
AS0009	W01-358-7424	111
AS0011	W01-358-9082	46
AS0012	W01-358-9039	34
AS0013	W01-358-9121	82
AS0014	W01-358-7401	109
AS0015	W01-358-9105	38
AS0017	W01-358-9422	19
AS0019	W01-358-8008	120
AS00191F	W01-358-7994	119

MANUFACTURER/ PART NO.	FIRESTONE ASSEMBLY ORDER NO.	PAGE NO.
AS0020	W01-358-6905	100
AS0021	W01-358-6801	107
AS0023	W01-358-9122	85
AS00231F	W01-358-8792	85
AS0025	W01-358-7818	124
AS0026	W01-358-8997	19
AS0027	W01-358-7443	112
AS0028	W01-358-9083	46
AS0029	W01-358-5410	14
AS0030	W01-358-7325	113
AS0032	W01-358-7782	118
AS0033	W01-358-7839	125
AS0034	W01-358-6808	108
AS0035	W01-358-6908	100
AS0036	W01-358-9321	60
AS00361F	W01-358-9321	60
AS0038	W01-358-9192	57
AS0039	W01-358-8050	91
AS0039	W01-358-8052	91
AS0040	W01-358-9101	57
AS00401F	W01-358-9101	57
AS0041	W01-358-6943	104
AS0042	W01-358-5770	66
AS0043	W01-358-9004	Call us
AS0044	W01-358-9010	41
AS0045	W01-358-7273	115
AS00451F	W01-358-7273	115
AS0046	W01-358-9192	57
AS0047	W01-358-5503	86
AS00471G	W01-358-5514	87
AS0047F	W01-358-5503	86
AS0047GA	W01-358-5514	87
AS0048	W01-358-7990	119
AS0048	W01-358-8032	122
AS00481F	W01-358-7995	119

PRIMARY TRUCK & TRAILER, AUXILIARY / TAG AXLE  
**MANUFACTURER TO FIRESTONE NUMBER**

MANUFACTURER/ PART NO.	FIRESTONE ASSEMBLY ORDER NO.	PAGE NO.
AS00482F	W01-358-7990	119
AS00482G	W01-358-7990	119
AS0049	W01-358-9362	49
AS0050	W01-358-9070	42
AS0053	W01-358-9336	43
AS0054	W01-358-9366	39
AS0056	W01-358-9346	59
AS0057	W01-358-9370	60
AS00571G	W01-358-9370	60
AS0058	W01-358-6897	99
AS00581F	W01-358-6886	103
AS0058S	W01-358-6897	99
AS0060	W01-358-9984	Call us
AS0061	W01-358-9243	58
AS00611F	W01-358-8861	56
AS00611G	W01-358-8861	56
AS0062	W01-358-8927	46
AS0063	W01-358-9915	88
AS0064	W01-358-7792	Call us
AS0068	W01-358-7705	114
AS0069	W01-358-5433	Call us
AS0070	W02-358-7022	Call us
AS0073	W01-358-9218	81
AS0075	W01-358-8018	121
AS0077	W01-358-9069	42
AS0078	W01-358-8052	91
AS0079	W01-358-9985	86
AS0081	W01-358-9985	86
AS0082	W01-358-9200	80
AS0083	W01-358-9228	Call us
AS0084	W01-358-8752	74
AS0084	W01-358-9270	71
AS0086	W01-358-7850	126
AS0087	W01-358-7550	117

MANUFACTURER/ PART NO.	FIRESTONE ASSEMBLY ORDER NO.	PAGE NO.
AS0087	W01-358-7555	117
AS00871F	W01-358-7545	116
AS0088	W01-358-7788	102
AS0088G	W01-358-7788	102
AS0089	W01-358-7557	117
AS0090	W01-358-9921	51
AS0092	W01-358-6883	102
AS0092G	W01-358-6883	102
AS0093	W01-358-7409	110
AS0094	W01-358-8752	74
AS0095	W01-358-9053	38
AS0096	W01-358-9250	70
AS0098	W01-358-8753	74
AS009801F	W01-358-8631	74
AS0099	W01-358-9929	Call us
AS0101	W01-358-9194	47
AS0103	W01-358-7304	124
AS0104	W01-358-9367	60
AS0106	W01-358-5297	18
AS0107F	W01-358-8637	77
AS0109	W01-358-7545	116
AS0110	W01-358-6805	108
AS0110G	W01-358-6805	108
AS0111	W01-358-6817	103
AS0112	W01-358-7472	116
AS0113F	W01-358-8825	45
AS0115G	W01-358-6944	104
AS0116	W01-358-2120	12
AS0117	W01-358-7949	117
AS0119F	W01-358-6945	104
AS0122G	W01-358-6948	105
AS0124F	W01-358-9158	86
AS0127G	W01-358-9373	53
AS0128G	W01-358-8053	91
AS0130	W01-358-9011	Call us

PRIMARY TRUCK & TRAILER, AUXILIARY / TAG AXLE  
**MANUFACTURER TO FIRESTONE NUMBER**

MANUFACTURER/ PART NO.	FIRESTONE ASSEMBLY ORDER NO.	PAGE NO.
AS0136	W01-358-7410	111
AS0137	W01-358-9367	60
AS0139	W01-358-9371	53
AS0140	W01-358-9466	49
AS0141	W01-358-9373	53
AS0142	W01-358-9394	59
AS0143	W01-358-8900	Call us
AS0144	W01-358-8774	90
AS01451G	W01-358-6945	104
AS01461G	W01-358-7795	102
AS01471G	W01-358-9780	72
AS01481G	W01-358-9213	48
AS01491G	W01-358-7008	96
AS01541G	W01-358-7180	108
AS01561G	W01-358-6900	99
AS01561G	W01-358-6910	100
AS0159	W01-358-8774	90
AS01591G	W01-358-8774	90
AS01621G	W01-358-9804	86
AS01631G	W01-358-9243	58
AS01641G	W01-358-9935	51
AS0168G	W01-358-8033	122
AS0169	W01-358-9675	26
AS0170	W01-358-9471	69
AS0171	W01-358-9295	33
AS0173	W01-358-9597	31
AS0182	W01-358-9780	72
AS0183	W01-358-8806	40
AS01881F	W01-358-7180	108
LWLSL1100HLFLTT	W01-358-7839	125
LWLSL1100SSRLW	W01-358-8008	120
LWLSL1100TTHLES	W01-358-7839	125
WCLWSL1100	W01-358-8032	122
WCLWSL1100LW	W01-358-8008	120
	W01-358-9350	59

MANUFACTURER/ PART NO.	FIRESTONE ASSEMBLY ORDER NO.	PAGE NO.
<b>WEWELER</b>		
US87408F	W01-M58-6339	86
US874313F	W01-M58-8775	88
USO7074F	W01-M58-7074	62
USO7337F	W01-M58-8775	88
USO7345F	W01-M58-6339	86
<b>YORK</b>		
785168	W01-M58-8775	88
785170	W01-M58-6339	86







PRIMARY TRUCK & TRAILER, AUXILIARY / TAG AXLE

PRIMARY TRUCK & TRAILER, AUXILIARY / TAG AXLE

**GOODYEAR ASSEMBLY NUMBER TO FIRESTONE**

**GOODYEAR ASSEMBLY NUMBER TO FIRESTONE**

GOODYEAR PART NO.	GOODYEAR BELLOWS NO.	FIRESTONE AON	PAGE NO.
1R14190	566283044	W01-358-8774	90
1R14215		W01-358-9141	82
1R14218	566283021	W01-358-8980	82
1R14244	566283015	W01-358-8050	91
1R14245	566283015	W01-358-8091	89
1R14729		W01-M58-6348	89
1R14857		W01-M58-6339	86
1R8005		W01-358-5405	13
1R8005		W01-358-5710	17
1R8005	566163007	W01-358-5730	16
1R8009		W01-358-5310	12
1R8009		W01-358-5311	12
1R8016		W01-358-5710	17
1R8016	566163007	W01-358-5730	16
1R8020		W01-358-5712	17
1R8021		W01-358-5405	13
1R8025	566163007	W01-358-5730	16
1R8026	566163007	W01-358-5730	16
1R8034		W01-358-5710	17
1R8034	566163007	W01-358-5730	16
1R9003	566183010	W01-358-5406	13
1R9003		W01-358-5712	17
1R9019	566183003	W01-358-2119	12
1R9019	566183003	W01-358-8997	19
1R9038	566183010	W01-358-5406	13
1R9040		W01-358-5405	13
1R9041		W01-358-5310	12
1R9065	566183003	W01-358-2119	12
1R9065	566183003	W01-358-8997	19
1R9070	566183004	W01-358-5410	14
1S12002	566241008	W01-358-8829	72
1S12022	566241008	W01-358-9296	49
1S12027	566241001	W01-358-9287	53
1S12027	566241012	W01-358-9287	53

GOODYEAR PART NO.	GOODYEAR BELLOWS NO.	FIRESTONE AON	PAGE NO.
1S12027	566243077	W01-358-9287	53
1S12029	566241001	W01-358-9297	53
1S12029	566241012	W01-358-9297	53
1S12030	566241001	W01-358-9373	53
1S12030	566241012	W01-358-9373	53
1S12030	566241012	W01-358-9375	54
1S12031	566241001	W01-358-9375	54
1S12033	566241010	W01-358-8829	72
1S12035	566241014	W01-358-8829	72
1S12244	566241000	W01-358-9371	53
1S12245	566241008	W01-358-9296	49
1S4.5107		W02-358-7080	136
1S4.5113		W02-358-7056	140
1S4.5121		W02-358-7035	138
1S4007		W02-358-7001	131
1S4007		W02-358-7002	131
1S4007		W02-358-7031	135
1S4008		W02-358-7010	133
1S4008		W02-358-7012	139
1S4035	ASC087163 (piston)	W02-358-7046	130
1S4035	ASC087163 (piston)	W02-358-7055	134
1S4044	ASC087194 (piston)	W02-358-7001	131
1S4056	ASC087194 (piston)	W02-358-7040	134
1S4058	579087139	W02-358-7086	130
1S4067	ASC087137 (piston)	W02-358-7007	136
1S4123	579087157	W02-358-7046	130
1S4175	ASC087157 (piston)	W02-358-7086	130
1S45121	ASC087157 (piston)	W02-358-7108	142
1S5005	ASC0807005 (piston)	W02-358-7012	139
1S5006	ASC087005 (piston)	W02-358-7014	144
1S5006	ASC087005 (piston)	W02-358-7017	141

GOODYEAR PART NO.	GOODYEAR BELLOWS NO.	FIRESTONE AON	PAGE NO.
1S5006	ASC087005 (piston)	W02-358-7042	140
1S5006	ASC087005 (piston)	W02-358-7044	Call us
1S5038	ASC087194 (piston)	W02-358-7081	145
1S5040	ASC087137 (piston)	W02-358-7087	138
1S5055	ASC0807005 (piston)	W02-358-7017	141
1S5057	579087157	W02-358-7108	142
1S5120	579087194	W02-358-7014	144
1S5120	579087194	W02-358-7017	141
1S5120	579087194	W02-358-7042	140
1S5120	579087194	W02-358-7044	Call us
1S5152	579087219	W02-358-7110	146
1S5157	579087139	W02-358-7064	142
1S5175		W02-358-7205	143
1S5175		W02-358-7215	144
1S5176		W02-358-7206	138
1S5186		W02-358-7036	143
1S6067	ASC087137 (piston)	W02-358-7007	136
2B10226	578923202	W01-358-6927	104
2B10226	578923250	W01-358-7795	102
2B12300	578923309	W01-358-7424	111
2B12304	578923309	W01-358-7344	109
2B12305	578923310	W01-358-7443	112
2B12307	578923309	W01-358-7403	110
2B12309	578923309	W01-358-7400	109
2B12311	578923309	W01-358-7180	108
2B12312	578923309	W01-358-7404	110
2B12313	578923309	W01-358-7405	110
2B12316	578923309	W01-358-7400	109
2B12318	578923309	W01-358-7185	109
2B12319	578923305/309	W01-358-7409	110
2B12320	578923305/309	W01-358-7401	109
2B12320	578923309	W01-358-7437	111

GOODYEAR PART NO.	GOODYEAR BELLOWS NO.	FIRESTONE AON	PAGE NO.
2B12324	578923310/309	W01-358-7447	112
2B12324	578923310/309	W01-358-7790	113
2B12345	578923315	W01-358-7545	116
2B12346	578923315	W01-358-7550	117
2B12402	578923310/309	W01-358-7446	112
2B12406	578923305/309	W01-358-7410	111
2B12406	578923309	W01-358-7410	111
2B12410	578923309	W01-358-7404	110
2B12411	578923309	W01-358-7181	108
2B12412	578923309	W01-358-7183	109
2B12416	578923315	W01-358-7444	112
2B12425	578923309	W01-358-7180	108
2B12427	578923309	W01-358-7429	111
2B12428	578923310	W01-358-7473	112
2B12432	578923309	W01-358-7423	111
2B12433	578923309	W01-358-7403	110
2B12434	578923310	W01-358-7472	116
2B12437	578923309	W01-358-7180	108
2B12440	578923315	W01-358-7550	117
2B12440	578923315	W01-358-7555	117
2B12445	578923309	W01-358-7403	110
2B12446	578923310	W01-358-7444	112
2B12459	578923309	W01-358-7405	110
2B14350	578923353	W01-358-7145	106
2B14351	578923353	W01-358-7146	106
2B14354	578923353	W01-358-7145	106
2B14355	578923353	W01-358-7146	106
2B14356	578923351/353	W01-358-7136	106
2B14359	578923351/353	W01-358-7140	106
2B14359	578923353	W01-358-7782	118
2B14360	578923351/353	W01-358-7135	106
2B14361	578923356	W01-358-6801	107
2B14362		W01-358-6800	107
2B14363	578923356	W01-358-9529	108

PRIMARY TRUCK & TRAILER, AUXILIARY / TAG AXLE  
**GOODYEAR ASSEMBLY NUMBER TO FIRESTONE**

GOODYEAR PART NO.	GOODYEAR BELLOWS NO.	FIRESTONE AON	PAGE NO.
2B14365	578923356	W01-358-6801	107
2B14366	578923353	W01-358-6803	107
2B14367	578923353	W01-358-7123	105
2B14383	578923356	W01-358-7557	117
2B14450		W01-358-6800	107
2B14451	578923356	W01-358-9529	108
2B14452	578923356	W01-358-6801	107
2B14453	578923351	W01-358-7136	106
2B14462	578923356	W01-358-6805	108
2B14464		W01-358-8171	107
2B14470	578923356	W01-358-7782	118
2B14476	578923356	W01-358-6799	117
2B15375		W01-358-6800	107
2B15376	578923356	W01-358-6801	107
2B15377	578923356	W01-358-9529	108
2B15378	578923356	W01-358-9529	108
2B6050		W01-358-7025	119
2B6052		W01-358-7025	119
2B6053		W01-358-7025	119
2B6530		W01-358-7025	119
2B6531		W01-358-7025	119
2B6532		W01-358-7025	119
2B7540	579923525	W01-358-3400	116
2B7541	579923525	W01-358-3400	116
2B7542	579923525	W01-358-3400	116
2B7548		W01-358-7659	114
2B8150	579923530	W01-358-7325	113
2B8153	579923530	W01-358-7325	113
2B8155	578923202	W01-358-6910	100
2B8157	578923202	W01-358-6900	99
2B82152	579923530	W01-358-7325	113
2B8550	579923530	W01-358-7325	113
2B8553	579923530	W01-358-7325	113
2B8554	579923530	W01-358-7325	113

GOODYEAR PART NO.	GOODYEAR BELLOWS NO.	FIRESTONE AON	PAGE NO.
2B9200	578923202	W01-358-6910	100
2B9201	578923202	W01-358-6902	99
2B9201	578923202	W01-358-6935	101
2B9202	578923202	W01-358-6910	100
2B9204	578923202	W01-358-6900	99
2B9206	578923202	W01-358-6905	100
2B9207	578923202	W01-358-6900	99
2B9209	578923200	W01-358-6905	100
2B9210	578923202	W01-358-6908	100
2B9216	578923202	W01-358-6900	99
2B9216	578923202	W01-358-6910	100
2B9218	578923202	W01-358-6927	104
2B9218	578923202	W01-358-6940	101
2B9228	556238325	W01-358-6897	99
2B9229	578923202	W01-358-6897	99
2B9229	556238225	W01-358-6897	99
2B9230	578923202	W01-358-6940	101
2B9239	578923211	W01-358-6902	99
2B9245	578923202	W01-358-7788	102
2B9246	578923211	W01-358-6932	100
2B9246	578923211	W01-358-6944	104
2B9250	578923206	W01-358-6943	104
2B9251	578923206	W01-358-6948	105
2B9252	578923202	W01-358-6941	101
2B9252	578923206	W01-358-6944	104
2B9252	578923208	W01-358-6944	104
2B9253	578923206	W01-358-6945	104
2B9254	578923206	W01-358-6946	104
2B9255	578923206	W01-358-6947	105
2B9258	578923206	W01-358-6947	105
2B9265	578923202	W01-358-6941	101
2B9266	578923206	W01-358-6944	104
2B9280	578923206	W01-358-6941	101
2B9288	578923211	W01-358-6926	100

PRIMARY TRUCK & TRAILER, AUXILIARY / TAG AXLE  
**GOODYEAR ASSEMBLY NUMBER TO FIRESTONE**

GOODYEAR PART NO.	GOODYEAR BELLOWS NO.	FIRESTONE AON	PAGE NO.
2B9352	578923208	W01-358-6944	104
2B9492	578923202	W01-358-6910	100
2B9493	578923202	W01-358-6935	101
2B9494	556238225	W01-358-6897	99
2B9606	578923211	W01-358-6890	99
2B9607	578923208	W01-358-6962	105
3B12300	578933100	W01-358-8008	120
3B12300	578933100	W01-358-8025	121
3B12301	578933100	W01-358-8010	120
3B12301	578933100	W01-358-8030	121
3B12303	578933100	W01-358-8018	121
3B12304	578933100	W01-358-8006	120
3B12310	578933100	W01-358-8027	121
3B12312	578933100	W01-358-8033	122
3B12315	578933100	W01-358-8032	122
3B12319	578933100	W01-358-8032	122
3B12322	578933103	W01-358-8042	127
3B12323	578933103	W01-358-8043	127
3B12324	578933100	W01-358-7990	119
3B12328	578933100	W01-358-7994	119
3B12329	578933100	W01-358-7990	119
3B12329	578933100	W01-358-7995	119
3B12335	578933100	W01-358-7996	120
3B12415	578933105	W01-358-8038	127
3B12416	578933105	W01-358-8039	127
3B14350	578933350	W01-358-7808	124
3B14354	578933351 /350	W01-358-7808	124
3B14356	578933350	W01-358-7798	123
3B14356	578933350	W01-358-7838	Call us
3B14359	578933351/350	W01-358-7818	124
3B14359	578933350	W01-358-7839	125
3B14360	578933351/350	W01-358-7800	123
3B14360	578933350	W01-358-7848	126
3B14364	578933350	W01-358-7843	125

GOODYEAR PART NO.	GOODYEAR BELLOWS NO.	FIRESTONE AON	PAGE NO.
3B14365	578933351/350	W01-358-7846	125
3B14367	578933350	W01-358-7796	123
3B14367	578933350	W01-358-7847	125
3B14370	566338335	W01-358-7850	126
3B14382	556338335	W01-358-7850	126
3B14444	578933350	W01-358-7839	125
3B14450	556338335	W01-358-7845	125
3B14451	556338335	W01-358-7846	125
3B14452	556338335	W01-358-7850	126
3B14453	578933350	W01-358-7838	Call us
3B14456	578933350	W01-358-7839	125
3B14457	556338335	W01-358-7843	125
3B14459	556338335	W01-358-7847	125
3B14464	556338335	W01-358-7862	126













PRIMARY TRUCK &amp; TRAILER, AUXILIARY / TAG AXLE

**CONTITECH ASSEMBLY NUMBER TO FIRESTONE**

CONTITECH BELLOWS NO.	FIRESTONE AON	PAGE NO.
9 10-18.5 P 440	W01-358-9373	53
9 10-18.5 P 451	W01-358-9375	54
9 10-18.5 P 456	W01-358-9648	73
9 10-18.5 P 519	W01-358-9373	53
9 10-18.5 P 520	W01-358-9297	53
9 10-18.5 P 521	W01-358-9371	53
9 10-19 A 358	W01-358-9130	57
9 10-19 A 358	W01-358-9241	58
9 10-19 A 358	W01-358-9394	59
9 10-19 P 315	W01-358-9101	57
9 10-19 P 326	W01-358-9192	57
9 10-19 P 355	W01-358-9203	57
9 10-19 P 356	W01-358-9238	58
9 10-19 P 357	W01-358-9240	58
9 10-19 P 358	W01-358-9394	59
9 10-19 P 384	W01-358-9243	58
9 10-19 P 390	W01-358-9245	58
9 10-19 P 435	W01-358-9265	61
9 10-19 P 438	W01-358-9349	Call us
9 10-19 P 439	W01-358-9348	59
9 10-19 P 470	W01-358-9346	59
9 10-19 P 472	W01-358-8852	56
9 10-19 P 552	W01-358-8855	56
9 10-19 P 946	W01-358-9241	58
9 10-21 A 505	W01-358-9367	60
9 10-21 P 360	W01-358-9320	59
9 10-21 P 361	W01-358-9321	60
9 10-21 P 448	W01-358-9370	60
9 10-21 P 505	W01-358-9367	60
9 10B-17.5 A 323	W01-358-9275	69
9 10B-17.5 P 554	W01-358-9491	70
9 10B-19.5 P 889	W01-358-1191	73
9 10D-21 A 324	W01-358-9250	70
9 10S-16 P 382	W01-358-9780	72
9 9-10 P 538	W01-358-9625	26
9 9-10 P 576	W01-358-9675	26
9 9-10 P 862	W01-358-9618	26
9 9-12 P 314	W01-358-9422	19
9 9-12 P 379	W01-358-9379	27

CONTITECH BELLOWS NO.	FIRESTONE AON	PAGE NO.
9 9-12 P 464	W01-358-8901	20
9 9-12 P 477	W01-358-9376	20
9 9-12 P 479	W01-358-9387	21
9 9-12 P 515	W01-358-9616	20
9 9-12 P 563	W01-358-9448	21
9 9-12 P 705	W01-358-9421	66
9 9-14 A 337	W01-358-9439	24
9 9-14 A 337	W01-358-9441	24
9 9-14 P 517	W01-358-8919	23
9 9-9 P 537	W01-358-9622	26
9 9-9 P 859	W01-358-9541	26
9 9-9 P 859	W01-358-9547	25
9 9-9 P 860	W01-358-9617	25
9 9K-15 P 417	W01-358-9295	33
9 9K-15 P 424	W01-358-9293	32
9 9K-15 P 425	W01-358-9291	32
910105P883	W01-358-9307	35
91012A319	W01-358-9105	38
91012A329	W01-358-9078	38
91012A341	W01-358-9113	Call us
91012A342	W01-358-9118	38
91012A343	W01-358-9302	Call us
91012A488	W01-358-9366	39
91012A543	W01-358-8203	36
91012P483	W01-358-8201	Call us
91012P485	W01-358-8932	37
91012P487	W01-358-9339	39
910135S881	W01-358-8800	71
91014A490	W01-358-9336	43
91014A491	W01-358-9467	43
91014A492	W01-358-9482	43
91014A546	W01-358-8810	41
91014P335	W01-358-9059	42
91014P344	W01-358-9008	Call us
91014P349	W01-358-9071	42
91014P437	W01-358-9463	Call us
91014P489	W01-358-8803	40
91014P494	W01-358-9484	43
91014P577	W01-358-8813	41

PRIMARY TRUCK &amp; TRAILER, AUXILIARY / TAG AXLE

**CONTITECH ASSEMBLY NUMBER TO FIRESTONE**

CONTITECH BELLOWS NO.	FIRESTONE AON	PAGE NO.
91014P718	W01-358-9507	44
91014P882	W01-358-9697	44
91014P905	W01-358-8816	41
91014P906	W01-358-8817	41
91016P351	W01-358-9193	47
91016P392	W01-358-9304	49
91016P498	W01-358-8927	46
91016P500	W01-358-9474	50
91016P547	W01-358-9496	50
91016P549	W01-358-9643	64
910175A802	W01-358-1096	45
910175P406	W01-358-9287	53
910175P430	W01-358-9942	52
910175P440	W01-358-9373	53
910175P440	W01-358-9375	54
910175P451	W01-358-9375	54
910175P452	W01-358-9947	52
910175P456	W01-358-9648	73
910175P475	W01-358-9943	52
910175P519	W01-358-9373	53
910175P520	W01-358-9297	53
910175P521	W01-358-9371	53
910175P550	W01-358-9647	54
910175P551	W01-358-9649	54
910175P571	W01-358-9502	70
910175P574	W01-358-9504	70
910175P731	W01-358-9966	50
910175P732	W01-358-9947	52
910175P733	W01-358-9223	48
910175P779	W01-358-6258	71
910175P831	W01-358-6262	62
910175P904	W01-358-8888	50
910185P440	W01-358-9373	53
910185P550	W01-358-9647	54
910185P551	W01-358-9649	54
910185P935	W01-358-9297	53
910185P939	W01-358-9663	55
910195A801	W01-358-0783	55
91019A358	W01-358-9394	59

CONTITECH BELLOWS NO.	FIRESTONE AON	PAGE NO.
91019A830	W01-358-0783	55
91019P359	W01-358-9350	59
91019P383	W01-358-9394	59
91019P391	W01-358-9362	49
91019P553	W01-358-8856	56
91019P762	W01-358-8861	56
91019P765	W01-358-8842	55
91019P801	W01-358-0783	55
91019P898	W01-358-8864	56
91021P361	W01-358-9321	60
91021P505	W01-358-9367	60
910B175A362	W01-358-9274	68
910B175P733	W01-358-9223	48
910BP16P569	W01-358-9644	61
910BP20P738	W01-358-9646	61
910BP22P739	W01-358-9645	61
910D21A555	W01-358-9269	Call us
910S16A382	W01-358-9780	72
9910P861	W01-358-9541	26
9912A334	W01-358-9075	Call us
9912A464	W01-358-8901	20
9914A517	W01-358-8903	63
9914A517	W01-358-8919	23
9916P568	W01-358-9626	25
99515A455	W01-358-8949	32
99515P417	W01-358-9295	33
999P756	W01-358-9651	65
999S537	W01-358-9622	26
999S860	W01-358-9617	25
99B20P740	W01-358-9621	27
99B22P741	W01-358-9619	28
99K15P423	W01-358-9294	32
FD 120-20 509	W01-358-7325	113
FD 12017 3/4 M8	W01-358-7325	113
FD 200-19 310	W01-358-6902	99
FD 200-19 315	W01-358-6905	100
FD 200-19 320	W01-358-6910	100
FD 200-19 362	W01-358-6908	100
FD 200-19 448	W01-358-6941	101

PRIMARY TRUCK & TRAILER, AUXILIARY / TAG AXLE  
**CONTITECH ASSEMBLY NUMBER TO FIRESTONE**

CONTITECH BELLOWS NO.	FIRESTONE AON	PAGE NO.
FD 200-19 450	W01-358-6940	101
FD 200-19 452	W01-358-6932	100
FD 200-19 499	W01-358-6935	101
FD 200-19 504	W01-358-6926	100
FD 200-19 505	W01-358-6897	99
FD 200-19 510	W01-358-7788	102
FD 200-19 713	W01-358-7795	102
FD 200-25 426	W01-358-6943	104
FD 200-25 427	W01-358-6945	104
FD 200-25 428	W01-358-6947	105
FD 200-25 429	W01-358-6948	105
FD 200-25 453	W01-358-6927	104
FD 200-25 454	W01-358-6944	104
FD 200-25 463	W01-358-6946	104
FD 330-22 313	W01-358-7400	109
FD 330-22 318	W01-358-7403	110
FD 330-22 323	W01-358-7443	112
FD 330-22 327	W01-358-7424	111
FD 330-22 331	W01-358-7410	111
FD 330-22 334	W01-358-7401	109
FD 330-22 334	W01-358-7437	111
FD 330-22 343	W01-358-7429	111
FD 330-22 346	W01-358-7404	110
FD 330-22 363	W01-358-7180	108
FD 330-22 364	W01-358-7405	110
FD 330-22 367	W01-358-7409	110
FD 330-22 368	W01-358-7423	111
FD 330-22 471	W01-358-7183	109
FD 330-22 472	W01-358-7181	108
FD 330-22 500	W01-358-7344	109
FD 330-30 340	W01-358-7447	112
FD 330-30 340	W01-358-7790	113
FD 330-30 369	W01-358-7444	112
FD 330-30 370	W01-358-7446	112
FD 330-30 371	W01-358-7472	116
FD 330-30 372	W01-358-7473	112
FD 331-26 480	W01-358-7555	117
FD 331-26 514	W01-358-7545	116
FD 331-26-541	W01-358-7550	117

CONTITECH BELLOWS NO.	FIRESTONE AON	PAGE NO.
FD 530-22 311	W01-358-7135	106
FD 530-22 316	W01-358-7140	106
FD 530-22 321	W01-358-7136	106
FD 530-22 342	W01-358-7146	106
FD 530-22 345	W01-358-7123	105
FD 530-22 374	W01-358-7145	106
FD 530-30 449	W01-358-6803	107
FD 530-30 451	W01-358-6801	107
FD 530-30 532	W01-358-6805	108
FD 530-35 530	W01-358-7557	117
FD 530-35 543	W01-358-6799	117
FD 530-35 544	W01-358-7782	118
FD11017A	W01-358-7659	114
FD12017509	W01-358-7325	113
FD12017A789	W01-358-7505	114
FD12020715	W01-358-7705	114
FD20019319	W01-358-6900	99
FD20019452	W01-358-7686	101
FD20019499	W01-358-6856	98
FD20019506	W01-358-6949	101
FD20019539	W01-358-6890	99
FD20019724	W01-358-6884	99
FD20022524	W01-358-7795	102
FD20022524	W01-358-7897	103
FD20022529	W01-358-6883	102
FD20022706	W01-358-6886	103
FD20023A709	W01-358-7897	103
FD20025507	W01-358-6960	105
FD20025511	W01-358-6962	105
FD33022366	W01-358-7408	110
FD53030518	W01-358-6800	107
FD53030519	W01-358-6808	108
FD53035545	W01-358-7781	118
FD999P767	W01-358-5789	67
FS 330-11 467	W01-358-6994	96
FS 330-11 468	W01-358-7009	96
FS 330-11 474	W01-358-7008	96
FS 530-14 339	W01-358-7112	98
FS 530-14 442	W01-358-7103	97

PRIMARY TRUCK & TRAILER, AUXILIARY / TAG AXLE  
**CONTITECH ASSEMBLY NUMBER TO FIRESTONE**

CONTITECH BELLOWS NO.	FIRESTONE AON	PAGE NO.
FS 530-14 446	W01-358-7104	97
FS53014515	W01-358-7093	97
FS53014538	W01-358-7094	98
FT 330-29 413	W01-358-8032	122
FT 330-29 431	W01-358-8008	120
FT 330-29 431	W01-358-8025	121
FT 330-29 432	W01-358-8010	120
FT 330-29 432	W01-358-8030	121
FT 330-29 434	W01-358-8018	121
FT 330-29 466	W01-358-8027	121
FT 330-29 503	W01-358-8006	120
FT 330-29 520	W01-358-7996	120
FT 330-29 525	W01-358-8033	122
FT 330-29 546	W01-358-7994	119
FT 330-29 547	W01-358-7990	119
FT 330-29 547	W01-358-7995	119
FT 330-29 554	W01-358-8038	127
FT 530-32 325	W01-358-7818	124
FT 530-32 329	W01-358-7798	123
FT 530-32 333	W01-358-7800	123
FT 530-32 336	W01-358-7808	124
FT 530-35 436	W01-358-7838	Call us
FT 530-35 441	W01-358-7850	126
FT 530-35 455	W01-358-7843	125
FT 530-35 456	W01-358-7846	125
FT 530-35 457	W01-358-7847	125
FT 530-35 534	W01-358-7862	126
FT33029433	W01-358-8016	121
FT33029469	W01-358-8025	121
FT33029494	W01-358-8018	121
FT33029498	W01-358-8030	121
FT53032535	W01-358-7797	123
FT53032536	W01-358-7796	123
FT53035437	W01-358-7839	125
FT53035438	W01-358-7844	Call us
FT53035439	W01-358-7848	126
FT53035521	W01-358-7845	125
FT53035726	W01-358-7872	126
SC29-0046	W02-358-7046	130

CONTITECH BELLOWS NO.	FIRESTONE AON	PAGE NO.
SC29-0086	W02-358-7086	130
SC29-O001	W02-358-7001	131
SC29-O001	W02-358-7002	131
SC29-O001	W02-358-7031	135
SC29-W035	W02-358-7035	138
SC29-W075	W02-358-7075	138
SC29-W087	W02-358-7087	138
SC29-Y036	W02-358-7036	143
SC29-Y064	W02-358-7064	142
SC29-Y108	W02-358-7108	142
SC29B092	W02-358-7092	145
SC29B200	W02-358-7200	146
SC29O100	W02-358-7100	132
SC29O201	W02-358-7201	131
SC29W035	W02-358-7061	139
SC29W085	W02-358-7085	136
SC29Y082	W02-358-7082	143
SC31-W206	W02-358-7206	138
SC31-Y205	W02-358-7205	143
SC31-Y215	W02-358-7215	144
SC31B207	W02-358-7215	144
SC31Y215	W02-358-7215	144
SZ 50-11	W02-358-7002	131
SZ 70-5060 P02	W02-358-7055	134
SZ705052	W02-358-7086	130
SZ705060P02	W02-358-7046	130
SZ705067	W02-358-7001	131
SZ707065P02	W02-358-7035	138
SZ707065P02	W02-358-7108	142
SZ707077	W02-358-7075	138
SZ708077	W02-358-7064	142
SZ708077P02	W02-358-7108	142
SZ708082	W02-358-7082	143
SZ709087	W02-358-7092	145

PRIMARY TRUCK & TRAILER, AUXILIARY / TAG AXLE

**BELLOWS INDEX BY BELLOWS NUMBER**



**1T Bellows Number**

1T15M6  
or  
1T15 Series  
C013582149  
1T spring shown

These tables include 1T and Convoluted bellows numbers. For 1T Reversible style springs, locate the bellows number, typically molded directly underneath the Firestone logo. For styles with a **single 1T number**, such as 1T15M6 or 1T19L, use the chart below.

For bellows with a 1T Series number, followed by a C01xxxxxxx number, use the **1T Bellows Index by C01 Bellows Number** table on page 210.

BELLOWS NUMBER	PAGE NO.
 1T REVERSIBLE SLEEVE	
1T14C1	12-13
1T14C3	13-15
1T14C5	15-16
1T14C6	16-17
1T14C7	17
1T14C8	18
1T14CB1	18-19
1T14CP3	Call us
1T14F2 (Replaced by 1T14C1)	12-13
1T14F4 (Replaced by 1T14C3)	13-15
1T14F8 (Replaced by 1T14C7)	17
1T15A (Replaced by 1T15M0)	33-35
1T15A3 (Replaced by 1T15M2)	36-39
1T15AA3 (Replaced by 1T15LP3)	29-32
1T15AA6 (Replaced by 1T15LP6)	Call us
1T15AB7 (Replaced by 1T15MPW7)	62-63
1T15AE5 (Replaced by 1T15LP5)	32-33
1T15AEZR5	Call us
1T15AF6 (Replaced by 1T15SN6)	64
1T15AG9 (Replaced by 1T15MM9)	61
1T15B (Replaced by 1T15L2)	20-22
1T15B2 (Replaced by 1T15L2 or 1T15S5)	20-22

BELLOWS NUMBER	PAGE NO.
1T15B3 (Replaced by 1T15S6)	Call us
1T15CCR6	19
1T15DR5.5	19
1T15K0 (Replaced by 1T15M0)	33-35
1T15K1 (Replaced by 1T15M6)	45-50
1T15K2 (Replaced by 1T15M9)	55-59
1T15K4 (Replaced by 1T15M4)	40-44
1T15KW(-1) (Replaced by 1T15LA(-1))	25-26
1T15KW0 (Replaced by 1T15LA0)	26
1T15KW1.5 (Replaced by 1T15L1.5)	19-20
1T15L0.5	Call us
1T15L1.5	19-20
1T15L2	20-22
1T15L2.5X (Replaced by 1T15LC2.5)	27
1T15L3	Call us
1T15L4	22-24
1T15L6	25
1T15L8X (Replaced by 1T15M6)	45-50
1T15L9	25
1T15LA(-1)	25-26
1T15LA0	26
1T15LB10	27
1T15LC2.5	27
1T15LC4.5	27-28
1T15LC12	28
1T15LP1	Call us

PRIMARY TRUCK & TRAILER, AUXILIARY / TAG AXLE

**BELLOWS INDEX BY BELLOWS NUMBER**

BELLOWS NUMBER	PAGE NO.
1T15LP1.5	28
1T15LP2	28
1T15LP3	29-32
1T15LP5	32-33
1T15LP6	Call us
1T15M0	33-35
1T15M0.5	35
1T15M2	36-39
1T15M3 (Replaced by 1T15MT3)	63
1T15M4	40-44
1T15M6	45-50
1T15M7 (Replaced by 1T15M7.5)	50-53
1T15M7.5	50-53
1T15M8 (Replaced by 1T15M7.5)	50-53
1T15M9	55-59
1T15M11	59-60
1T15MA4	60
1T15MBTW6	61
1T15MBTW10	61
1T15MBTW12	61
1T15MJ6	Call us
1T15MLW7	61
1T15MM5 (Replaced by 1T15MW6)	64
1T15MM9	61
1T15MMW8.0	62
1T15MN6	62
1T15MN7 (Replaced by 1T15M7.5)	50-53
1T15MP7	Call us
1T15MPW6	62
1T15MPW7	62-63
1T15MR2	63
1T15MT3	63
1T15MT6	64
1T15MT8	Call us
1T15MT9	Call us
1T15MW6	64
1T15MW10 (Replaced by 1T15MM9)	61
1T15S5	Call us

BELLOWS NUMBER	PAGE NO.
1T15S6 (Replaced by 1T15LP3)	29-32
1T15SN3	Call us
1T15SN6	64
1T15T1	65
1T15T2	Call us
1T15TM1	65-66
1T15TQ1	66-68
1T15TQ5	Call us
1T15V1	68
1T15V3	68
1T15V8	68-70
1T15V11	70
1T15VL9 (Replaced by 1T15M2)	36-39
1T15VLT10.5 (Replaced by 1T17CL9.5)	79
1T15VM3.5 (Replaced by 1T15VP4)	71
1T15VM4 (Replaced by 1T15VP4)	71
1T15VM8	Call us
1T15VMR8	71
1T15VMW8	71
1T15VP4	71
1T15X1 (Replaced by 1T15M7.5)	50-53
1T15XBZR7.5	72
1T15XMR7	72-73
1T15XNR5	73
1T15XR9	73
1T15Y1 (Replaced by 1T15TQ1)	66-68
1T15Y5 (Replaced by 1T15TQ5)	Call us
1T15ZR3 (Replaced by 1T15MT3)	63
1T15ZR6 (Replaced by 1T15XBZR7.5)	72
1T17AZR4.5	Call us
1T17B5	74-75
1T17B7	75
1T17B11	75-76
1T17BB2	76
1T17BM6	76
1T17BP4	Call us



PRIMARY TRUCK & TRAILER, AUXILIARY / TAG AXLE

**BELLOWS INDEX BY BELLOWS NUMBER**

BELLOWS NUMBER	PAGE NO.
1T17BP17	76
1T17BV3	77
1T17C3	77
1T17C6	77
1T17C6.5	Call us
1T17C8	77-78
1T17CA3	78
1T17CA5	78
1T17CA6	Call us
1T17CA6.5	78-79
1T17CD3	79
1T17CL5	79
1T17CL9.5	79
1T17DCJ8.5	80
1T17GJ6	80
1T19E1 (Replaced by 1T19L7)	81-84
1T19E2 (Replaced by 1T19L11)	85-86
1T19F3 (Replaced by 1T19L3)	80
1T19F5 (Replaced by 1T19L5)	80-81
1T19F7 (Replaced by 1T19L7)	81-84
1T19F9 (Replaced by 1T19L9)	84-85
1T19F11 (Replaced by 1T19L11)	85-86
1T19F12 (Replaced by 1T19L12)	86-87
1T19F14 (Replaced by 1T19L14)	88
1T19F16 (Replaced by 1T19L16)	88
1T19FC5 (Replaced by 1T19LC5)	89
1T19FC6 (Replaced by 1T19LC6)	89
1T19FC8 (Replaced by 1T19LC8)	89
1T19G8	Call us
1T19J1	Call us
1T19J6 (Replaced by 1T19ZK5.7)	90-91
1T19L3	80
1T19L5	80-81
1T19L7	81-84
1T19L9	84-85
1T19L11	85-86
1T19L12	86-87
1T19L14	88

BELLOWS NUMBER	PAGE NO.
1T19L16	88
1T19LB8	88
1T19LB12	89
1T19LC5	89
1T19LC6	89
1T19LC8	89
1T19LC11	Call us
1T19LE8	90
1T19LE12	90
1T19LF7	90
1T19LG8	90
1T19N9	Call us
1T19ZK5.7	90-91
1T19ZK6.7	Call us
1T26D7	91
1T30E1 (Replaced by 1T19L7)	81-84
1T60BA326	Call us
1T66E11.8 (Replaced by 1T66G11.8)	92
1T66G11.8	92
1T66G19.8	Call us
 SINGLE CONVOLUTED	
16	96
19	96-97
19-.75	97
113	97
113-.5	97
113-1	98
113-1x88-1 (Obsolete No replacement)	Call us
116-1	Call us
126	98
150	98

PRIMARY TRUCK & TRAILER, AUXILIARY / TAG AXLE

**BELLOWS INDEX BY BELLOWS NUMBER**

BELLOWS NUMBER	PAGE NO.
 DOUBLE CONVOLUTED	
20	98-102
20-1	102-103
20-2	103-105
21	105-107
21-2	107-108
22	108-111
22-1.5	112-113
25 (Replaced by 268)	119
26	113-114
28	114
29	115
201	115
203	115
205	115
215	115
218	Call us
224	116
228-1.5	116-117
233-2	117-118
252	Call us
255-1.5 (replaced by 267-1.5)	118
256-2	Call us
257 (replaced by 20)	98-102
257-1 (replaced by 20-1)	102-103
264	118
267-1.5	118
268	119

BELLOWS NUMBER	PAGE NO.
 TRIPLE CONVOLUTED	
38	119-122
39	122
312	122-123
313	123-124
320	124
321	124
323	124
333	125-126
352	126-127
354	127

**1T BELLOWS INDEX BY C01 BELLOWS NUMBER**



**1T Series Number and C01 Number**

1T15M6  
or  
1T15 Series  
C013582149

For 1T Reversible style springs, locate the bellows number, typically molded directly underneath the Firestone logo. For styles with a **1T Series number, followed by a C01 number**, such as C013582149, use the chart below.

For bellows with a single 1T number, such as 1T15M6 or 1T19L, use the **Bellows Index by Bellows Number** table on page 206.

C01 NUMBER	1T SERIES NUMBER	PAGE NO.
C01-358-0007	W01-358-8944	61
C01-358-0018	W01-358-5298	18
C01-358-0018	W01-358-5319	18
C01-358-0018	W01-358-5379	18
C01-358-0018	W01-358-8992	19
C01-358-0018	W01-358-8997	19
C01-358-0018	W01-358-5297	18
C01-358-0054	W01-358-6231	62
C01-358-0054	W01-358-6262	62
C01-358-0082	W01-358-8494	62
C01-358-0093	W01-358-8478	29
C01-358-0093	W01-358-8492	29
C01-358-0093	W01-358-9017	29
C01-358-0093	W01-358-9049	29
C01-358-0093	W01-358-9073	29
C01-358-0093	W01-358-9290	30
C01-358-0093	W01-358-9539	30
C01-358-0093	W01-358-9587	30
C01-358-0093	W01-358-9592	30
C01-358-0093	W01-358-9597	31
C01-358-0093	W01-358-9599	31
C01-358-0093	W01-358-9652	31
C01-358-0093	W01-358-9750	31
C01-358-0093	W01-358-9953	32
C01-358-0093	W01-358-9285	30
C01-358-0093	W01-358-9595	31

C01 NUMBER	1T SERIES NUMBER	PAGE NO.
C01-358-0095	W01-358-8949	32
C01-358-0095	W01-358-9291	32
C01-358-0095	W01-358-9293	32
C01-358-0095	W01-358-9294	32
C01-358-0095	W01-358-9295	33
C01-358-0106	W01-358-8597	28
C01-358-0107	W01-358-8959	28
C01-358-0394	W01-358-8539	80
C01-358-0416	W01-358-8109	77
C01-358-0417	W01-358-8614	78
C01-358-0420	W01-358-8673	76
C01-358-0452	W01-358-9580	79
C01-358-0452	W01-358-9581	79
C01-358-0453	W01-358-8617	79
C01-358-0454	W01-358-8729	76
C01-358-0455	W01-358-8616	77
C01-358-0458	W01-358-8631	74
C01-358-0458	W01-358-8723	74
C01-358-0458	W01-358-8740	74
C01-358-0458	W01-358-8752	74
C01-358-0458	W01-358-8753	74
C01-358-0458	W01-358-8755	75
C01-358-0458	W01-358-8782	75
C01-358-0459	W01-358-8744	75
C01-358-0459	W01-358-8746	75
C01-358-0459	W01-358-8748	76

**BELLOWS INDEX BY BELLOWS NUMBER**

C01 NUMBER	1T SERIES NUMBER	PAGE NO.
C01-358-0459	W01-358-8749	76
C01-358-0463	W01-358-8720	75
C01-358-0466	W01-358-8637	77
C01-358-0467	W01-358-8724	76
C01-358-0469	W01-358-8737	77
C01-358-0469	W01-358-8738	77
C01-358-0470	W01-358-8710	79
C01-358-0471	W01-358-8709	78
C01-358-0473	W01-358-8708	78
C01-358-0473	W01-358-8713	78
C01-358-0473	W01-358-8735	79
C01-358-0495	W01-358-9915	88
C01-358-0496	W01-358-5505	87
C01-358-0496	W01-358-5514	87
C01-358-0497	W01-358-9221	83
C01-358-0501	W01-358-8778	81
C01-358-0501	W01-358-8980	82
C01-358-0501	W01-358-9121	82
C01-358-0501	W01-358-9135	82
C01-358-0501	W01-358-9141	82
C01-358-0501	W01-358-9144	82
C01-358-0501	W01-358-9148	83
C01-358-0501	W01-358-9149	83
C01-358-0501	W01-358-9177	83
C01-358-0501	W01-358-9280	83
C01-358-0501	W01-358-9811	84
C01-358-0504	W01-358-9264	88
C01-358-0513	W01-358-5523	90
C01-358-0513	W01-358-8050	91
C01-358-0513	W01-358-8052	91
C01-358-0513	W01-358-8053	91
C01-358-0517	W01-358-8793	90
C01-358-0519	W01-358-8774	90
C01-358-0521	W01-358-9825	90
C01-358-0522	W01-358-5503	86
C01-358-0522	W01-358-5508	87

C01 NUMBER	1T SERIES NUMBER	PAGE NO.
C01-358-0522	W01-358-5511	87
C01-358-0522	W01-358-9891	87
C01-358-0525	W01-358-8792	85
C01-358-0525	W01-358-9122	85
C01-358-0525	W01-358-9156	85
C01-358-0525	W01-358-9158	86
C01-358-0525	W01-358-9804	86
C01-358-0525	W01-358-9985	86
C01-358-0525	W01-358-8796	85
C01-358-0526	W01-358-8760	80
C01-358-0527	W01-358-9896	88
C01-358-0527	W01-358-9928	88
C01-358-0562	W01-358-5530	90
C01-358-0572	W01-358-9780	72
C01-358-0572	W01-358-9781	72
C01-358-0572	W01-358-9782	72
C01-358-0583 (replaced by C01-358-0572)		72
C01-358-0927	W01-358-8984	92
C01-358-1000	W01-358-0783	55
C01-358-1000	W01-358-8842	55
C01-358-1000	W01-358-8852	56
C01-358-1000	W01-358-8855	56
C01-358-1000	W01-358-8856	56
C01-358-1000	W01-358-8861	56
C01-358-1000	W01-358-8864	56
C01-358-1000	W01-358-9101	57
C01-358-1000	W01-358-9106	57
C01-358-1000	W01-358-9130	57
C01-358-1000	W01-358-9192	57
C01-358-1000	W01-358-9203	57
C01-358-1000	W01-358-9238	58
C01-358-1000	W01-358-9241	58
C01-358-1000	W01-358-9243	58
C01-358-1000	W01-358-9245	58
C01-358-1000	W01-358-9346	59
C01-358-1000	W01-358-9350	59

PRIMARY TRUCK & TRAILER

**1T BELLOWS INDEX BY C01 BELLOWS NUMBER**

CO1 NUMBER	1T SERIES NUMBER	PAGE NO.
C01-358-1000	W01-358-9394	59
C01-358-1000	W01-358-9240	58
C01-358-1000	W01-358-9348	59
C01-358-1008	W01-358-5766	65
C01-358-1008	W01-358-9421	66
C01-358-1008	W01-358-9423	66
C01-358-1013	W01-358-9401	65
C01-358-1013	W01-358-9402	65
C01-358-1013	W01-358-9650	65
C01-358-1013	W01-358-9651	65
C01-358-1016	W01-358-9268	63
C01-358-1030	W01-358-5770	66
C01-358-1030	W01-358-5783	67
C01-358-1030	W01-358-5792	67
C01-358-1031	W01-358-5772	66
C01-358-1031	W01-358-5775	66
C01-358-1031	W01-358-5777	67
C01-358-1031	W01-358-5789	67
C01-358-1039	W01-358-9626	25
C01-358-1048	W01-358-5776	67
C01-358-1048	W01-358-9586	68
C01-358-1069	W01-358-8466	63
C01-358-1069	W01-358-9634	63
C01-358-1069	W01-358-9640	63
C01-358-1078	W01-358-9646	61
C01-358-1079	W01-358-9645	61
C01-358-1081	W01-358-9644	61
C01-358-1131	W01-358-8197	36
C01-358-1131	W01-358-8203	36
C01-358-1131	W01-358-8204	36
C01-358-1131	W01-358-8878	37
C01-358-1131	W01-358-8938	37
C01-358-1131	W01-358-8991	37
C01-358-1131	W01-358-9053	38
C01-358-1131	W01-358-9078	38
C01-358-1131	W01-358-9105	38

CO1 NUMBER	1T SERIES NUMBER	PAGE NO.
C01-358-1131	W01-358-9303	38
C01-358-1131	W01-358-9325	39
C01-358-1131	W01-358-9365	39
C01-358-1131	W01-358-9366	39
C01-358-1131	W01-358-9807	39
C01-358-1131	W01-358-8195	36
C01-358-1131	W01-358-8198	36
C01-358-1131	W01-358-8932	37
C01-358-1131	W01-358-9118	38
C01-358-1131	W01-358-9339	39
C01-358-1150	W01-358-8525	19
C01-358-1169	W01-358-8779	84
C01-358-1169	W01-358-8780	84
C01-358-1169	W01-358-8781	84
C01-358-1169	W01-358-9134	84
C01-358-1169	W01-358-9138	85
C01-358-1178	W01-358-9648	73
C01-358-1179	W01-358-8829	72
C01-358-1179	W01-M58-8463	72
C01-358-1179	W01-M58-8468	73
C01-358-1180	W01-358-1190	73
C01-358-1180	W01-358-1191	73
C01-358-1180	W01-358-1192	73
C01-358-2003	W01-358-9547	25
C01-358-2003	W01-358-9617	25
C01-358-2003	W01-358-9622	26
C01-358-2007	W01-358-9618	26
C01-358-2007	W01-358-9625	26
C01-358-2018	W01-358-9621	27
C01-358-2020	W01-358-9584	20
C01-358-2021	W01-358-9541	26
C01-358-2021	W01-358-9675	26
C01-358-2112	W01-358-2119	12
C01-358-2112	W01-358-2120	12
C01-358-2112	W01-358-2131	12
C01-358-2112	W01-358-5310	12

PRIMARY TRUCK & TRAILER

**BELLOWS INDEX BY BELLOWS NUMBER**

CO1 NUMBER	1T SERIES NUMBER	PAGE NO.
C01-358-2112	W01-358-5311	12
C01-358-2112	W01-358-5323	13
C01-358-2112	W01-358-5343	13
C01-358-2114	W01-358-5335	15
C01-358-2114	W01-358-5336	15
C01-358-2114	W01-358-5345	15
C01-358-2114	W01-358-5354	16
C01-358-2114	W01-358-8868	16
C01-358-2139	W01-358-8961	33
C01-358-2139	W01-358-8964	33
C01-358-2139	W01-358-8971	33
C01-358-2139	W01-358-9031	34
C01-358-2139	W01-358-9033	34
C01-358-2139	W01-358-9036	34
C01-358-2139	W01-358-9308	34
C01-358-2139	W01-358-9334	35
C01-358-2139	W01-358-9333	35
C01-358-2145	W01-358-8802	40
C01-358-2145	W01-358-8803	40
C01-358-2145	W01-358-8805	40
C01-358-2145	W01-358-8806	40
C01-358-2145	W01-358-8810	41
C01-358-2145	W01-358-8813	41
C01-358-2145	W01-358-8816	41
C01-358-2145	W01-358-8817	41
C01-358-2145	W01-358-9010	41
C01-358-2145	W01-358-9056	42
C01-358-2145	W01-358-9059	42
C01-358-2145	W01-358-9069	42
C01-358-2145	W01-358-9070	42
C01-358-2145	W01-358-9071	42
C01-358-2145	W01-358-9335	43
C01-358-2145	W01-358-9336	43
C01-358-2145	W01-358-9482	43
C01-358-2145	W01-358-9484	43
C01-358-2145	W01-358-9507	44

CO1 NUMBER	1T SERIES NUMBER	PAGE NO.
C01-358-2145	W01-358-9697	44
C01-358-2145	W01-358-9797	44
C01-358-2145	W01-358-9978	44
C01-358-2145	W01-358-0742	40
C01-358-2145	W01-358-9467	43
C01-358-2145	W01-358-9585	44
C01-358-2149	W01-358-1096	45
C01-358-2149	W01-358-8824	45
C01-358-2149	W01-358-8924	45
C01-358-2149	W01-358-9026	46
C01-358-2149	W01-358-9082	46
C01-358-2149	W01-358-9083	46
C01-358-2149	W01-358-9092	46
C01-358-2149	W01-358-9093	47
C01-358-2149	W01-358-9096	47
C01-358-2149	W01-358-9194	47
C01-358-2149	W01-358-9210	47
C01-358-2149	W01-358-9213	48
C01-358-2149	W01-358-9219	48
C01-358-2149	W01-358-9223	48
C01-358-2149	W01-358-9227	48
C01-358-2149	W01-358-9296	49
C01-358-2149	W01-358-9304	49
C01-358-2149	W01-358-9362	49
C01-358-2149	W01-358-9392	49
C01-358-2149	W01-358-9466	49
C01-358-2149	W01-358-9474	50
C01-358-2149	W01-358-9966	50
C01-358-2149	W01-358-8591	45
C01-358-2149	W01-358-8825	45
C01-358-2149	W01-358-8927	46
C01-358-2149	W01-358-9193	47
C01-358-2149	W01-358-9211	48
C01-358-2149	W01-358-9496	50
C01-358-2151	W01-358-9039	34
C01-358-2151	W01-358-8963	33

PRIMARY TRUCK & TRAILER

**1T BELLOWS INDEX BY C01 BELLOWS NUMBER**

CO1 NUMBER	1T SERIES NUMBER	PAGE NO.
C01-358-2160	W01-358-9287	53
C01-358-2160	W01-358-9297	53
C01-358-2160	W01-358-9371	53
C01-358-2160	W01-358-9373	53
C01-358-2160	W01-358-9375	54
C01-358-2160	W01-358-9641	54
C01-358-2160	W01-358-9647	54
C01-358-2160	W01-358-9649	54
C01-358-2160	W01-358-9654	54
C01-358-2160	W01-358-9663	55
C01-358-2161	W01-358-9260	64
C01-358-2161	W01-358-9278	64
C01-358-2166	W01-358-9568	28
C01-358-2166	W01-358-9567	27
C01-358-2169	W01-358-8831	64
C01-358-2169	W01-358-9643	64
C01-358-2170	W01-358-9619	28
C01-358-2171	W01-358-9560	25
C01-358-2176	W01-358-8647	22
C01-358-2176	W01-358-8874	23
C01-358-2176	W01-358-8916	23
C01-358-2176	W01-358-8919	23
C01-358-2176	W01-358-8922	23
C01-358-2176	W01-358-8941	23
C01-358-2176	W01-358-9391	24
C01-358-2176	W01-358-9415	24
C01-358-2176	W01-358-9439	24
C01-358-2176	W01-358-9441	24
C01-358-2176	W01-358-9469	24
C01-358-2179	W01-358-9379	27
C01-358-2179	W01-358-9565	27
C01-358-2179	W01-358-9566	27
C01-358-2182	W01-358-8897	20
C01-358-2182	W01-358-8901	20
C01-358-2182	W01-358-9376	20
C01-358-2182	W01-358-9387	21

CO1 NUMBER	1T SERIES NUMBER	PAGE NO.
C01-358-2182	W01-358-9445	21
C01-358-2182	W01-358-9447	21
C01-358-2182	W01-358-9448	21
C01-358-2182	W01-358-9457	21
C01-358-2182	W01-358-9459	22
C01-358-2182	W01-358-9477	22
C01-358-2182	W01-358-9562	22
C01-358-2182	W01-358-9551	22
C01-358-2184	W01-358-9422	19
C01-358-2184	W01-358-9616	20
C01-358-2185	W01-358-5405	13
C01-358-2185	W01-358-5406	13
C01-358-2185	W01-358-5410	14
C01-358-2185	W01-358-5412	14
C01-358-2185	W01-358-5414	14
C01-358-2185	W01-358-5422	14
C01-358-2185	W01-358-5423	14
C01-358-2185	W01-358-5434	15
C01-358-2185	W01-358-9478	15
C01-358-2185	W01-358-5408	13
C01-358-2187	W01-358-5426	17
C01-358-2187	W01-358-5702	17
C01-358-2187	W01-358-5712	17
C01-358-2187	W01-358-5710	17
C01-358-2188	W01-358-5429	18
C01-358-2190	W01-358-9307	35
C01-358-2192	W01-358-5439	16
C01-358-2192	W01-358-5730	16
C01-358-2192	W01-358-8977	16
C01-358-2192	W01-358-8979	17
C01-358-2193	W01-358-8970	35
C01-358-2193	W01-358-9306	35
C01-358-2197	W01-358-8888	50
C01-358-2197	W01-358-9342	50
C01-358-2197	W01-358-9902	51
C01-358-2197	W01-358-9921	51

PRIMARY TRUCK & TRAILER

**BELLOWS INDEX BY BELLOWS NUMBER**

CO1 NUMBER	1T SERIES NUMBER	PAGE NO.
C01-358-2197	W01-358-9922	51
C01-358-2197	W01-358-9923	51
C01-358-2197	W01-358-9935	51
C01-358-2197	W01-358-9936	52
C01-358-2197	W01-358-9947	52
C01-358-2197	W01-358-9971	52
C01-358-2197	W01-358-9974	53
C01-358-2197	W01-358-9943	52
C01-358-2200	W01-358-8828	62
C01-358-2203	W01-358-9265	61
C01-358-2205	W01-358-9299	64
C01-358-2211	W01-358-9749	25
C01-358-2276	W01-358-8184	19
C01-358-5085	W01-358-9865	71
C01-358-5085	W01-358-9866	71
C01-358-5087	W01-358-6258	71
C01-358-5090	W01-358-8800	71
C01-358-5090	W01-358-9270	71
C01-358-5098	W01-358-9578	68
C01-358-5098	W01-358-9582	68
C01-358-5103	W01-358-9249	68
C01-358-5105	W01-358-9274	68
C01-358-5105	W01-358-9275	69
C01-358-5105	W01-358-9470	69
C01-358-5105	W01-358-9471	69
C01-358-5105	W01-358-9472	69
C01-358-5105	W01-358-9473	69
C01-358-5105	W01-358-9491	70
C01-358-5105	W01-358-9501	70
C01-358-5105	W01-358-9504	70
C01-358-5105	W01-358-9502	70
C01-358-5129	W01-358-9320	59
C01-358-5129	W01-358-9321	60
C01-358-5129	W01-358-9367	60
C01-358-5129	W01-358-9370	60
C01-358-5129	W01-358-9368	60

CO1 NUMBER	1T SERIES NUMBER	PAGE NO.
C01-358-5133	W01-358-9250	70
C01-358-5147	W01-358-9310	91
C01-358-5147	W01-358-9327	91
C01-358-5250	W01-358-8092	89
C01-358-5349	W01-358-8091	89
C01-358-5350	W01-358-8093	89
C01-358-5356	W01-358-8500	80
C01-358-5356	W01-358-9200	80
C01-358-5356	W01-358-9206	81
C01-358-5356	W01-358-9215	81
C01-358-5356	W01-358-9218	81
C01-358-5356	W01-358-9801	81
C01-M58-0020	W01-358-8931	37
C01-M58-0032	W01-358-8903	63
C01-M58-0032	W01-M58-7074	62
C01-M58-0475	W01-M58-8712	78
C01-M58-0492	W01-M58-8775	88
C01-M58-0499	W01-M58-6339	86
C01-M58-1163	W01-M58-6348	89
C01-M58-2123	W01-M58-9372	55
C01-M58-2123	W01-M58-9656	55
C01-M58-2197	W01-358-9942	52
C01-M58-2212	W01-358-9554	28
C01-M58-2217	W01-M58-8608	80
C01-M58-2292	W01-M58-9851	60
C01-M58-5346	W01-M58-8798	89

PRIMARY TRUCK & TRAILER, AUXILIARY / TAG AXLE  
**BELLOWS INDEX BY SIZE**

BELLOWS NUMBER	PAGE NO.
 <p>1T REVERSIBLE SLEEVE</p>	
<b>5.31" DIA. BEAD PLATE / 6.60" MOLDED DIA.</b>	
1T26D7	91
<b>6.31" DIA. BEAD PLATE / 6.62" MOLDED DIA.</b>	
1T14C1	12-13
1T14C3	13-15
1T14C5	15-16
1T14C6	16-17
1T14C7	17
1T14C8	18
1T14CB1	18-19
<b>9.00" DIA. BEAD PLATE / 7.37" MOLDED DIA.</b>	
1T15DR5.5	19
<b>9.00" DIA. BEAD PLATE / 7.75" MOLDED DIA.</b>	
1T15SN6	64
1T15T1	65
1T15TM1	65-66
1T15TQ1	66-68
<b>9.00" DIA. BEAD PLATE / 9.12" MOLDED DIA.</b>	
1T15CCR6	19
1T15L1.5	19-20
1T15L2	20-22
1T15L4	22-24
1T15L6	25
1T15L9	25
1T15LA(-1)	25-26
1T15LA0	26
1T15LB10	27
1T15LC2.5	27
1T15LC4.5	27-28

BELLOWS NUMBER	PAGE NO.
1T15LC12	28
1T15LP1.5	28
1T15LP2	28
1T15LP3	29-32
1T15LP5	32-33
1T15LP2	29
1T15LP3	30-32
1T15LP5	33
<b>9.00" DIA. BEAD PLATE / 10.00" MOLDED DIA.</b>	
1T15XR9	73
<b>9.00" DIA. BEAD PLATE / 10.12" MOLDED DIA.</b>	
1T15M0	33-35
1T15M0.5	35
1T15M2	36-39
1T15M4	40-44
1T15M6	45-50
1T15M7.5	50-53
1T15M8	53-55
1T15M9	55-59
1T15M11	59-60
1T15MA4	60
1T15MBTW6	61
1T15MBTW10	61
1T15MBTW12	61
1T15MLW7	61
1T15MM9	61
1T15MMW8.0	62
1T15MN6	62
1T15MPW6	62
1T15MPW7	62-63
1T15MR2	63
1T15MT3	63
1T15MT6	64

PRIMARY TRUCK & TRAILER, AUXILIARY / TAG AXLE  
**BELLOWS INDEX BY SIZE**

BELLOWS NUMBER	PAGE NO.
1T15MW6	64
1T15V1	68
1T15V3	68
1T15V8	68-70
1T15V11	70
1T15VMR8	71
1T15VMW8	71
1T15VP4	71
1T15XMR7	72-73
1T15XNR5	73
<b>9.00" DIA. BEAD PLATE / 10.62" MOLDED DIA.</b>	
1T15XBZR7.5	72
<b>10.12" DIA. BEAD PLATE / 6.60" MOLDED DIA.</b>	
1T17B5	74-75
1T17B7	75
1T17B11	75-76
1T17BB2	76
1T17BM6	76
1T17BP17	76
1T17BV3	77
1T17CA3	78
1T17CL5	79
<b>10.38" DIA. BEAD PLATE / 10.62" MOLDED DIA.</b>	
1T17C3	77
1T17C6	77
1T17C8	77-78
1T17CA5	78
1T17CA6.5	78-79
1T17CD3	79
1T17CL9.5	79
<b>10.38" DIA. BEAD PLATE / 11.41" MOLDED DIA.</b>	
1T17DCJ8.5	80
<b>10.38" DIA. BEAD PLATE / 13.90" MOLDED DIA.</b>	
1T17GJ6	80

BELLOWS NUMBER	PAGE NO.
<b>11.31" DIA. BEAD PLATE / 10.62" MOLDED DIA.</b>	
1T19L3	80
1T19L5	80-81
1T19L7	81-84
1T19L9	84-85
1T19L11	85-86
1T19L12	86-87
1T19L14	88
1T19L16	88
1T19LB8	88
1T19LB12	89
1T19LC5	89
1T19LC6	89
1T19LC8	89
1T19LE8	90
1T19LE12	90
1T19LF7	90
1T19ZK5.7	90-91
1T66G11.8	92
1T19ZK5.7	94-95
1T66G11.8	95

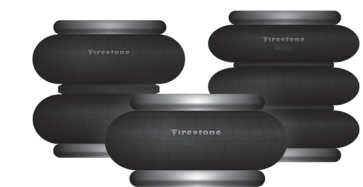

CONVOLUTED  
ON NEXT PAGE



PRIMARY TRUCK & TRAILER

**INDEX BY PISTON COMPONENT NUMBER**

PISTON COMP NO.	PISTON DRAWING NO.	PISTON TYPE	PISTON MATERIALS	PISTON AON	FIRESTONE AON	PAGE NO.
3808	NAD-17160	1T19E1	Aluminum	N/A	W01-M58-8775	88
3808	NAD-37989	1T19E1	Aluminum	N/A	W01-M58-8775	88
3808	NAD-40208	1T19E1	Aluminum	N/A	W01-M58-8775	88
3822	NBD-10378	1T15M2	Aluminum	N/A	W01-358-8931	37
3822	NBD-10378	1T15M2	Aluminum	N/A	W01-358-9391	24
3850	NAD-28198	1T15MP6	Composite	N/A	W01-M58-7074	62
3850	NAD-28198	1T15MP6	Composite	N/A	W01-M58-8608	80
3881	NAD-34837	1T15MP6	Composite	N/A	W01-M58-7074	62
3881	NAD-34837	1T15MP6	Composite	N/A	W01-M58-8608	80
3894	NAD-34318	1T19G5	Aluminum	N/A	W01-M58-8798	89
4008	FIP-101526	1T15MR	Composite	N/A	W01-358-1190	73
4008	FIP-101526	1T15MR	Composite	N/A	W01-358-1191	73
4008	FIP-101526	1T15MR	Composite	N/A	W01-358-1192	73
4008	FIP-101526	1T15MR	Composite	N/A	W01-358-8829	72
4008	FIP-101526	1T15MR	Composite	N/A	W01-358-9648	73
4008	FIP-101526	1T15MR	Composite	N/A	W01-M58-8463	72
4008	FIP-101526	1T15MR	Composite	N/A	W01-M58-8468	73
4034	NAD-37991	1T19E2	Steel	N/A	W01-M58-6348	89
4078	NBD-17119	1T15Y1	Aluminum	N/A	W01-358-5770	66
4078	NBD-17119	1T15Y1	Aluminum	N/A	W01-358-5772	66
4078	NBD-17119	1T15Y1	Aluminum	N/A	W01-358-5775	66
4078	NBD-17119	1T15Y1	Aluminum	N/A	W01-358-5776	67
4078	NBD-17119	1T15Y1	Aluminum	N/A	W01-358-5777	67
4078	NBD-17119	1T15Y1	Aluminum	N/A	W01-358-5783	67
4078	NBD-17119	1T15Y1	Aluminum	N/A	W01-358-5789	67
4078	NBD-17119	1T15Y1	Aluminum	N/A	W01-358-9586	68
4083	NAD-39687	1T15V11	Aluminum	WC1-358-1607	W01-358-9580	79
4083	NAD-39687	1T15V11	Aluminum	WC1-358-1607	W01-358-9581	79
6781	NAD-40125	1T15MP6	Composite	N/A	W01-M58-7074	62
6781	NAD-40125	1T15M	Composite	N/A	W01-M58-7074	62
6836	FIP-103972	1T15M4	Composite	WC1-358-0666	W01-358-9069	42
6845	FIP-103902	1T17B7	Aluminum	WC1-358-1611	W01-358-8710	79
6846	FIP-103901	1T19G9	Aluminum	N/A	W01-358-8793	90
6846	FIP-103901	1T19G9	Aluminum	N/A	W01-358-9825	90
6848	FIP-103899	1T19G5	Aluminum	WC1-358-0631	W01-358-5530	90
6848	FIP-103899	1T19G5	Aluminum	WC1-358-0631	W01-358-8500	80
6848	FIP-103899	1T19G5	Aluminum	WC1-358-0631	W01-358-8760	80
6848	FIP-103899	1T19G5	Aluminum	WC1-358-0631	W01-358-9200	80
6848	FIP-103899	1T19G5	Aluminum	WC1-358-0631	W01-358-9206	81
6848	FIP-103899	1T19G5	Aluminum	WC1-358-0631	W01-358-9215	81

PRIMARY TRUCK & TRAILER

**INDEX BY PISTON COMPONENT NUMBER**

PISTON COMP NO.	PISTON DRAWING NO.	PISTON TYPE	PISTON MATERIALS	PISTON AON	FIRESTONE AON	PAGE NO.
6848	FIP-103899	1T19G5	Aluminum	WC1-358-0631	W01-358-9218	81
6848	FIP-103899	1T19G5	Aluminum	WC1-358-0631	W01-358-9801	81
6848	FIP-103899	1T19G5	Aluminum	WC1-358-0631	W01-358-9811	84
6848	FIP-103899	1T19G5	Aluminum	WC1-358-0631	W01-358-9200	80
6849	FIP-103898	1T15M6	Aluminum	N/A	W01-358-9971	52
6849	FIP-103898	1T15M6	Aluminum	N/A	W01-358-9974	53
6850	FIP-103897	1T15M2	Aluminum	N/A	W01-358-9391	24
6850	NBD-10378	1T15M2	Aluminum	N/A	W01-358-9391	24
6851	FIP-103896	1T15M0	Aluminum	WC1-358-0663	W01-358-9031	34
6851	FIP-103896	1T15M0	Aluminum	WC1-358-0663	W01-358-9036	34
6851	FIP-103896	1T15M0	Aluminum	WC1-358-0663	W01-358-9308	34
6851	FIP-103896	1T15M0	Aluminum	WC1-358-0663	W01-358-9334	35
6851	FIP-103896	1T15M0	Aluminum	WC1-358-0663	W01-358-9650	65
6851	FIP-103897	1T15M3	Aluminum	N/A	W01-358-9391	24
6853	FIP-103894	1T14C1	Aluminum	WC1-358-0600	W01-358-5310	12
6853	FIP-103894	1T14C1	Aluminum	WC1-358-0600	W01-358-5311	12
6853	FIP-103894	1T14C1	Aluminum	WC1-358-0600	W01-358-5323	13
6853	FIP-103894	1T14C1	Aluminum	WC1-358-0600	W01-358-5405	13
6853	FIP-103894	1T14C1	Aluminum	WC1-358-0600	W01-358-5406	13
6853	FIP-103894	1T14C1	Aluminum	WC1-358-0600	W01-358-5408	13
6853	FIP-103894	1T14C1	Aluminum	WC1-358-0600	W01-358-5422	14
6853	FIP-103894	1T14C1	Aluminum	WC1-358-0600	W01-358-5434	15
6853	FIP-103894	1T14C1	Aluminum	WC1-358-0600	W01-358-5712	17
6853	NBD-8626	1T14C1	Aluminum	WC1-358-0600	W01-358-5405	13
6853	NBD-8626	1T14C1	Aluminum	WC1-358-0600	W01-358-5408	13
9461	FIP-101678	1T66	Steel	N/A	W01-358-8984	92
9462	FIP-101776	1T15V7	Composite	N/A	W01-358-9274	68
9462	FIP-101776	1T15V7	Composite	N/A	W01-358-9275	69
9462	FIP-101776	1T15V7	Composite	N/A	W01-358-9467	43
9476	NAD-39639	1T15V11	Aluminum	N/A	W01-M58-8712	78
9477	NAD-39638	1T15V11	Aluminum	WC1-358-1607	W01-358-9580	79
9477	NAD-39638	1T15V11	Aluminum	WC1-358-1607	W01-358-9581	79
9478	FIP-103594	1T15M6	Aluminum	WC1-358-1610	W01-358-8755	75
9482	NAD-36702	1T19E1	Aluminum	WC1-358-9450	W01-358-9135	82
9484	FIP-101468	1T15M6	Composite	WC1-358-1674	W01-358-9978	44
9485	FIP-101705	1T15MR8	Composite	N/A	W01-358-9865	71
9485	FIP-101705	1T15MR8	Composite	N/A	W01-358-9866	71
9488	FIP-101115	1T17C8	Composite	N/A	W01-358-8109	77
9489	FIP-101211	1T15	Composite	WC1-358-1660	W01-358-9807	39
9489	FIP-101361	1T15	Composite	WC1-358-1660	W01-358-9807	39

PRIMARY TRUCK & TRAILER

**INDEX BY PISTON COMPONENT NUMBER**

PISTON COMP NO.	PISTON DRAWING NO.	PISTON TYPE	PISTON MATERIALS	PISTON AON	FIRESTONE AON	PAGE NO.
9490	FIP-101012	1T15M2	Composite	N/A	W01-358-8195	36
9490	FIP-101012	1T15M2	Composite	N/A	W01-358-9469	24
9491	FIP-100744	1T14C1	Composite	N/A	W01-358-2119	12
9491	FIP-100744	1T14C1	Composite	N/A	W01-358-2131	12
9491	FIP-100744	1T14C1	Composite	N/A	W01-358-5297	18
9491	FIP-100744	1T14C1	Composite	N/A	W01-358-5379	18
9491	FIP-100744	1T14C1	Composite	N/A	W01-358-8992	19
9491	FIP-100744	1T14C1	Composite	N/A	W01-358-8997	19
9492	FIP-100742	1T15T0	Composite	N/A	W01-358-5766	65
9492	FIP-100742	1T15T0	Composite	N/A	W01-358-5792	67
9492	FIP-100742	1T15T0	Composite	N/A	W01-358-9401	65
9492	FIP-100742	1T15T0	Composite	N/A	W01-358-9402	65
9492	FIP-100742	1T15T0	Composite	N/A	W01-358-9421	66
9493	FIP-100743	1T14C1	Composite	N/A	W01-358-5298	18
9493	FIP-100743	1T14C1	Composite	N/A	W01-358-5319	18
9493	FIP-100743	1T14C1	Composite	N/A	W01-358-5730	16
9493	FIP-100743	1T14C1	Composite	N/A	W01-358-9478	15
9500	NAD-17855	(replaced by 9544)				
9503	NAD-29826	(replaced by 9544)				
9505	NBD-14537	(replaced by 9492)				
9507	NAD-31763	1T15MP6	Composite	N/A	W01-358-6231	62
9508	NBD-10441	(replaced by 9493)				
9515	NAD-19027	(replaced by 9535)				
9516	NAD-19477	(replaced by 9530)				
9519	NAD-19774	(replaced by 9532)				
9522	NAD-25610	(replaced by 9560)				
9523	NAD-25614	(replaced by 9561)				
9525	NAD-26906	1T17B6	Composite	WC1-358-1609	W01-358-8709	78
9527	NAD-27265	1T15ZR6	Composite	WC1-358-1627	W01-358-9780	72
9528	NAD-29551	1T15V1	Composite	WC1-358-0667	W01-358-8737	77
9528	NBD-14404	1T15V1	Composite	WC1-358-0667	W01-358-8737	77
9528	NBD-14404	1T15V1	Composite	WC1-358-0667	W01-358-8738	77
9528	NBD-14404	1T15V1	Composite	WC1-358-0667	W01-358-8991	37
9528	NBD-14404	1T15V1	Composite	WC1-358-0667	W01-358-9249	68
9528	NBD-14404	1T15V1	Composite	WC1-358-0667	W01-358-9578	68
9528	NBD-14404	1T15V1	Composite	WC1-358-0667	W01-358-9582	68
9530	NAD-27809	1T15M6	Composite	WC1-358-9452	W01-358-0783	55
9530	NAD-27809	1T15M6	Composite	WC1-358-9452	W01-358-8824	45
9530	NAD-27809	1T15M6	Composite	WC1-358-9452	W01-358-8825	45
9530	NAD-27809	1T15M6	Composite	WC1-358-9452	W01-358-8855	56

PRIMARY TRUCK & TRAILER

**INDEX BY PISTON COMPONENT NUMBER**

PISTON COMP NO.	PISTON DRAWING NO.	PISTON TYPE	PISTON MATERIALS	PISTON AON	FIRESTONE AON	PAGE NO.
9530	NAD-27809	1T15M6	Composite	WC1-358-9452	W01-358-8861	56
9530	NAD-27809	1T15M6	Composite	WC1-358-9452	W01-358-8888	50
9530	NAD-27809	1T15M6	Composite	WC1-358-9452	W01-358-8924	45
9530	NAD-27809	1T15M6	Composite	WC1-358-9452	W01-358-8932	37
9530	NAD-27809	1T15M6	Composite	WC1-358-9452	W01-358-9082	46
9530	NAD-27809	1T15M6	Composite	WC1-358-9452	W01-358-9083	46
9530	NAD-27809	1T15M6	Composite	WC1-358-9452	W01-358-9092	46
9530	NAD-27809	1T15M6	Composite	WC1-358-9452	W01-358-9096	47
9530	NAD-27809	1T15M6	Composite	WC1-358-9452	W01-358-9192	57
9530	NAD-27809	1T15M6	Composite	WC1-358-9452	W01-358-9193	47
9530	NAD-27809	1T15M6	Composite	WC1-358-9452	W01-358-9203	57
9530	NAD-27809	1T15M6	Composite	WC1-358-9452	W01-358-9227	48
9530	NAD-27809	1T15M6	Composite	WC1-358-9452	W01-358-9245	58
9530	NAD-27809	1T15M6	Composite	WC1-358-9452	W01-358-9342	50
9530	NAD-27809	1T15M6	Composite	WC1-358-9452	W01-358-9502	70
9530	NAD-27809	1T15M6	Composite	WC1-358-9452	W01-358-9560	25
9531	NAD-29827	1T15MP6	Composite	N/A	W01-358-8864	56
9532	NAD-29827	1T15M6	Composite	WC1-358-1619	W01-358-8494	62
9532	NAD-29827	1T15M6	Composite	WC1-358-1619	W01-358-8746	75
9532	NAD-29827	1T15M6	Composite	WC1-358-1619	W01-358-8748	76
9532	NAD-29827	1T15M6	Composite	WC1-358-1619	W01-358-8803	40
9532	NAD-29827	1T15M6	Composite	WC1-358-1619	W01-358-8842	55
9532	NAD-29827	1T15M6	Composite	WC1-358-1619	W01-358-8852	56
9532	NAD-29827	1T15M6	Composite	WC1-358-1619	W01-358-8856	56
9532	NAD-29827	1T15M6	Composite	WC1-358-1619	W01-358-8903	63
9532	NAD-29827	1T15M6	Composite	WC1-358-1619	W01-358-9026	46
9532	NAD-29827	1T15M6	Composite	WC1-358-1619	W01-358-9194	47
9532	NAD-29827	1T15M6	Composite	WC1-358-1619	W01-358-9243	58
9532	NAD-29827	1T15M6	Composite	WC1-358-1619	W01-358-9295	33
9532	NAD-29827	1T15M6	Composite	WC1-358-1619	W01-358-9325	39
9532	NAD-29827	1T15M6	Composite	WC1-358-1619	W01-358-9362	49
9532	NAD-29827	1T15M6	Composite	WC1-358-1619	W01-358-9470	69
9532	NAD-29827	1T15M6	Composite	WC1-358-1619	W01-358-9496	50
9532	NAD-29827	1T15M6	Composite	WC1-358-1619	W01-358-9621	27
9532	NAD-29827	1T15M6	Composite	WC1-358-1619	W01-358-9626	25
9532	NAD-29827	1T15M6	Composite	WC1-358-1619	W01-358-9644	61
9532	NAD-29827	1T15M6	Composite	WC1-358-1619	W01-358-9646	61
9532	NAD-29827	1T15M6	Composite	WC1-358-1619	W01-358-9697	44
9532	NAD-29827	1T15M6	Composite	WC1-358-1619	W01-358-9923	51
9532	NAD-29827	1T15M6	Composite	WC1-358-1619	W01-358-9935	51



PRIMARY TRUCK & TRAILER  
**INDEX BY PISTON COMPONENT NUMBER**

PISTON COMP NO.	PISTON DRAWING NO.	PISTON TYPE	PISTON MATERIALS	PISTON AON	FIRESTONE AON	PAGE NO.
9532	NAD-29827	1T15M6	Composite	WC1-358-1619	W01-358-9942	52
9533	NAD-30515	1T17BB2	Composite	N/A	W01-358-8617	79
9533	NAD-30515	1T17BB2	Composite	N/A	W01-358-8729	76
9535	NAD-29592	1T15S6	Composite	N/A	W01-358-9260	64
9535	NAD-29592	1T15S6	Composite	N/A	W01-358-9278	64
9537	NAD-29798	1T17B7	Composite	WC1-358-1637	W01-358-8708	78
9537	NAD-29798	1T17B7	Composite	WC1-358-1637	W01-358-8713	78
9538	NAD-27740	1T15M6	Composite	WC1-358-1628	W01-358-8591	45
9538	NAD-27740	1T15M6	Composite	WC1-358-1628	W01-358-9297	53
9538	NAD-27740	1T15M6	Composite	WC1-358-1628	W01-358-9373	53
9538	NAD-27740	1T15M6	Composite	WC1-358-1628	W01-358-9375	54
9538	NAD-27740	1T15M6	Composite	WC1-358-1628	W01-358-9641	54
9538	NAD-27740	1T15M6	Composite	WC1-358-1628	W01-358-9643	64
9538	NAD-27740	1T15M6	Composite	WC1-358-1628	W01-358-9643	64
9538	NAD-27740	1T15M6	Composite	WC1-358-1628	W01-358-9647	54
9538	NAD-27740	1T15M6	Composite	WC1-358-1628	W01-M58-9372	55
9538	NAD-27740	1T15M6	Composite	WC1-358-1628	W01-M58-9656	55
9538	NAD-27740	1T15M6	Composite	WC1-358-1628/ WC1-358-3715	W01-358-9654	54
9538	NAD-27740	1T15M6	Composite	WC1-358-1628/ WC1-358-3715	W01-358-9663	55
9538	NBD-15201	1T15M6	Composite	WC1-358-1628/ WC1-358-3715	W01-358-9654	54
9538	NBD-15201	1T15M6	Composite	WC1-358-1628/ WC1-358-3715	W01-358-9663	55
9540	NAD-29828	1T15M9	Composite	WC1-358-0664	W01-358-8744	75
9540	NAD-29828	1T15M9	Composite	WC1-358-0664	W01-358-8749	76
9540	NAD-29828	1T15M9	Composite	WC1-358-0664	W01-358-9291	32
9540	NAD-29828	1T15M9	Composite	WC1-358-0664	W01-358-9304	49
9540	NAD-29828	1T15M9	Composite	WC1-358-0664	W01-358-9346	59
9540	NAD-29828	1T15M9	Composite	WC1-358-0664	W01-358-9370	60
9540	NAD-29828	1T15M9	Composite	WC1-358-0664	W01-358-9471	69
9540	NAD-29828	1T15M9	Composite	WC1-358-0664	W01-358-9473	69
9540	NAD-29828	1T15M9	Composite	WC1-358-0664	W01-358-9619	28
9540	NAD-29828	1T15M9	Composite	WC1-358-0664	W01-358-9645	61
9540	NAD-29828	1T15M9	Composite	WC1-358-0664	W01-358-9922	51
9540	NAD-29828	1T15M9	Composite	WC1-358-0664	W01-358-9943	52
9541	NAD-25608	(replaced by 9540)				
9544	NAD-29826	1T15M4	Composite	WC1-358-0666	W01-358-8813	41
9544	NAD-29826	1T15M4	Composite	WC1-358-0666	W01-358-8927	46
9544	NAD-29826	1T15M4	Composite	WC1-358-0666	W01-358-9069	42

PRIMARY TRUCK & TRAILER  
**INDEX BY PISTON COMPONENT NUMBER**

PISTON COMP NO.	PISTON DRAWING NO.	PISTON TYPE	PISTON MATERIALS	PISTON AON	FIRESTONE AON	PAGE NO.
9544	NAD-29826	1T15M4	Composite	WC1-358-0666	W01-358-9293	32
9544	NAD-29826	1T15M4	Composite	WC1-358-0666	W01-358-9365	39
9544	NAD-29826	1T15M4	Composite	WC1-358-0666	W01-358-9472	69
9544	NAD-29826	1T15M4	Composite	WC1-358-0666	W01-358-9484	43
9544	NAD-29826	1T15M4	Composite	WC1-358-0666	W01-358-9902	51
9544	NAD-29826	1T15M4	Composite	WC1-358-0666	W01-358-9921	51
9544	NAD-29826	1T15M4	Composite	WC1-358-0666	W01-358-9936	52
9544	NAD-29826	1T15M4	Composite	WC1-358-0666	W01-358-9947	52
9545	NAD-26205	(replaced by 9549)				
9546	NAD-26204	(replaced by 9550)				
9549	NAD-29454	1T15M2	Composite	WC1-358-1616	W01-358-8203	36
9549	NAD-29454	1T15M2	Composite	WC1-358-1616	W01-358-8492	29
9549	NAD-29454	1T15M2	Composite	WC1-358-1616	W01-358-8647	22
9549	NAD-29454	1T15M2	Composite	WC1-358-1616	W01-358-8802	40
9549	NAD-29454	1T15M2	Composite	WC1-358-1616	W01-358-8874	23
9549	NAD-29454	1T15M2	Composite	WC1-358-1616	W01-358-8901	20
9549	NAD-29454	1T15M2	Composite	WC1-358-1616	W01-358-8919	23
9549	NAD-29454	1T15M2	Composite	WC1-358-1616	W01-358-8949	32
9549	NAD-29454	1T15M2	Composite	WC1-358-1616	W01-358-8959	28
9549	NAD-29454	1T15M2	Composite	WC1-358-1616	W01-358-9336	43
9549	NAD-29454	1T15M2	Composite	WC1-358-1616	W01-358-9366	39
9549	NAD-29454	1T15M2	Composite	WC1-358-1616	W01-358-9482	43
9549	NAD-29454	1T15M2	Composite	WC1-358-1616	W01-358-9585	44
9550	NAD-29456	1T15M2	Composite	WC1-358-1652	W01-358-8198	36
9550	NAD-29456	1T15M2	Composite	WC1-358-1652	W01-358-8466	63
9550	NAD-29456	1T15M2	Composite	WC1-358-1652	W01-358-8616	77
9550	NAD-29456	1T15M2	Composite	WC1-358-1652	W01-358-8878	37
9550	NAD-29456	1T15M2	Composite	WC1-358-1652	W01-358-9105	38
9550	NAD-29456	1T15M2	Composite	WC1-358-1652	W01-358-9303	38
9550	NAD-29456	1T15M2	Composite	WC1-358-1652	W01-358-9634	63
9553	NAD-29467	1T15M9	Composite	WC1-358-9453	W01-358-9093	47
9553	NAD-29467	1T15M9	Composite	WC1-358-9453	W01-358-9101	57
9553	NAD-29467	1T15M9	Composite	WC1-358-9453	W01-358-9130	57
9553	NAD-29467	1T15M9	Composite	WC1-358-9453	W01-358-9238	58
9553	NAD-29467	1T15M9	Composite	WC1-358-9453	W01-358-9240	58
9553	NAD-29467	1T15M9	Composite	WC1-358-9453	W01-358-9241	58
9553	NAD-29467	1T15M9	Composite	WC1-358-9453	W01-358-9320	59
9553	NAD-29467	1T15M9	Composite	WC1-358-9453	W01-358-9348	59
9553	NAD-29467	1T15M9	Composite	WC1-358-9453	W01-358-9350	59
9553	NAD-29467	1T15M9	Composite	WC1-358-9453	W01-358-9368	60

PRIMARY TRUCK & TRAILER

**INDEX BY PISTON COMPONENT NUMBER**

PISTON COMP NO.	PISTON DRAWING NO.	PISTON TYPE	PISTON MATERIALS	PISTON AON	FIRESTONE AON	PAGE NO.
9553	NAD-29467	1T15M9	Composite	WC1-358-9453	W01-358-9392	49
9553	NAD-29467	1T15M9	Composite	WC1-358-9453	W01-358-9394	59
9553	NAD-29467	1T15M9	Composite	WC1-358-9453	W01-358-9501	70
9553	NAD-29467	1T15M9	Composite	WC1-358-9453	W01-358-9504	70
9557	NAD-31181	1T15MP6	Composite	N/A	W01-358-6258	71
9557	NAD-31181	1T15MP6	Composite	N/A	W01-358-6262	62
9560	NAD-32768	1T15M6	Composite	WC1-358-1620	W01-358-9213	48
9560	NAD-32768	1T15M6	Composite	WC1-358-1620	W01-358-9219	48
9560	NAD-32768	1T15M6	Composite	WC1-358-1620	W01-358-9296	49
9560	NAD-32768	1T15M6	Composite	WC1-358-1620	W01-358-9371	53
9561	NAD-32767	1T15M6	Composite	WC1-358-1606	W01-358-8831	64
9561	NAD-32767	1T15M6	Composite	WC1-358-1606	W01-358-9287	53
9561	NAD-32767	1T15M6	Composite	WC1-358-1606	W01-358-9466	49
9561	NAD-32767	1T15M6	Composite	WC1-358-1606	W01-358-9649	54
9562	NAD-33610	1T19L9	Composite	N/A	W01-358-8980	82
9562	NAD-33610	1T19L9	Composite	N/A	W01-358-9280	83
9562	NAD-33610	1T19L9	Composite	N/A	W01-358-9985	86
9565	NAD-35451	1T15	Composite	N/A	W01-358-9049	29
9565	NAD-35451	1T15 7	Composite	N/A	W01-358-9285	30
9565	NAD-35451	1T15	Composite	N/A	W01-358-9652	31
9566	NAD-35451	1T15	Composite	N/A	W01-358-9017	29
9566	NAD-35451	1T15	Composite	N/A	W01-358-9073	29
9566	NAD-35451	1T15	Composite	N/A	W01-358-9290	30
9566	NAD-35451	1T15	Composite	N/A	W01-358-9539	30
9566	NAD-35451	1T15	Composite	N/A	W01-358-9592	30
9566	NAD-35451	1T15	Composite	N/A	W01-358-9595	31
9567	NAD-35451	1T15	Aluminum	N/A	W01-358-8478	29
9567	NAD-35451	1T15	Aluminum	N/A	W01-358-9587	30
9567	NAD-35451	1T15	Aluminum	N/A	W01-358-9597	31
9567	NAD-35451	1T15	Aluminum	N/A	W01-358-9599	31
9567	NAD-35451	1T15	Aluminum	N/A	W01-358-9953	32
9569	NAD-27754	1T15KW0	Composite	WC1-358-1629	W01-358-9541	26
9569	NAD-27754	1T15KW0	Composite	WC1-358-1629	W01-358-9547	25
9569	NAD-27754	1T15KW0	Composite	WC1-358-1629	W01-358-9554	28
9569	NAD-27754	1T15KW0	Composite	WC1-358-1629	W01-358-9617	25
9569	NAD-27754	1T15KW0	Composite	WC1-358-1629	W01-358-9618	26
9569	NAD-27754	1T15KW0	Composite	WC1-358-1629	W01-358-9622	26
9569	NAD-27754	1T15KW0	Composite	WC1-358-1629	W01-358-9625	26
9569	NAD-27754	1T15KW0	Composite	WC1-358-1629	W01-358-9675	26
9570	NAD-18162	1T15KW1.5	Composite	N/A	W01-358-8970	35

PRIMARY TRUCK & TRAILER

**INDEX BY PISTON COMPONENT NUMBER**

PISTON COMP NO.	PISTON DRAWING NO.	PISTON TYPE	PISTON MATERIALS	PISTON AON	FIRESTONE AON	PAGE NO.
9570	NAD-18162	1T15KW1.5	Composite	N/A	W01-358-9306	35
9570	NAD-18162	1T15KW1.5	Composite	N/A	W01-358-9584	20
9571	NAD-18130	1T15KW1.5	Composite	WC1-358-0646	W01-358-8897	20
9571	NAD-18130	1T15KW1.5	Composite	WC1-358-0646	W01-358-8964	33
9571	NAD-18130	1T15KW1.5	Composite	WC1-358-0646	W01-358-9376	20
9571	NAD-18130	1T15KW1.5	Composite	WC1-358-0646	W01-358-9422	19
9571	NAD-18130	1T15KW1	Composite	WC1-358-0646	W01-358-9551	22
9571	NAD-18130	1T15KW1.5	Composite	WC1-358-0646	W01-358-9616	20
9571	NAD-18130	1T15KW1.5	Composite	WC1-358-0646	W01-358-9651	65
9572	NAD-18161	1T15KW1.5	Composite	N/A	W01-358-8961	33
9572	NAD-18161	1T15KW1.5	Composite	N/A	W01-358-9562	22
9572	NAD-18161	1T15KW1.5	Composite	N/A	W01-358-9750	31
9573	NAD-18162	1T15KW1.5	Composite	WC1-358-1634	W01-358-8197	36
9573	NAD-18162	1T15KW1.5	Composite	WC1-358-1634	W01-358-8204	36
9573	NAD-18162	1T15KW1.5	Composite	WC1-358-1634	W01-358-8816	41
9573	NAD-18162	1T15KW1.5	Composite	WC1-358-1634	W01-358-8817	41
9573	NAD-18162	1T15KW1.5	Composite	WC1-358-1634	W01-358-8938	37
9573	NAD-18162	1T15KW1	Composite	WC1-358-1634	W01-358-8938	37
9573	NAD-18162	1T15KW1.5	Composite	WC1-358-1634	W01-358-8971	33
9573	NAD-18162	1T15KW1.5	Composite	WC1-358-1634	W01-358-9294	32
9573	NAD-18162	1T15KW1.5	Composite	WC1-358-1634	W01-358-9307	35
9573	NAD-18162	1T15KW1.5	Composite	WC1-358-1634	W01-358-9335	43
9573	NAD-18162	1T15KW1	Composite	WC1-358-1634	W01-358-9339	39
9573	NAD-18162	1T15KW1.5	Composite	WC1-358-1634	W01-358-9387	21
9573	NAD-18162	1T15KW1.5	Composite	WC1-358-1634	W01-M58-9851	60
9574	NAD-38033	1T19E2	Aluminum	N/A	W01-M58-6339	86
9574	NAD-38033	1T19E2	Aluminum	N/A	W01-M58-6348	89
9580	NAD-27909	1T19F11	Composite	WC1-358-0528	W01-358-5503	86
9580	NAD-27909	1T19F11	Composite	WC1-358-0528	W01-358-5511	87
9580	NAD-27909	1T19F11	Composite	WC1-358-0528	W01-358-5514	87
9580	NAD-27909	1T19F11	Composite	WC1-358-0528	W01-358-8781	84
9580	NAD-27909	1T19F11	Composite	WC1-358-0528	W01-358-8796	85
9580	NAD-27909	1T19F11	Composite	WC1-358-0528	W01-358-9122	85
9580	NAD-27909	1T19F11	Composite	WC1-358-0528	W01-358-9156	85
9580	NAD-27909	1T19F11	Composite	WC1-358-0528	W01-358-9158	86
9583	FIP-101543	1T15L-6	Composite	N/A	W01-358-8720	75
9583	FIP-101543	1T15L-6	Composite	N/A	W01-358-9223	48
9585	FIP-101543	1T15L-6	Composite	N/A	W01-358-9749	25
9586	NAD-37432	1T15V5	Aluminum	WC1-358-1613	W01-358-8637	77
9586	NAD-37432	1T15V5	Aluminum	WC1-358-1613	W01-358-8740	74

PRIMARY TRUCK & TRAILER

**INDEX BY PISTON COMPONENT NUMBER**

PISTON COMP NO.	PISTON DRAWING NO.	PISTON TYPE	PISTON MATERIALS	PISTON AON	FIRESTONE AON	PAGE NO.
9586	NAD-37432	1T15V5	Aluminum	WC1-358-1613	W01-358-8752	74
9586	NAD-37432	1T15V5	Aluminum	WC1-358-1613	W01-358-8753	74
9586	NAD-37432	1T15V5	Aluminum	WC1-358-1613	W01-358-9270	71
9587	FIP-101791	1T19ZK5.7	Aluminum	N/A	W01-358-8050	91
9587	FIP-101791	1T19ZK5.7	Aluminum	N/A	W01-358-8050	91
9594	NAD-28384	1T19LC5	Composite	WC1-358-1614	W01-358-8091	89
9594	NAD-28384	1T19LC5	Composite	WC1-358-1614	W01-358-8093	89
9594	NAD-28384	1T19LC5	Composite	WC1-358-1614	W01-358-8539	80
9594	NAD-28384	1T19LC5	Composite	WC1-358-1614	W01-358-8774	90
9601 (replaced by 9527)						
9602	NAD-28351	1T15V5	Aluminum	WC1-358-1613	W01-358-8637	77
9602	NAD-28351	1T15V5	Aluminum	WC1-358-1613	W01-358-8740	74
9602	NAD-28351	1T15V5	Aluminum	WC1-358-1613	W01-358-8752	74
9602	NAD-28351	1T15V5	Aluminum	WC1-358-1613	W01-358-8753	74
9602	NAD-28351	1T15V5	Aluminum	WC1-358-1613	W01-358-9270	71
9603	NAD-29630	1T15V5	Aluminum	WC1-358-1635	W01-358-8723	74
9603	NAD-29630	1T15V5	Aluminum	WC1-358-1635	W01-358-8735	79
9603	NAD-29630	1T15V5	Aluminum	WC1-358-1635	W01-358-8782	75
9603	NAD-29630	1T15V5	Aluminum	WC1-358-1635	W01-358-8828	62
9604	NAD-30174	1T15ZR6	Aluminum	WC1-358-1624	W01-358-9781	72
9606	NAD-35550	1T15M2	Aluminum	N/A	W01-358-1096	45
9606	NAD-35550	1T15M2	Aluminum	N/A	W01-358-8806	40
9606	NAD-35550	1T15M2	Aluminum	N/A	W01-358-8810	41
9606	NAD-35550	1T15M2	Aluminum	N/A	W01-358-9053	38
9606	NAD-35550	1T15M2	Aluminum	N/A	W01-358-9070	42
9606	NAD-35550	1T15M2	Aluminum	N/A	W01-358-9118	38
9606	NAD-35550	1T15M2	Aluminum	N/A	W01-358-9439	24
9606	NAD-35550	1T15M2	Aluminum	N/A	W01-358-9441	24
9606	NAD-35550	1T15M2	Aluminum	N/A	W01-358-9797	44
9606	NAD-35550	1T15M2	Composite	WC1-358-1652	W01-358-9105	38
9607	NAD-35551	1T19E1	Aluminum	WC1-358-9450	W01-358-8778	81
9607	NAD-35551	1T19E1	Aluminum	WC1-358-9450	W01-358-8779	84
9607	NAD-35551	1T19E1	Aluminum	WC1-358-9450	W01-358-8780	84
9607	NAD-35551	1T19E1	Aluminum	WC1-358-9450	W01-358-9121	82
9607	NAD-35551	1T19E1	Aluminum	WC1-358-9450	W01-358-9134	84
9607	NAD-35551	1T19E1	Aluminum	WC1-358-9450	W01-358-9135	82
9607	NAD-35551	1T19E1	Aluminum	WC1-358-9450	W01-358-9138	85
9607	NAD-35551	1T19E1	Aluminum	WC1-358-9450	W01-358-9141	82
9607	NAD-35551	1T19E1	Aluminum	WC1-358-9450	W01-358-9144	82
9607	NAD-35551	1T19E1	Aluminum	WC1-358-9450	W01-358-9148	83

PRIMARY TRUCK & TRAILER

**INDEX BY PISTON COMPONENT NUMBER**

PISTON COMP NO.	PISTON DRAWING NO.	PISTON TYPE	PISTON MATERIALS	PISTON AON	FIRESTONE AON	PAGE NO.
9607	NAD-35551	1T19E1	Aluminum	WC1-358-9450	W01-358-9149	83
9607	NAD-35551	1T19E1	Aluminum	WC1-358-9450	W01-358-9177	83
9607	NAD-35551	1T19E1	Aluminum	WC1-358-9450	W01-358-9221	83
9607	NAD-35551	1T19E1	Aluminum	WC1-358-9450	W01-358-9804	86
9612	NAD-38338	1T19E2	Aluminum	N/A	W01-358-8792	85
9612	NAD-38338	1T19F11	Composite	WC1-358-0528	W01-358-9122	85
9612	NAD-38338	1T19E2	Composite	WC1-358-0528	W01-358-9122	85
9614	NAD-39259	1T15ZR6	Aluminum	WC1-358-1624	W01-358-9781	72
9616	FIP-103585	1T15V5	Aluminum	WC1-358-1635	W01-358-8723	74
9616	FIP-103585	1T15V5	Aluminum	WC1-358-1635	W01-358-8735	79
9616	FIP-103585	1T15V5	Aluminum	WC1-358-1635	W01-358-8782	75
9616	FIP-103585	1T15V5	Aluminum	WC1-358-1635	W01-358-8828	62
9617	FIP-103589	1T14C3	Aluminum	WC1-358-9095	W01-358-5343	13
9617	FIP-103589	1T14C3	Aluminum	WC1-358-9095	W01-358-5354	16
9617	FIP-103589	1T14C3	Aluminum	WC1-358-9095	W01-358-5423	14
9617	FIP-103589	1T14C3	Aluminum	WC1-358-9095	W01-358-8868	16
9618	FIP-103583	1T15MM9	Aluminum	WC1-358-1694	W01-358-8944	61
9618	FIP-103583	1T15MM9	Aluminum	WC1-358-1694	W01-358-9265	61
9618	FIP-103583	1T15MM9	Aluminum	WC1-358-1694	W01-358-9299	64
9620	FIP-103587	1T14F4	Aluminum	N/A	W01-358-5335	15
9620	FIP-103587	1T14F4	Aluminum	N/A	W01-358-5336	15
9620	FIP-103587	1T14F4	Aluminum	N/A	W01-358-5345	15
9620	FIP-103587	1T14F4	Aluminum	N/A	W01-358-5410	14
9620	FIP-103587	1T14F4	Aluminum	N/A	W01-358-5412	14
9620	FIP-103587	1T14F4	Aluminum	N/A	W01-358-5414	14
9620	FIP-103587	1T14F4	Aluminum	N/A	W01-358-5426	17
9621	FIP-103588	1T15M4	Aluminum	WC1-358-0651	W01-358-8805	40
9621	FIP-103588	1T15M4	Aluminum	WC1-358-0651	W01-358-9010	41
9621	FIP-103588	1T15M4	Aluminum	WC1-358-0651	W01-358-9056	42
9621	FIP-103588	1T15M4	Aluminum	WC1-358-0651	W01-358-9059	42
9621	FIP-103588	1T15M4	Aluminum	WC1-358-0651	W01-358-9071	42
9621	FIP-103588	1T15M4	Aluminum	WC1-358-0651	W01-358-9474	50
9621	FIP-103588	1T15M4	Aluminum	WC1-358-0651	W01-358-9491	70
9621	FIP-103588	1T15M4	Aluminum	WC1-358-0651	W01-358-9507	44
9622	FIP-103584	1T15M2	Aluminum	WC1-358-1608	W01-358-9640	63
9639	NAD-37120	1T15DR	Steel	N/A	W01-358-8525	19
9640	FIP-101136	1T19ZK5.7	Aluminum	N/A	W01-358-8050	91
9644	NAD-31862	1T19ZR6.2	Steel	WC1-358-9999	W01-358-5523	90
9644	NAD-31862	1T19ZR6.2	Steel	WC1-358-9999	W01-358-8052	91
9644	NAD-31862	1T19ZR6.2	Steel	WC1-358-9999	W01-358-8053	91

PRIMARY TRUCK & TRAILER

**INDEX BY PISTON COMPONENT NUMBER**

PISTON COMP NO.	PISTON DRAWING NO.	PISTON TYPE	PISTON MATERIALS	PISTON AON	FIRESTONE AON	PAGE NO.
9645	NAD-31622	1T15CCR6	Steel	N/A	W01-358-8184	19
9646	NAD-31215	1T17B17	Steel	N/A	W01-358-8724	76
9648	NAD-31288	1T17B4	Steel	WC1-358-1649	W01-358-8614	78
9648	NAD-31288	1T17B4	Steel	WC1-358-1649	W01-358-8631	74
9648	NAD-31288	1T17B4	Steel	WC1-358-1649	W01-358-8800	71
9651	NBD-11498	1T14C3	Aluminum	WC1-358-9095	W01-358-2120	12
9651	NBD-11498	1T14C3	Aluminum	WC1-358-9095	W01-358-5343	13
9651	NBD-11498	1T14C3	Aluminum	WC1-358-9095	W01-358-5354	16
9651	NBD-11498	1T14C3	Aluminum	WC1-358-9095	W01-358-5423	14
9651	NBD-11498	1T14C3	Aluminum	WC1-358-9095	W01-358-8868	16
9652	NBD-10436	1T15M6	Aluminum	N/A	W01-358-9971	52
9652	NBD-10436	1T15M6	Aluminum	N/A	W01-358-9974	53
9652	NDD-3581	1T15M6	Aluminum	N/A	W01-358-9974	53
9652	NBD-10436	(replaced by 9530)				
9653	NBD-10437	1T15M9	Aluminum	WC1-358-0620	W01-358-9106	57
9653	NBD-10437	1T15M9	Aluminum	WC1-358-0620	W01-358-9321	60
9653	NBD-10437	1T15M9	Aluminum	WC1-358-0620	W01-358-9367	60
9653	NBD-12639	(replaced by 9553)				
9654	NBD-10438	1T15M0	Aluminum	WC1-358-0663	W01-358-9031	34
9654	NBD-10438	1T15M0	Aluminum	WC1-358-0663	W01-358-9036	34
9654	NBD-10438	1T15M0	Aluminum	WC1-358-0663	W01-358-9308	34
9654	NBD-10438	1T15M0	Aluminum	WC1-358-0663	W01-358-9333	35
9654	NBD-10438	1T15M0	Aluminum	WC1-358-0663	W01-358-9334	35
9654	NBD-10438	1T15M0	Aluminum	WC1-358-0663	W01-358-9650	65
9655	NBD-10439	1T15M0	Aluminum	WC1-358-9454	W01-358-8963	33
9655	NBD-10439	1T15M0	Aluminum	WC1-358-9454	W01-358-9033	34
9655	NBD-10439	1T15M0	Aluminum	WC1-358-9454	W01-358-9039	34
9655	NBD-10439	1T15M0	Aluminum	WC1-358-9454	W01-358-9423	66
9656	NAD-35550	1T15M2	Aluminum	N/A	W01-358-9118	38
9656	NBD-10440	1T15M2	Aluminum	N/A	W01-358-1096	45
9656	NBD-10440	1T15M2	Aluminum	N/A	W01-358-8806	40
9656	NBD-10440	1T15M2	Aluminum	N/A	W01-358-8810	41
9656	NBD-10440	1T15M2	Aluminum	N/A	W01-358-9053	38
9656	NBD-10440	1T15M2	Aluminum	N/A	W01-358-9070	42
9656	NBD-10440	1T15M2	Aluminum	N/A	W01-358-9118	38
9656	NBD-10440	1T15M2	Aluminum	N/A	W01-358-9439	24
9656	NBD-10440	1T15M2	Aluminum	N/A	W01-358-9441	24
9656	NBD-10440	1T15M2	Aluminum	N/A	W01-358-9797	44
9657	NAD-18101	1T19E1	Aluminum	WC1-358-9450	W01-358-8778	81
9657	NAD-18101	1T19E1	Aluminum	WC1-358-9450	W01-358-8780	84

PRIMARY TRUCK & TRAILER

**INDEX BY PISTON COMPONENT NUMBER**

PISTON COMP NO.	PISTON DRAWING NO.	PISTON TYPE	PISTON MATERIALS	PISTON AON	FIRESTONE AON	PAGE NO.
9657	NAD-18101	1T19E1	Aluminum	WC1-358-9450	W01-358-9121	82
9657	NAD-18101	1T19E1	Aluminum	WC1-358-9450	W01-358-9134	84
9657	NAD-18101	1T19E1	Aluminum	WC1-358-9450	W01-358-9138	85
9657	NAD-18101	1T19E1	Aluminum	WC1-358-9450	W01-358-9141	82
9657	NAD-18101	1T19E1	Aluminum	WC1-358-9450	W01-358-9144	82
9657	NAD-18101	1T19E1	Aluminum	WC1-358-9450	W01-358-9148	83
9657	NAD-18101	1T19E1	Aluminum	WC1-358-9450	W01-358-9149	83
9657	NAD-18101	1T19E1	Aluminum	WC1-358-9450	W01-358-9177	83
9657	NAD-18101	1T19E1	Aluminum	WC1-358-9450	W01-358-9221	83
9657	NAD-18101	1T19E1	Aluminum	WC1-358-9450	W01-358-9804	86
9658	NAD-18102	1T19E2	Aluminum	N/A	W01-358-8792	85
9658	NAD-18102	(replaced by 9580)				
9659	NBD-10472	1T15T3	Aluminum	N/A	W01-358-8597	28
9659	NBD-10472	1T15T3	Aluminum	N/A	W01-358-8916	23
9659	NBD-10472	1T15T3	Aluminum	N/A	W01-358-8922	23
9659	NBD-10472	1T15T3	Aluminum	N/A	W01-358-8941	23
9659	NBD-10472	1T15T3	Aluminum	N/A	W01-358-9445	21
9659	NBD-10472	1T15T3	Aluminum	N/A	W01-358-9447	21
9659	NBD-10472	1T15T3	Aluminum	N/A	W01-358-9448	21
9659	NBD-10472	1T15T3	Aluminum	N/A	W01-358-9457	21
9659	NBD-10472	1T15T3	Aluminum	N/A	W01-358-9459	22
9659	NBD-10472	1T15T3	Aluminum	N/A	W01-358-9477	22
9663	NBD-12639	1T15L2	Aluminum	N/A	W01-358-9379	27
9663	NBD-12639	1T15	Aluminum	N/A	W01-358-9565	27
9663	NBD-12639	1T15 2	Aluminum	N/A	W01-358-9566	27
9663	NBD-12639	1T15 2	Aluminum	N/A	W01-358-9567	27
9663	NBD-12639	1T15	Aluminum	N/A	W01-358-9568	28
9666	NAD-19631	1T19G9	Aluminum	N/A	W01-358-8793	90
9666	NAD-19631	1T19G9	Aluminum	N/A	W01-358-9825	90
9668	NAD-18727	(replaced by 9669)				
9669	NAD-26291	1T19F12	Aluminum	WC1-358-1602	W01-358-5505	87
9669	NAD-26291	1T19F12	Aluminum	WC1-358-1602	W01-358-5508	87
9669	NAD-26291	1T19F12	Aluminum	WC1-358-1602	W01-358-9264	88
9669	NAD-26291	1T19F12	Aluminum	WC1-358-1602	W01-358-9891	87
9669	NAD-26291	1T19F12	Aluminum	WC1-358-1602	W01-358-9896	88
9669	NAD-26291	1T19F12	Aluminum	WC1-358-1602	W01-358-9915	88
9669	NAD-26291	1T19F12	Aluminum	WC1-358-1602	W01-358-9928	88
9676	NAD-31612	1T15ZR6	Steel	N/A	W01-358-9782	72
9680	NBD-10444	(replaced by 9681)				
9681	NBD-14213	1T15Y1	Aluminum	N/A	W01-358-5770	66

PRIMARY TRUCK & TRAILER

**INDEX BY PISTON COMPONENT NUMBER**

PISTON COMP NO.	PISTON DRAWING NO.	PISTON TYPE	PISTON MATERIALS	PISTON AON	FIRESTONE AON	PAGE NO.
9681	NBD-14213	1T15Y1	Aluminum	N/A	W01-358-5772	66
9681	NBD-14213	1T15Y1	Aluminum	N/A	W01-358-5775	66
9681	NBD-14213	1T15Y1	Aluminum	N/A	W01-358-5776	67
9681	NBD-14213	1T15Y1	Aluminum	N/A	W01-358-5777	67
9681	NBD-14213	1T15Y1	Aluminum	N/A	W01-358-5783	67
9681	NBD-14213	1T15Y1	Aluminum	N/A	W01-358-5789	67
9681	NBD-14213	1T15Y1	Aluminum	N/A	W01-358-9586	68
9686	NAD-28449	(replaced by 9646)				
9691	NBD-14503	1T15L4	Aluminum	N/A	W01-358-9415	24
9694	NAD-25396	1T15MM9	Aluminum	WC1-358-1694	W01-358-8944	61
9694	NAD-25396	1T15MM9	Aluminum	WC1-358-1694	W01-358-9265	61
9694	NAD-25396	1T15MM9	Aluminum	WC1-358-1694	W01-358-9299	64
9699	NAD-33165	1T17BM6	Aluminum	N/A	W01-358-8673	76
9702	NAD-27357	1T15M2	Aluminum	WC1-358-1608	W01-358-9640	63
9708	NBD-8626	1T14C1	Aluminum	WC1-358-0600	W01-358-5310	12
9708	NBD-8626	1T14C1	Aluminum	WC1-358-0600	W01-358-5311	12
9708	NBD-8626	1T14C1	Aluminum	WC1-358-0600	W01-358-5323	13
9708	NBD-8626	1T14C1	Aluminum	WC1-358-0600	W01-358-5405	13
9708	NBD-8626	1T14C1	Aluminum	WC1-358-0600	W01-358-5406	13
9708	NBD-8626	1T14C1	Aluminum	WC1-358-0600	W01-358-5408	13
9708	NBD-8626	1T14C1	Aluminum	WC1-358-0600	W01-358-5422	14
9708	NBD-8626	1T14C1	Aluminum	WC1-358-0600	W01-358-5434	15
9708	NBD-8626	1T14C1	Aluminum	WC1-358-0600	W01-358-5710	17
9708	NBD-8626	1T14C1	Aluminum	WC1-358-0600	W01-358-5712	17
9727	NBD-8724	1T15M4	Aluminum	WC1-358-0651	W01-358-8805	40
9727	NBD-8724	1T15M4	Aluminum	WC1-358-0651	W01-358-9010	41
9727	NBD-8724	1T15M4	Aluminum	WC1-358-0651	W01-358-9056	42
9727	NBD-8724	1T15M4	Aluminum	WC1-358-0651	W01-358-9059	42
9727	NBD-8724	1T15M4	Aluminum	WC1-358-0651	W01-358-9071	42
9727	NBD-8724	1T15M4	Aluminum	WC1-358-0651	W01-358-9474	50
9727	NBD-8724	1T15M4	Aluminum	WC1-358-0651	W01-358-9491	70
9727	NBD-8724	1T15M4	Aluminum	WC1-358-0651	W01-358-9507	44
9734	NAD-28002	1T15M6	Aluminum	WC1-358-1610	W01-358-8755	75
9742	NBD-8055	1T15M2	Aluminum	N/A	W01-358-9078	38
9753	NAD-16485	1T19E2	Aluminum	N/A	W01-M58-6339	86
9754	NBD-11689	1T14C7	Aluminum	WC1-358-1603	W01-358-5429	18
9754	NBD-11689	1T14C7	Aluminum	WC1-358-1603	W01-358-5439	16
9754	NBD-11689	1T14C7	Aluminum	WC1-358-1603	W01-358-5702	17
9754	NBD-11689	1T14C7	Aluminum	WC1-358-1603	W01-358-8977	16
9754	NBD-11689	1T14C7	Aluminum	WC1-358-1603	W01-358-8979	17

PRIMARY TRUCK & TRAILER

**INDEX BY PISTON COMPONENT NUMBER**

PISTON COMP NO.	PISTON DRAWING NO.	PISTON TYPE	PISTON MATERIALS	PISTON AON	FIRESTONE AON	PAGE NO.
9757	NBD-9242	(replaced by 9567)				
9760	NAD-11668	(replaced by 9482)				
9766	NAD-28978	1T19G5	Aluminum	WC1-358-0631	W01-358-5530	90
9766	NAD-28978	1T19G5	Aluminum	WC1-358-0631	W01-358-8092	89
9766	NAD-28978	1T19G5	Aluminum	WC1-358-0631	W01-358-8500	80
9766	NAD-28978	1T19G5	Aluminum	WC1-358-0631	W01-358-8760	80
9766	NAD-28978	1T19G5	Aluminum	WC1-358-0631	W01-358-9200	80
9766	NAD-28978	1T19G5	Aluminum	WC1-358-0631	W01-358-9206	81
9766	NAD-28978	1T19G5	Aluminum	WC1-358-0631	W01-358-9215	81
9766	NAD-28978	1T19G5	Aluminum	WC1-358-0631	W01-358-9218	81
9766	NAD-28978	1T19G5	Aluminum	WC1-358-0631	W01-358-9801	81
9766	NAD-28978	1T19G5	Aluminum	WC1-358-0631	W01-358-9811	84
9767	NAD-15321	(replaced by 9766)				
9778	NAD-18053	1T14F4	Aluminum	N/A	W01-358-5335	15
9778	NAD-18053	1T14F4	Aluminum	N/A	W01-358-5336	15
9778	NAD-18053	1T14F4	Aluminum	N/A	W01-358-5345	15
9778	NAD-18053	1T14F4	Aluminum	N/A	W01-358-5410	14
9778	NAD-18053	1T14F4	Aluminum	N/A	W01-358-5412	14
9778	NAD-18053	1T14F4	Aluminum	N/A	W01-358-5414	14
9778	NAD-18053	1T14F4	Aluminum	N/A	W01-358-5426	17
9786	NBD-8514	(replaced by 9691)				
9796	NAD-17742	(replaced by 9666)				
9802	NAD-27999	1T17B7	Aluminum	WC1-358-1611	W01-358-8710	79
9803	NAD-15324	1T15V11	Aluminum	WC1-358-0680	W01-358-9250	70
9804	NBD-9171	(replaced by 9528)				
9809	NBD-9611	1T15L6	Aluminum	N/A	W01-358-9966	50
9809	NDD-3581	1T15L6	Aluminum	N/A	W01-358-9966	50
9809	NBD-9611	(replaced by 9583)				
9889	NBD-9253	1T26D7	Aluminum	N/A	W01-358-9310	91
9889	NBD-9253	1T26D7	Aluminum	N/A	W01-358-9327	91
9951	NAD-17833	1T15M6	Aluminum	WC1-358-0697	W01-358-9210	47
9951	NAD-17833	1T15M6	Aluminum	WC1-358-0697	W01-358-9211	48

PRIMARY TRUCK & TRAILER  
**INDEX BY PISTON DRAWING NUMBER**

PISTON DRAWING NO.	PISTON COMP. NO.	PISTON TYPE	PISTON MATERIALS	PISTON AON	FIRESTONE AON	PAGE NO.
FIP-100742	9492	1T15T0	Composite	N/A	W01-358-5766	65
FIP-100742	9492	1T15T0	Composite	N/A	W01-358-5792	67
FIP-100742	9492	1T15T0	Composite	N/A	W01-358-9401	65
FIP-100742	9492	1T15T0	Composite	N/A	W01-358-9402	65
FIP-100742	9492	1T15T0	Composite	N/A	W01-358-9421	66
FIP-100743	9493	1T14C1	Composite	N/A	W01-358-5298	18
FIP-100743	9493	1T14C1	Composite	N/A	W01-358-5319	18
FIP-100743	9493	1T14C1	Composite	N/A	W01-358-5730	16
FIP-100743	9493	1T14C1	Composite	N/A	W01-358-9478	15
FIP-100744	9491	1T14C1	Composite	N/A	W01-358-2119	12
FIP-100744	9491	1T14C1	Composite	N/A	W01-358-2131	12
FIP-100744	9491	1T14C1	Composite	N/A	W01-358-5297	18
FIP-100744	9491	1T14C1	Composite	N/A	W01-358-5379	18
FIP-100744	9491	1T14C1	Composite	N/A	W01-358-8992	19
FIP-100744	9491	1T14C1	Composite	N/A	W01-358-8997	19
FIP-101012	9490	1T15M2	Composite	N/A	W01-358-8195	36
FIP-101012	9490	1T15M2	Composite	N/A	W01-358-9469	24
FIP-101115	9488	1T17C8	Composite	N/A	W01-358-8109	77
FIP-101136	9640	1T19ZK5.7	Aluminum	N/A	W01-358-8050	91
FIP-101211	9489	1T15	Composite	WC1-358-1660	W01-358-9807	39
FIP-101361	9489	1T15	Composite	WC1-358-1660	W01-358-9807	39
FIP-101468	9484	1T15M6	Composite	WC1-358-1674	W01-358-9978	44
FIP-101526	4008	1T15MR	Composite	N/A	W01-358-1190	73
FIP-101526	4008	1T15MR	Composite	N/A	W01-358-1191	73
FIP-101526	4008	1T15MR	Composite	N/A	W01-358-1192	73
FIP-101526	4008	1T15MR	Composite	N/A	W01-358-8829	72
FIP-101526	4008	1T15MR	Composite	N/A	W01-358-9648	73
FIP-101526	4008	1T15MR	Composite	N/A	W01-M58-8463	72
FIP-101526	4008	1T15MR	Composite	N/A	W01-M58-8468	73
FIP-101543	9583	1T15L-6	Composite	N/A	W01-358-8720	75
FIP-101543	9583	1T15L-6	Composite	N/A	W01-358-9223	48
FIP-101543	9585	1T15L-6	Composite	N/A	W01-358-9749	25
FIP-101678	9461	1T66	Steel	N/A	W01-358-8984	92
FIP-101705	9485	1T15MR8	Composite	N/A	W01-358-9865	71
FIP-101705	9485	1T15MR8	Composite	N/A	W01-358-9866	71
FIP-101776	9462	1T15V7	Composite	N/A	W01-358-9274	68
FIP-101776	9462	1T15V7	Composite	N/A	W01-358-9275	69
FIP-101776	9462	1T15V7	Composite	N/A	W01-358-9467	43

PRIMARY TRUCK & TRAILER  
**INDEX BY PISTON DRAWING NUMBER**

PISTON DRAWING NO.	PISTON COMP. NO.	PISTON TYPE	PISTON MATERIALS	PISTON AON	FIRESTONE AON	PAGE NO.
FIP-101791	9587	1T19ZK5.7	Aluminum	N/A	W01-358-8050	91
FIP-101791	9587	1T19ZK5.7	Aluminum	N/A	W01-358-8050	91
FIP-103583	9618	1T15MM9	Aluminum	WC1-358-1694	W01-358-8944	61
FIP-103583	9618	1T15MM9	Aluminum	WC1-358-1694	W01-358-9265	61
FIP-103583	9618	1T15MM9	Aluminum	WC1-358-1694	W01-358-9299	64
FIP-103584	9622	1T15M2	Aluminum	WC1-358-1608	W01-358-9640	63
FIP-103585	9616	1T15V5	Aluminum	WC1-358-1635	W01-358-8723	74
FIP-103585	9616	1T15V5	Aluminum	WC1-358-1635	W01-358-8735	79
FIP-103585	9616	1T15V5	Aluminum	WC1-358-1635	W01-358-8782	75
FIP-103585	9616	1T15V5	Aluminum	WC1-358-1635	W01-358-8828	62
FIP-103587	9620	1T14F4	Aluminum	N/A	W01-358-5335	15
FIP-103587	9620	1T14F4	Aluminum	N/A	W01-358-5336	15
FIP-103587	9620	1T14F4	Aluminum	N/A	W01-358-5345	15
FIP-103587	9620	1T14F4	Aluminum	N/A	W01-358-5410	14
FIP-103587	9620	1T14F4	Aluminum	N/A	W01-358-5412	14
FIP-103587	9620	1T14F4	Aluminum	N/A	W01-358-5414	14
FIP-103587	9620	1T14F4	Aluminum	N/A	W01-358-5426	17
FIP-103588	9621	1T15M4	Aluminum	WC1-358-0651	W01-358-8805	40
FIP-103588	9621	1T15M4	Aluminum	WC1-358-0651	W01-358-9010	41
FIP-103588	9621	1T15M4	Aluminum	WC1-358-0651	W01-358-9056	42
FIP-103588	9621	1T15M4	Aluminum	WC1-358-0651	W01-358-9059	42
FIP-103588	9621	1T15M4	Aluminum	WC1-358-0651	W01-358-9071	42
FIP-103588	9621	1T15M4	Aluminum	WC1-358-0651	W01-358-9474	50
FIP-103588	9621	1T15M4	Aluminum	WC1-358-0651	W01-358-9491	70
FIP-103588	9621	1T15M4	Aluminum	WC1-358-0651	W01-358-9507	44
FIP-103589	9617	1T14C3	Aluminum	WC1-358-9095	W01-358-5343	13
FIP-103589	9617	1T14C3	Aluminum	WC1-358-9095	W01-358-5354	16
FIP-103589	9617	1T14C3	Aluminum	WC1-358-9095	W01-358-5423	14
FIP-103589	9617	1T14C3	Aluminum	WC1-358-9095	W01-358-8868	16
FIP-103594	9478	1T15M6	Aluminum	WC1-358-1610	W01-358-8755	75
FIP-103894	6853	1T14C1	Aluminum	WC1-358-0600	W01-358-5310	12
FIP-103894	6853	1T14C1	Aluminum	WC1-358-0600	W01-358-5311	12
FIP-103894	6853	1T14C1	Aluminum	WC1-358-0600	W01-358-5323	13
FIP-103894	6853	1T14C1	Aluminum	WC1-358-0600	W01-358-5405	13
FIP-103894	6853	1T14C1	Aluminum	WC1-358-0600	W01-358-5406	13
FIP-103894	6853	1T14C1	Aluminum	WC1-358-0600	W01-358-5408	13
FIP-103894	6853	1T14C1	Aluminum	WC1-358-0600	W01-358-5422	14
FIP-103894	6853	1T14C1	Aluminum	WC1-358-0600	W01-358-5434	15

PRIMARY TRUCK & TRAILER  
**INDEX BY PISTON DRAWING NUMBER**

PISTON DRAWING NO.	PISTON COMP. NO.	PISTON TYPE	PISTON MATERIALS	PISTON AON	FIRESTONE AON	PAGE NO.
FIP-103894	6853	1T14C1	Aluminum	WC1-358-0600	W01-358-5712	17
FIP-103896	6851	1T15M0	Aluminum	WC1-358-0663	W01-358-9031	34
FIP-103896	6851	1T15M0	Aluminum	WC1-358-0663	W01-358-9036	34
FIP-103896	6851	1T15M0	Aluminum	WC1-358-0663	W01-358-9308	34
FIP-103896	6851	1T15M0	Aluminum	WC1-358-0663	W01-358-9334	35
FIP-103896	6851	1T15M0	Aluminum	WC1-358-0663	W01-358-9650	65
FIP-103897	6850	1T15M2	Aluminum	N/A	W01-358-9391	24
FIP-103897	6851	1T15M3	Aluminum	N/A	W01-358-9391	24
FIP-103898	6849	1T15M6	Aluminum	N/A	W01-358-9971	52
FIP-103898	6849	1T15M6	Aluminum	N/A	W01-358-9974	53
FIP-103899	6848	1T19G5	Aluminum	WC1-358-0631	W01-358-5530	90
FIP-103899	6848	1T19G5	Aluminum	WC1-358-0631	W01-358-8500	80
FIP-103899	6848	1T19G5	Aluminum	WC1-358-0631	W01-358-8760	80
FIP-103899	6848	1T19G5	Aluminum	WC1-358-0631	W01-358-9200	80
FIP-103899	6848	1T19G5	Aluminum	WC1-358-0631	W01-358-9206	81
FIP-103899	6848	1T19G5	Aluminum	WC1-358-0631	W01-358-9215	81
FIP-103899	6848	1T19G5	Aluminum	WC1-358-0631	W01-358-9218	81
FIP-103899	6848	1T19G5	Aluminum	WC1-358-0631	W01-358-9801	81
FIP-103899	6848	1T19G5	Aluminum	WC1-358-0631	W01-358-9811	84
FIP-103899	6848	1T19G5	Aluminum	WC1-358-0631	W01-358-9200	80
FIP-103901	6846	1T19G9	Aluminum	N/A	W01-358-8793	90
FIP-103901	6846	1T19G9	Aluminum	N/A	W01-358-9825	90
FIP-103902	6845	1T17B7	Aluminum	WC1-358-1611	W01-358-8710	79
FIP-103972	6836	1T15M4	Composite	WC1-358-0666	W01-358-9069	42
NAD-15324	9803	1T15V11	Aluminum	WC1-358-0680	W01-358-9250	70
NAD-16485	9753	1T19E2	Aluminum	N/A	W01-M58-6339	86
NAD-17160	3808	1T19E1	Aluminum	N/A	W01-M58-8775	88
NAD-17833	9951	1T15M6	Aluminum	WC1-358-0697	W01-358-9210	47
NAD-17833	9951	1T15M6	Aluminum	WC1-358-0697	W01-358-9211	48
NAD-18053	9778	1T14F4	Aluminum	N/A	W01-358-5335	15
NAD-18053	9778	1T14F4	Aluminum	N/A	W01-358-5336	15
NAD-18053	9778	1T14F4	Aluminum	N/A	W01-358-5345	15
NAD-18053	9778	1T14F4	Aluminum	N/A	W01-358-5410	14
NAD-18053	9778	1T14F4	Aluminum	N/A	W01-358-5412	14
NAD-18053	9778	1T14F4	Aluminum	N/A	W01-358-5414	14
NAD-18053	9778	1T14F4	Aluminum	N/A	W01-358-5426	17
NAD-18101	9657	1T19E1	Aluminum	WC1-358-9450	W01-358-8778	81
NAD-18101	9657	1T19E1	Aluminum	WC1-358-9450	W01-358-8780	84

PRIMARY TRUCK & TRAILER  
**INDEX BY PISTON DRAWING NUMBER**

PISTON DRAWING NO.	PISTON COMP. NO.	PISTON TYPE	PISTON MATERIALS	PISTON AON	FIRESTONE AON	PAGE NO.
NAD-18101	9657	1T19E1	Aluminum	WC1-358-9450	W01-358-9121	82
NAD-18101	9657	1T19E1	Aluminum	WC1-358-9450	W01-358-9134	84
NAD-18101	9657	1T19E1	Aluminum	WC1-358-9450	W01-358-9138	85
NAD-18101	9657	1T19E1	Aluminum	WC1-358-9450	W01-358-9141	82
NAD-18101	9657	1T19E1	Aluminum	WC1-358-9450	W01-358-9144	82
NAD-18101	9657	1T19E1	Aluminum	WC1-358-9450	W01-358-9148	83
NAD-18101	9657	1T19E1	Aluminum	WC1-358-9450	W01-358-9149	83
NAD-18101	9657	1T19E1	Aluminum	WC1-358-9450	W01-358-9177	83
NAD-18101	9657	1T19E1	Aluminum	WC1-358-9450	W01-358-9221	83
NAD-18101	9657	1T19E1	Aluminum	WC1-358-9450	W01-358-9804	86
NAD-18102	9658	1T19E2	Aluminum	N/A	W01-358-8792	85
NAD-18130	9571	1T15KW1.5	Composite	WC1-358-0646	W01-358-8897	20
NAD-18130	9571	1T15KW1.5	Composite	WC1-358-0646	W01-358-8964	33
NAD-18130	9571	1T15KW1.5	Composite	WC1-358-0646	W01-358-9376	20
NAD-18130	9571	1T15KW1.5	Composite	WC1-358-0646	W01-358-9422	19
NAD-18130	9571	1T15KW1	Composite	WC1-358-0646	W01-358-9551	22
NAD-18130	9571	1T15KW1.5	Composite	WC1-358-0646	W01-358-9616	20
NAD-18130	9571	1T15KW1.5	Composite	WC1-358-0646	W01-358-9651	65
NAD-18161	9572	1T15KW1.5	Composite	N/A	W01-358-8961	33
NAD-18161	9572	1T15KW1.5	Composite	N/A	W01-358-9562	22
NAD-18161	9572	1T15KW1.5	Composite	N/A	W01-358-9750	31
NAD-18162	9570	1T15KW1.5	Composite	N/A	W01-358-8970	35
NAD-18162	9570	1T15KW1.5	Composite	N/A	W01-358-9306	35
NAD-18162	9570	1T15KW1.5	Composite	N/A	W01-358-9584	20
NAD-18162	9573	1T15KW1.5	Composite	WC1-358-1634	W01-358-8197	36
NAD-18162	9573	1T15KW1.5	Composite	WC1-358-1634	W01-358-8204	36
NAD-18162	9573	1T15KW1.5	Composite	WC1-358-1634	W01-358-8816	41
NAD-18162	9573	1T15KW1.5	Composite	WC1-358-1634	W01-358-8817	41
NAD-18162	9573	1T15KW1.5	Composite	WC1-358-1634	W01-358-8938	37
NAD-18162	9573	1T15KW1	Composite	WC1-358-1634	W01-358-8938	37
NAD-18162	9573	1T15KW1.5	Composite	WC1-358-1634	W01-358-8971	33
NAD-18162	9573	1T15KW1.5	Composite	WC1-358-1634	W01-358-9294	32
NAD-18162	9573	1T15KW1.5	Composite	WC1-358-1634	W01-358-9307	35
NAD-18162	9573	1T15KW1.5	Composite	WC1-358-1634	W01-358-9335	43
NAD-18162	9573	1T15KW1	Composite	WC1-358-1634	W01-358-9339	39
NAD-18162	9573	1T15KW1.5	Composite	WC1-358-1634	W01-358-9387	21
NAD-18162	9573	1T15KW1.5	Composite	WC1-358-1634	W01-M58-9851	60
NAD-19631	9666	1T19G9	Aluminum	N/A	W01-358-8793	90

PRIMARY TRUCK & TRAILER

**INDEX BY PISTON DRAWING NUMBER**

PISTON DRAWING NO.	PISTON COMP. NO.	PISTON TYPE	PISTON MATERIALS	PISTON AON	FIRESTONE AON	PAGE NO.
NAD-19631	9666	1T19G9	Aluminum	N/A	W01-358-9825	90
NAD-25396	9694	1T15MM9	Aluminum	WC1-358-1694	W01-358-8944	61
NAD-25396	9694	1T15MM9	Aluminum	WC1-358-1694	W01-358-9265	61
NAD-25396	9694	1T15MM9	Aluminum	WC1-358-1694	W01-358-9299	64
NAD-26291	9669	1T19F12	Aluminum	WC1-358-1602	W01-358-5505	87
NAD-26291	9669	1T19F12	Aluminum	WC1-358-1602	W01-358-5508	87
NAD-26291	9669	1T19F12	Aluminum	WC1-358-1602	W01-358-9264	88
NAD-26291	9669	1T19F12	Aluminum	WC1-358-1602	W01-358-9891	87
NAD-26291	9669	1T19F12	Aluminum	WC1-358-1602	W01-358-9896	88
NAD-26291	9669	1T19F12	Aluminum	WC1-358-1602	W01-358-9915	88
NAD-26291	9669	1T19F12	Aluminum	WC1-358-1602	W01-358-9928	88
NAD-26906	9525	1T17B6	Composite	WC1-358-1609	W01-358-8709	78
NAD-27265	9527	1T15ZR6	Composite	WC1-358-1627	W01-358-9780	72
NAD-27357	9702	1T15M2	Aluminum	WC1-358-1608	W01-358-9640	63
NAD-27740	9538	1T15M6	Composite	WC1-358-1628	W01-358-8591	45
NAD-27740	9538	1T15M6	Composite	WC1-358-1628	W01-358-9297	53
NAD-27740	9538	1T15M6	Composite	WC1-358-1628	W01-358-9373	53
NAD-27740	9538	1T15M6	Composite	WC1-358-1628	W01-358-9375	54
NAD-27740	9538	1T15M6	Composite	WC1-358-1628	W01-358-9641	54
NAD-27740	9538	1T15M6	Composite	WC1-358-1628	W01-358-9643	64
NAD-27740	9538	1T15M6	Composite	WC1-358-1628	W01-358-9643	64
NAD-27740	9538	1T15M6	Composite	WC1-358-1628	W01-358-9647	54
NAD-27740	9538	1T15M6	Composite	WC1-358-1628	W01-M58-9372	55
NAD-27740	9538	1T15M6	Composite	WC1-358-1628	W01-M58-9656	55
NAD-27740	9538	1T15M6	Composite	WC1-358-1628/ WC1-358-3715	W01-358-9654	54
NAD-27740	9538	1T15M6	Composite	WC1-358-1628/ WC1-358-3715	W01-358-9663	55
NAD-27754	9569	1T15KW0	Composite	WC1-358-1629	W01-358-9541	26
NAD-27754	9569	1T15KW0	Composite	WC1-358-1629	W01-358-9547	25
NAD-27754	9569	1T15KW0	Composite	WC1-358-1629	W01-358-9554	28
NAD-27754	9569	1T15KW0	Composite	WC1-358-1629	W01-358-9617	25
NAD-27754	9569	1T15KW0	Composite	WC1-358-1629	W01-358-9618	26
NAD-27754	9569	1T15KW0	Composite	WC1-358-1629	W01-358-9622	26
NAD-27754	9569	1T15KW0	Composite	WC1-358-1629	W01-358-9625	26
NAD-27754	9569	1T15KW0	Composite	WC1-358-1629	W01-358-9675	26
NAD-27809	9530	1T15M6	Composite	WC1-358-9452	W01-358-0783	55
NAD-27809	9530	1T15M6	Composite	WC1-358-9452	W01-358-8824	45
NAD-27809	9530	1T15M6	Composite	WC1-358-9452	W01-358-8825	45

PRIMARY TRUCK & TRAILER

**INDEX BY PISTON DRAWING NUMBER**

PISTON DRAWING NO.	PISTON COMP. NO.	PISTON TYPE	PISTON MATERIALS	PISTON AON	FIRESTONE AON	PAGE NO.
NAD-27809	9530	1T15M6	Composite	WC1-358-9452	W01-358-8855	56
NAD-27809	9530	1T15M6	Composite	WC1-358-9452	W01-358-8861	56
NAD-27809	9530	1T15M6	Composite	WC1-358-9452	W01-358-8888	50
NAD-27809	9530	1T15M6	Composite	WC1-358-9452	W01-358-8924	45
NAD-27809	9530	1T15M6	Composite	WC1-358-9452	W01-358-8932	37
NAD-27809	9530	1T15M6	Composite	WC1-358-9452	W01-358-9082	46
NAD-27809	9530	1T15M6	Composite	WC1-358-9452	W01-358-9083	46
NAD-27809	9530	1T15M6	Composite	WC1-358-9452	W01-358-9092	46
NAD-27809	9530	1T15M6	Composite	WC1-358-9452	W01-358-9096	47
NAD-27809	9530	1T15M6	Composite	WC1-358-9452	W01-358-9192	57
NAD-27809	9530	1T15M6	Composite	WC1-358-9452	W01-358-9193	47
NAD-27809	9530	1T15M6	Composite	WC1-358-9452	W01-358-9203	57
NAD-27809	9530	1T15M6	Composite	WC1-358-9452	W01-358-9227	48
NAD-27809	9530	1T15M6	Composite	WC1-358-9452	W01-358-9245	58
NAD-27809	9530	1T15M6	Composite	WC1-358-9452	W01-358-9342	50
NAD-27809	9530	1T15M6	Composite	WC1-358-9452	W01-358-9502	70
NAD-27809	9530	1T15M6	Composite	WC1-358-9452	W01-358-9560	25
NAD-27909	9580	1T19F11	Composite	WC1-358-0528	W01-358-5503	86
NAD-27909	9580	1T19F11	Composite	WC1-358-0528	W01-358-5511	87
NAD-27909	9580	1T19F11	Composite	WC1-358-0528	W01-358-5514	87
NAD-27909	9580	1T19F11	Composite	WC1-358-0528	W01-358-8781	84
NAD-27909	9580	1T19F11	Composite	WC1-358-0528	W01-358-8796	85
NAD-27909	9580	1T19F11	Composite	WC1-358-0528	W01-358-9122	85
NAD-27909	9580	1T19F11	Composite	WC1-358-0528	W01-358-9156	85
NAD-27909	9580	1T19F11	Composite	WC1-358-0528	W01-358-9158	86
NAD-27999	9802	1T17B7	Aluminum	WC1-358-1611	W01-358-8710	79
NAD-28002	9734	1T15M6	Aluminum	WC1-358-1610	W01-358-8755	75
NAD-28198	3850	1T15MP6	Composite	N/A	W01-M58-7074	62
NAD-28198	3850	1T15MP6	Composite	N/A	W01-M58-8608	80
NAD-28351	9602	1T15V5	Aluminum	WC1-358-1613	W01-358-8637	77
NAD-28351	9602	1T15V5	Aluminum	WC1-358-1613	W01-358-8740	74
NAD-28351	9602	1T15V5	Aluminum	WC1-358-1613	W01-358-8752	74
NAD-28351	9602	1T15V5	Aluminum	WC1-358-1613	W01-358-8753	74
NAD-28351	9602	1T15V5	Aluminum	WC1-358-1613	W01-358-9270	71
NAD-28384	9594	1T19LC5	Composite	WC1-358-1614	W01-358-8091	89
NAD-28384	9594	1T19LC5	Composite	WC1-358-1614	W01-358-8093	89
NAD-28384	9594	1T19LC5	Composite	WC1-358-1614	W01-358-8539	80
NAD-28384	9594	1T19LC5	Composite	WC1-358-1614	W01-358-8774	90



PRIMARY TRUCK & TRAILER

**INDEX BY PISTON DRAWING NUMBER**

PISTON DRAWING NO.	PISTON COMP. NO.	PISTON TYPE	PISTON MATERIALS	PISTON AON	FIRESTONE AON	PAGE NO.
NAD-28978	9766	1T19G5	Aluminum	WC1-358-0631	W01-358-5530	90
NAD-28978	9766	1T19G5	Aluminum	WC1-358-0631	W01-358-8092	89
NAD-28978	9766	1T19G5	Aluminum	WC1-358-0631	W01-358-8500	80
NAD-28978	9766	1T19G5	Aluminum	WC1-358-0631	W01-358-8760	80
NAD-28978	9766	1T19G5	Aluminum	WC1-358-0631	W01-358-9200	80
NAD-28978	9766	1T19G5	Aluminum	WC1-358-0631	W01-358-9206	81
NAD-28978	9766	1T19G5	Aluminum	WC1-358-0631	W01-358-9215	81
NAD-28978	9766	1T19G5	Aluminum	WC1-358-0631	W01-358-9218	81
NAD-28978	9766	1T19G5	Aluminum	WC1-358-0631	W01-358-9801	81
NAD-28978	9766	1T19G5	Aluminum	WC1-358-0631	W01-358-9811	84
NAD-29454	9549	1T15M2	Composite	WC1-358-1616	W01-358-8203	36
NAD-29454	9549	1T15M2	Composite	WC1-358-1616	W01-358-8492	29
NAD-29454	9549	1T15M2	Composite	WC1-358-1616	W01-358-8647	22
NAD-29454	9549	1T15M2	Composite	WC1-358-1616	W01-358-8802	40
NAD-29454	9549	1T15M2	Composite	WC1-358-1616	W01-358-8874	23
NAD-29454	9549	1T15M2	Composite	WC1-358-1616	W01-358-8901	20
NAD-29454	9549	1T15M2	Composite	WC1-358-1616	W01-358-8919	23
NAD-29454	9549	1T15M2	Composite	WC1-358-1616	W01-358-8949	32
NAD-29454	9549	1T15M2	Composite	WC1-358-1616	W01-358-8959	28
NAD-29454	9549	1T15M2	Composite	WC1-358-1616	W01-358-9336	43
NAD-29454	9549	1T15M2	Composite	WC1-358-1616	W01-358-9366	39
NAD-29454	9549	1T15M2	Composite	WC1-358-1616	W01-358-9482	43
NAD-29454	9549	1T15M2	Composite	WC1-358-1616	W01-358-9585	44
NAD-29456	9550	1T15M2	Composite	WC1-358-1652	W01-358-8198	36
NAD-29456	9550	1T15M2	Composite	WC1-358-1652	W01-358-8466	63
NAD-29456	9550	1T15M2	Composite	WC1-358-1652	W01-358-8616	77
NAD-29456	9550	1T15M2	Composite	WC1-358-1652	W01-358-8878	37
NAD-29456	9550	1T15M2	Composite	WC1-358-1652	W01-358-9105	38
NAD-29456	9550	1T15M2	Composite	WC1-358-1652	W01-358-9303	38
NAD-29456	9550	1T15M2	Composite	WC1-358-1652	W01-358-9634	63
NAD-29467	9553	1T15M9	Composite	WC1-358-9453	W01-358-9093	47
NAD-29467	9553	1T15M9	Composite	WC1-358-9453	W01-358-9101	57
NAD-29467	9553	1T15M9	Composite	WC1-358-9453	W01-358-9130	57
NAD-29467	9553	1T15M9	Composite	WC1-358-9453	W01-358-9238	58
NAD-29467	9553	1T15M9	Composite	WC1-358-9453	W01-358-9240	58
NAD-29467	9553	1T15M9	Composite	WC1-358-9453	W01-358-9241	58
NAD-29467	9553	1T15M9	Composite	WC1-358-9453	W01-358-9320	59
NAD-29467	9553	1T15M9	Composite	WC1-358-9453	W01-358-9348	59

PRIMARY TRUCK & TRAILER

**INDEX BY PISTON DRAWING NUMBER**

PISTON DRAWING NO.	PISTON COMP. NO.	PISTON TYPE	PISTON MATERIALS	PISTON AON	FIRESTONE AON	PAGE NO.
NAD-29467	9553	1T15M9	Composite	WC1-358-9453	W01-358-9350	59
NAD-29467	9553	1T15M9	Composite	WC1-358-9453	W01-358-9368	60
NAD-29467	9553	1T15M9	Composite	WC1-358-9453	W01-358-9392	49
NAD-29467	9553	1T15M9	Composite	WC1-358-9453	W01-358-9394	59
NAD-29467	9553	1T15M9	Composite	WC1-358-9453	W01-358-9501	70
NAD-29467	9553	1T15M9	Composite	WC1-358-9453	W01-358-9504	70
NAD-29551	9528	1T15V1	Composite	WC1-358-0667	W01-358-8737	77
NAD-29592	9535	1T15S6	Composite	N/A	W01-358-9260	64
NAD-29592	9535	1T15S6	Composite	N/A	W01-358-9278	64
NAD-29630	9603	1T15V5	Aluminum	WC1-358-1635	W01-358-8723	74
NAD-29630	9603	1T15V5	Aluminum	WC1-358-1635	W01-358-8735	79
NAD-29630	9603	1T15V5	Aluminum	WC1-358-1635	W01-358-8782	75
NAD-29630	9603	1T15V5	Aluminum	WC1-358-1635	W01-358-8828	62
NAD-29798	9537	1T17B7	Composite	WC1-358-1637	W01-358-8708	78
NAD-29798	9537	1T17B7	Composite	WC1-358-1637	W01-358-8713	78
NAD-29826	9544	1T15M4	Composite	WC1-358-0666	W01-358-8813	41
NAD-29826	9544	1T15M4	Composite	WC1-358-0666	W01-358-8927	46
NAD-29826	9544	1T15M4	Composite	WC1-358-0666	W01-358-9069	42
NAD-29826	9544	1T15M4	Composite	WC1-358-0666	W01-358-9293	32
NAD-29826	9544	1T15M4	Composite	WC1-358-0666	W01-358-9365	39
NAD-29826	9544	1T15M4	Composite	WC1-358-0666	W01-358-9472	69
NAD-29826	9544	1T15M4	Composite	WC1-358-0666	W01-358-9484	43
NAD-29826	9544	1T15M4	Composite	WC1-358-0666	W01-358-9902	51
NAD-29826	9544	1T15M4	Composite	WC1-358-0666	W01-358-9921	51
NAD-29826	9544	1T15M4	Composite	WC1-358-0666	W01-358-9936	52
NAD-29826	9544	1T15M4	Composite	WC1-358-0666	W01-358-9947	52
NAD-29827	9531	1T15MP6	Composite	N/A	W01-358-8864	56
NAD-29827	9532	1T15M6	Composite	WC1-358-1619	W01-358-8494	62
NAD-29827	9532	1T15M6	Composite	WC1-358-1619	W01-358-8746	75
NAD-29827	9532	1T15M6	Composite	WC1-358-1619	W01-358-8748	76
NAD-29827	9532	1T15M6	Composite	WC1-358-1619	W01-358-8803	40
NAD-29827	9532	1T15M6	Composite	WC1-358-1619	W01-358-8842	55
NAD-29827	9532	1T15M6	Composite	WC1-358-1619	W01-358-8852	56
NAD-29827	9532	1T15M6	Composite	WC1-358-1619	W01-358-8856	56
NAD-29827	9532	1T15M6	Composite	WC1-358-1619	W01-358-8903	63
NAD-29827	9532	1T15M6	Composite	WC1-358-1619	W01-358-9026	46
NAD-29827	9532	1T15M6	Composite	WC1-358-1619	W01-358-9194	47
NAD-29827	9532	1T15M6	Composite	WC1-358-1619	W01-358-9243	58

PRIMARY TRUCK & TRAILER  
**INDEX BY PISTON DRAWING NUMBER**

PISTON DRAWING NO.	PISTON COMP. NO.	PISTON TYPE	PISTON MATERIALS	PISTON AON	FIRESTONE AON	PAGE NO.
NAD-29827	9532	1T15M6	Composite	WC1-358-1619	W01-358-9295	33
NAD-29827	9532	1T15M6	Composite	WC1-358-1619	W01-358-9325	39
NAD-29827	9532	1T15M6	Composite	WC1-358-1619	W01-358-9362	49
NAD-29827	9532	1T15M6	Composite	WC1-358-1619	W01-358-9470	69
NAD-29827	9532	1T15M6	Composite	WC1-358-1619	W01-358-9496	50
NAD-29827	9532	1T15M6	Composite	WC1-358-1619	W01-358-9621	27
NAD-29827	9532	1T15M6	Composite	WC1-358-1619	W01-358-9626	25
NAD-29827	9532	1T15M6	Composite	WC1-358-1619	W01-358-9644	61
NAD-29827	9532	1T15M6	Composite	WC1-358-1619	W01-358-9646	61
NAD-29827	9532	1T15M6	Composite	WC1-358-1619	W01-358-9697	44
NAD-29827	9532	1T15M6	Composite	WC1-358-1619	W01-358-9923	51
NAD-29827	9532	1T15M6	Composite	WC1-358-1619	W01-358-9935	51
NAD-29827	9532	1T15M6	Composite	WC1-358-1619	W01-358-9942	52
NAD-29828	9540	1T15M9	Composite	WC1-358-0664	W01-358-8744	75
NAD-29828	9540	1T15M9	Composite	WC1-358-0664	W01-358-8749	76
NAD-29828	9540	1T15M9	Composite	WC1-358-0664	W01-358-9291	32
NAD-29828	9540	1T15M9	Composite	WC1-358-0664	W01-358-9304	49
NAD-29828	9540	1T15M9	Composite	WC1-358-0664	W01-358-9346	59
NAD-29828	9540	1T15M9	Composite	WC1-358-0664	W01-358-9370	60
NAD-29828	9540	1T15M9	Composite	WC1-358-0664	W01-358-9471	69
NAD-29828	9540	1T15M9	Composite	WC1-358-0664	W01-358-9473	69
NAD-29828	9540	1T15M9	Composite	WC1-358-0664	W01-358-9619	28
NAD-29828	9540	1T15M9	Composite	WC1-358-0664	W01-358-9645	61
NAD-29828	9540	1T15M9	Composite	WC1-358-0664	W01-358-9922	51
NAD-29828	9540	1T15M9	Composite	WC1-358-0664	W01-358-9943	52
NAD-30174	9604	1T15ZR6	Aluminum	WC1-358-1624	W01-358-9781	72
NAD-30515	9533	1T17BB2	Composite	N/A	W01-358-8617	79
NAD-30515	9533	1T17BB2	Composite	N/A	W01-358-8729	76
NAD-31181	9557	1T15MP6	Composite	N/A	W01-358-6258	71
NAD-31181	9557	1T15MP6	Composite	N/A	W01-358-6262	62
NAD-31215	9646	1T17B17	Steel	N/A	W01-358-8724	76
NAD-31288	9648	1T17B4	Steel	WC1-358-1649	W01-358-8614	78
NAD-31288	9648	1T17B4	Steel	WC1-358-1649	W01-358-8631	74
NAD-31288	9648	1T17B4	Steel	WC1-358-1649	W01-358-8800	71
NAD-31612	9676	1T15ZR6	Steel	N/A	W01-358-9782	72
NAD-31622	9645	1T15CCR6	Steel	N/A	W01-358-8184	19
NAD-31763	9507	1T15MP6	Composite	N/A	W01-358-6231	62
NAD-31862	9644	1T19ZR6.2	Steel	WC1-358-9999	W01-358-5523	90

PRIMARY TRUCK & TRAILER  
**INDEX BY PISTON DRAWING NUMBER**

PISTON DRAWING NO.	PISTON COMP. NO.	PISTON TYPE	PISTON MATERIALS	PISTON AON	FIRESTONE AON	PAGE NO.
NAD-31862	9644	1T19ZR6.2	Steel	WC1-358-9999	W01-358-8052	91
NAD-31862	9644	1T19ZR6.2	Steel	WC1-358-9999	W01-358-8053	91
NAD-32767	9561	1T15M6	Composite	WC1-358-1606	W01-358-8831	64
NAD-32767	9561	1T15M6	Composite	WC1-358-1606	W01-358-9287	53
NAD-32767	9561	1T15M6	Composite	WC1-358-1606	W01-358-9466	49
NAD-32767	9561	1T15M6	Composite	WC1-358-1606	W01-358-9649	54
NAD-32768	9560	1T15M6	Composite	WC1-358-1620	W01-358-9213	48
NAD-32768	9560	1T15M6	Composite	WC1-358-1620	W01-358-9219	48
NAD-32768	9560	1T15M6	Composite	WC1-358-1620	W01-358-9296	49
NAD-32768	9560	1T15M6	Composite	WC1-358-1620	W01-358-9371	53
NAD-33165	9699	1T17BM6	Aluminum	N/A	W01-358-8673	76
NAD-33610	9562	1T19L9	Composite	N/A	W01-358-8980	82
NAD-33610	9562	1T19L9	Composite	N/A	W01-358-9280	83
NAD-33610	9562	1T19L9	Composite	N/A	W01-358-9985	86
NAD-34318	3894	1T19G5	Aluminum	N/A	W01-M58-8798	89
NAD-34837	3881	1T15MP6	Composite	N/A	W01-M58-7074	62
NAD-34837	3881	1T15MP6	Composite	N/A	W01-M58-8608	80
NAD-35451	9565	1T15	Composite	N/A	W01-358-9049	29
NAD-35451	9565	1T15 7	Composite	N/A	W01-358-9285	30
NAD-35451	9565	1T15	Composite	N/A	W01-358-9652	31
NAD-35451	9566	1T15	Composite	N/A	W01-358-9017	29
NAD-35451	9566	1T15	Composite	N/A	W01-358-9073	29
NAD-35451	9566	1T15	Composite	N/A	W01-358-9290	30
NAD-35451	9566	1T15	Composite	N/A	W01-358-9539	30
NAD-35451	9566	1T15	Composite	N/A	W01-358-9592	30
NAD-35451	9566	1T15	Composite	N/A	W01-358-9595	31
NAD-35451	9567	1T15	Aluminum	N/A	W01-358-8478	29
NAD-35451	9567	1T15	Aluminum	N/A	W01-358-9587	30
NAD-35451	9567	1T15	Aluminum	N/A	W01-358-9597	31
NAD-35451	9567	1T15	Aluminum	N/A	W01-358-9599	31
NAD-35451	9567	1T15	Aluminum	N/A	W01-358-9953	32
NAD-35550	9606	1T15M2	Aluminum	N/A	W01-358-1096	45
NAD-35550	9606	1T15M2	Aluminum	N/A	W01-358-8806	40
NAD-35550	9606	1T15M2	Aluminum	N/A	W01-358-8810	41
NAD-35550	9606	1T15M2	Aluminum	N/A	W01-358-9053	38
NAD-35550	9606	1T15M2	Aluminum	N/A	W01-358-9070	42
NAD-35550	9606	1T15M2	Aluminum	N/A	W01-358-9118	38
NAD-35550	9606	1T15M2	Aluminum	N/A	W01-358-9439	24

PRIMARY TRUCK & TRAILER  
**INDEX BY PISTON DRAWING NUMBER**

PISTON DRAWING NO.	PISTON COMP. NO.	PISTON TYPE	PISTON MATERIALS	PISTON AON	FIRESTONE AON	PAGE NO.
NAD-35550	9606	1T15M2	Aluminum	N/A	W01-358-9441	24
NAD-35550	9606	1T15M2	Aluminum	N/A	W01-358-9797	44
NAD-35550	9606	1T15M2	Composite	WC1-358-1652	W01-358-9105	38
NAD-35550	9656	1T15M2	Aluminum	N/A	W01-358-9118	38
NAD-35551	9607	1T19E1	Aluminum	WC1-358-9450	W01-358-8778	81
NAD-35551	9607	1T19E1	Aluminum	WC1-358-9450	W01-358-8779	84
NAD-35551	9607	1T19E1	Aluminum	WC1-358-9450	W01-358-8780	84
NAD-35551	9607	1T19E1	Aluminum	WC1-358-9450	W01-358-9121	82
NAD-35551	9607	1T19E1	Aluminum	WC1-358-9450	W01-358-9134	84
NAD-35551	9607	1T19E1	Aluminum	WC1-358-9450	W01-358-9135	82
NAD-35551	9607	1T19E1	Aluminum	WC1-358-9450	W01-358-9138	85
NAD-35551	9607	1T19E1	Aluminum	WC1-358-9450	W01-358-9141	82
NAD-35551	9607	1T19E1	Aluminum	WC1-358-9450	W01-358-9144	82
NAD-35551	9607	1T19E1	Aluminum	WC1-358-9450	W01-358-9148	83
NAD-35551	9607	1T19E1	Aluminum	WC1-358-9450	W01-358-9149	83
NAD-35551	9607	1T19E1	Aluminum	WC1-358-9450	W01-358-9177	83
NAD-35551	9607	1T19E1	Aluminum	WC1-358-9450	W01-358-9221	83
NAD-35551	9607	1T19E1	Aluminum	WC1-358-9450	W01-358-9804	86
NAD-36702	9482	1T19E1	Aluminum	WC1-358-9450	W01-358-9135	82
NAD-37120	9639	1T15DR	Steel	N/A	W01-358-8525	19
NAD-37432	9586	1T15V5	Aluminum	WC1-358-1613	W01-358-8637	77
NAD-37432	9586	1T15V5	Aluminum	WC1-358-1613	W01-358-8740	74
NAD-37432	9586	1T15V5	Aluminum	WC1-358-1613	W01-358-8752	74
NAD-37432	9586	1T15V5	Aluminum	WC1-358-1613	W01-358-8753	74
NAD-37432	9586	1T15V5	Aluminum	WC1-358-1613	W01-358-9270	71
NAD-37989	3808	1T19E1	Aluminum	N/A	W01-M58-8775	88
NAD-37991	4034	1T19E2	Steel	N/A	W01-M58-6348	89
NAD-38033	9574	1T19E2	Aluminum	N/A	W01-M58-6339	86
NAD-38033	9574	1T19E2	Aluminum	N/A	W01-M58-6348	89
NAD-38338	9612	1T19E2	Aluminum	N/A	W01-358-8792	85
NAD-38338	9612	1T19F11	Composite	WC1-358-0528	W01-358-9122	85
NAD-38338	9612	1T19E2	Composite	WC1-358-0528	W01-358-9122	85
NAD-39259	9614	1T15ZR6	Aluminum	WC1-358-1624	W01-358-9781	72
NAD-39638	9477	1T15V11	Aluminum	WC1-358-1607	W01-358-9580	79
NAD-39638	9477	1T15V11	Aluminum	WC1-358-1607	W01-358-9581	79
NAD-39639	9476	1T15V11	Aluminum	N/A	W01-M58-8712	78
NAD-39687	4083	1T15V11	Aluminum	WC1-358-1607	W01-358-9580	79
NAD-39687	4083	1T15V11	Aluminum	WC1-358-1607	W01-358-9581	79

PRIMARY TRUCK & TRAILER  
**INDEX BY PISTON DRAWING NUMBER**

PISTON DRAWING NO.	PISTON COMP. NO.	PISTON TYPE	PISTON MATERIALS	PISTON AON	FIRESTONE AON	PAGE NO.
NAD-40125	6781	1T15MP6	Composite	N/A	W01-M58-7074	62
NAD-40125	6781	1T15M	Composite	N/A	W01-M58-7074	62
NAD-40208	3808	1T19E1	Aluminum	N/A	W01-M58-8775	88
NBD-8055	9742	1T15M2	Aluminum	N/A	W01-358-9078	38
NBD-8626	6853	1T14C1	Aluminum	WC1-358-0600	W01-358-5405	13
NBD-8626	6853	1T14C1	Aluminum	WC1-358-0600	W01-358-5408	13
NBD-8626	9708	1T14C1	Aluminum	WC1-358-0600	W01-358-5310	12
NBD-8626	9708	1T14C1	Aluminum	WC1-358-0600	W01-358-5311	12
NBD-8626	9708	1T14C1	Aluminum	WC1-358-0600	W01-358-5323	13
NBD-8626	9708	1T14C1	Aluminum	WC1-358-0600	W01-358-5405	13
NBD-8626	9708	1T14C1	Aluminum	WC1-358-0600	W01-358-5406	13
NBD-8626	9708	1T14C1	Aluminum	WC1-358-0600	W01-358-5408	13
NBD-8626	9708	1T14C1	Aluminum	WC1-358-0600	W01-358-5422	14
NBD-8626	9708	1T14C1	Aluminum	WC1-358-0600	W01-358-5434	15
NBD-8626	9708	1T14C1	Aluminum	WC1-358-0600	W01-358-5710	17
NBD-8626	9708	1T14C1	Aluminum	WC1-358-0600	W01-358-5712	17
NBD-8724	9727	1T15M4	Aluminum	WC1-358-0651	W01-358-8805	40
NBD-8724	9727	1T15M4	Aluminum	WC1-358-0651	W01-358-9010	41
NBD-8724	9727	1T15M4	Aluminum	WC1-358-0651	W01-358-9056	42
NBD-8724	9727	1T15M4	Aluminum	WC1-358-0651	W01-358-9059	42
NBD-8724	9727	1T15M4	Aluminum	WC1-358-0651	W01-358-9071	42
NBD-8724	9727	1T15M4	Aluminum	WC1-358-0651	W01-358-9474	50
NBD-8724	9727	1T15M4	Aluminum	WC1-358-0651	W01-358-9491	70
NBD-8724	9727	1T15M4	Aluminum	WC1-358-0651	W01-358-9507	44
NBD-9253	9889	1T26D7	Aluminum	N/A	W01-358-9310	91
NBD-9253	9889	1T26D7	Aluminum	N/A	W01-358-9327	91
NBD-9611	9809	1T15L6	Aluminum	N/A	W01-358-9966	50
NBD-10378	3822	1T15M2	Aluminum	N/A	W01-358-8931	37
NBD-10378	3822	1T15M2	Aluminum	N/A	W01-358-9391	24
NBD-10378	6850	1T15M2	Aluminum	N/A	W01-358-9391	24
NBD-10436	9652	1T15M6	Aluminum	N/A	W01-358-9971	52
NBD-10436	9652	1T15M6	Aluminum	N/A	W01-358-9974	53
NBD-10437	9653	1T15M9	Aluminum	WC1-358-0620	W01-358-9106	57
NBD-10437	9653	1T15M9	Aluminum	WC1-358-0620	W01-358-9321	60
NBD-10437	9653	1T15M9	Aluminum	WC1-358-0620	W01-358-9367	60
NBD-10438	9654	1T15M0	Aluminum	WC1-358-0663	W01-358-9031	34
NBD-10438	9654	1T15M0	Aluminum	WC1-358-0663	W01-358-9036	34
NBD-10438	9654	1T15M0	Aluminum	WC1-358-0663	W01-358-9308	34

PRIMARY TRUCK & TRAILER  
**INDEX BY PISTON DRAWING NUMBER**

PISTON DRAWING NO.	PISTON COMP. NO.	PISTON TYPE	PISTON MATERIALS	PISTON AON	FIRESTONE AON	PAGE NO.
NBD-10438	9654	1T15M0	Aluminum	WC1-358-0663	W01-358-9333	35
NBD-10438	9654	1T15M0	Aluminum	WC1-358-0663	W01-358-9334	35
NBD-10438	9654	1T15M0	Aluminum	WC1-358-0663	W01-358-9650	65
NBD-10439	9655	1T15M0	Aluminum	WC1-358-9454	W01-358-8963	33
NBD-10439	9655	1T15M0	Aluminum	WC1-358-9454	W01-358-9033	34
NBD-10439	9655	1T15M0	Aluminum	WC1-358-9454	W01-358-9039	34
NBD-10439	9655	1T15M0	Aluminum	WC1-358-9454	W01-358-9423	66
NBD-10440	9656	1T15M2	Aluminum	N/A	W01-358-1096	45
NBD-10440	9656	1T15M2	Aluminum	N/A	W01-358-8806	40
NBD-10440	9656	1T15M2	Aluminum	N/A	W01-358-8810	41
NBD-10440	9656	1T15M2	Aluminum	N/A	W01-358-9053	38
NBD-10440	9656	1T15M2	Aluminum	N/A	W01-358-9070	42
NBD-10440	9656	1T15M2	Aluminum	N/A	W01-358-9118	38
NBD-10440	9656	1T15M2	Aluminum	N/A	W01-358-9439	24
NBD-10440	9656	1T15M2	Aluminum	N/A	W01-358-9441	24
NBD-10440	9656	1T15M2	Aluminum	N/A	W01-358-9797	44
NBD-10472	9659	1T15T3	Aluminum	N/A	W01-358-8597	28
NBD-10472	9659	1T15T3	Aluminum	N/A	W01-358-8916	23
NBD-10472	9659	1T15T3	Aluminum	N/A	W01-358-8922	23
NBD-10472	9659	1T15T3	Aluminum	N/A	W01-358-8941	23
NBD-10472	9659	1T15T3	Aluminum	N/A	W01-358-9445	21
NBD-10472	9659	1T15T3	Aluminum	N/A	W01-358-9447	21
NBD-10472	9659	1T15T3	Aluminum	N/A	W01-358-9448	21
NBD-10472	9659	1T15T3	Aluminum	N/A	W01-358-9457	21
NBD-10472	9659	1T15T3	Aluminum	N/A	W01-358-9459	22
NBD-10472	9659	1T15T3	Aluminum	N/A	W01-358-9477	22
NBD-11498	9651	1T14C3	Aluminum	WC1-358-9095	W01-358-2120	12
NBD-11498	9651	1T14C3	Aluminum	WC1-358-9095	W01-358-5343	13
NBD-11498	9651	1T14C3	Aluminum	WC1-358-9095	W01-358-5354	16
NBD-11498	9651	1T14C3	Aluminum	WC1-358-9095	W01-358-5423	14
NBD-11498	9651	1T14C3	Aluminum	WC1-358-9095	W01-358-8868	16
NBD-11689	9754	1T14C7	Aluminum	WC1-358-1603	W01-358-5429	18
NBD-11689	9754	1T14C7	Aluminum	WC1-358-1603	W01-358-5439	16
NBD-11689	9754	1T14C7	Aluminum	WC1-358-1603	W01-358-5702	17
NBD-11689	9754	1T14C7	Aluminum	WC1-358-1603	W01-358-8977	16
NBD-11689	9754	1T14C7	Aluminum	WC1-358-1603	W01-358-8979	17
NBD-12639	9663	1T15L2	Aluminum	N/A	W01-358-9379	27
NBD-12639	9663	1T15	Aluminum	N/A	W01-358-9565	27

PRIMARY TRUCK & TRAILER  
**INDEX BY PISTON DRAWING NUMBER**

PISTON DRAWING NO.	PISTON COMP. NO.	PISTON TYPE	PISTON MATERIALS	PISTON AON	FIRESTONE AON	PAGE NO.
NBD-12639	9663	1T15 2	Aluminum	N/A	W01-358-9566	27
NBD-12639	9663	1T15 2	Aluminum	N/A	W01-358-9567	27
NBD-12639	9663	1T15	Aluminum	N/A	W01-358-9568	28
NBD-14213	9681	1T15Y1	Aluminum	N/A	W01-358-5770	66
NBD-14213	9681	1T15Y1	Aluminum	N/A	W01-358-5772	66
NBD-14213	9681	1T15Y1	Aluminum	N/A	W01-358-5775	66
NBD-14213	9681	1T15Y1	Aluminum	N/A	W01-358-5776	67
NBD-14213	9681	1T15Y1	Aluminum	N/A	W01-358-5777	67
NBD-14213	9681	1T15Y1	Aluminum	N/A	W01-358-5783	67
NBD-14213	9681	1T15Y1	Aluminum	N/A	W01-358-5789	67
NBD-14213	9681	1T15Y1	Aluminum	N/A	W01-358-9586	68
NBD-14404	9528	1T15V1	Composite	WC1-358-0667	W01-358-8737	77
NBD-14404	9528	1T15V1	Composite	WC1-358-0667	W01-358-8738	77
NBD-14404	9528	1T15V1	Composite	WC1-358-0667	W01-358-8991	37
NBD-14404	9528	1T15V1	Composite	WC1-358-0667	W01-358-9249	68
NBD-14404	9528	1T15V1	Composite	WC1-358-0667	W01-358-9578	68
NBD-14404	9528	1T15V1	Composite	WC1-358-0667	W01-358-9582	68
NBD-14503	9691	1T15L4	Aluminum	N/A	W01-358-9415	24
NBD-15201	9538	1T15M6	Composite	WC1-358-1628/ WC1-358-3715	W01-358-9654	54
NBD-15201	9538	1T15M6	Composite	WC1-358-1628/ WC1-358-3715	W01-358-9663	55
NBD-17119	4078	1T15Y1	Aluminum	N/A	W01-358-5770	66
NBD-17119	4078	1T15Y1	Aluminum	N/A	W01-358-5772	66
NBD-17119	4078	1T15Y1	Aluminum	N/A	W01-358-5775	66
NBD-17119	4078	1T15Y1	Aluminum	N/A	W01-358-5776	67
NBD-17119	4078	1T15Y1	Aluminum	N/A	W01-358-5777	67
NBD-17119	4078	1T15Y1	Aluminum	N/A	W01-358-5783	67
NBD-17119	4078	1T15Y1	Aluminum	N/A	W01-358-5789	67
NBD-17119	4078	1T15Y1	Aluminum	N/A	W01-358-9586	68
NDD-3581	9652	1T15M6	Aluminum	N/A	W01-358-9974	53
NDD-3581	9809	1T15L6	Aluminum	N/A	W01-358-9966	50

CAB & SEAT  
BY MANUFACTURER

MANUFACTURER/ PART NO.	FIRESTONE ASSEMBLY ORDER NO.	PAGE NO.
<b>3TS</b>		
	W02-358-7046	130
	W02-358-7100	132
<b>AIR FLEX</b>		
	W02-358-7085	136
<b>DURA FORM</b>		
S13384	W02-358-7150	131
S16894	W02-358-7151	144
S20235	W02-358-7035	138
S20235	W02-358-7108	142
S5388	W02-358-7040	134
S6197	W02-358-4003	141
S8645	W02-358-7041	132
S9383	W02-358-7031	135
S9383	W02-358-7035	138
S9383	W02-358-7108	142
<b>FORD</b>		
F6HT5CO63BA	W02-358-7200	146
F6HT5CO63BA	W02-358-7201	131
<b>FREIGHTLINER</b>		
660033406	W02-358-7205	143
1840977000	W02-358-7215	144
1842609000	W02-358-7200	146
1843472000	W02-358-7204	136
1845068000	W02-358-7201	131
1852651000	W02-358-7215	144
1852651001	W02-358-7215	144
18-29919-000	W02-358-7206	138
18-40977-000	W02-358-7215	144
18-42609-000	W02-358-7200	146
18-45068-000	W02-358-7201	131
1829919999REVC	W02-358-7206	138
	W02-358-7087	138
	W02-358-7200	146
	W02-358-7201	131
	W02-358-7204	136
	W02-358-7205	143
<b>FREIGHTLINER/WESTERN STAR</b>		
	W02-358-7082	143

MANUFACTURER/ PART NO.	FIRESTONE ASSEMBLY ORDER NO.	PAGE NO.
<b>HENDRICKSON</b>		
640752	W26-358-9912	151
663492	W26-358-9913	151
673042	W26-358-9913	151
57QL55M	W26-358-9913	151
59823-2	W26-358-9911	151
598232C	W26-358-9911	151
60750-2	W26-358-9913	151
607502E	W26-358-9913	151
697822A	W26-358-9911	151
H607502	W26-358-9913	151
<b>KENWORTH</b>		
T2000	W02-358-7110	146
<b>KNOEDLER</b>		
9212	W02-358-7040	134
<b>LINK</b>		
11010031	W02-358-7115	137
11020022	W02-358-7046	130
11020025	W02-358-7086	130
11020026	W02-358-7079	130
11020027	W02-358-7098	133
11020030	W02-358-7106	135
11020031	W02-358-7080	136
11020043	W02-358-7056	140
11020047	W02-358-7074	139
11020048	W02-358-7075	138
11020074	W02-358-7064	142
11020075	W02-358-7108	142
11020076	W02-358-7081	145
11020081	W02-358-7083	146
11020083	W02-358-7092	145
11030504	W02-358-9904	141
1101A043	W02-358-7081	145
1102K083	W02-358-7092	145
1103A043	W02-358-7081	145
1104k002	W02-358-7109	142
	W26-358-9902	150

CAB & SEAT  
BY MANUFACTURER

MANUFACTURER/ PART NO.	FIRESTONE ASSEMBLY ORDER NO.	PAGE NO.
11010030	W02-358-7116	137
11010043	W02-358-7081	145
11020021	W02-358-7046	130
11020040	W02-358-7012	139
11020041	W02-358-7042	140
11020042	W02-358-7045	140
11020046	W02-358-7035	138
11020046	W02-358-7108	142
11020070	W02-358-7014	144
11020071	W02-358-7024	143
11020077	W02-358-7109	142
11020082	W02-358-7110	146
1102K077	W02-358-7109	142
1102K082	W02-358-7110	146
R811002	W02-358-7110	146
T811000	W02-358-7109	142
T811001	W02-358-7092	145
<b>MACK</b>		
227QS33	W02-358-7031	135
227QS33	W02-358-7035	138
227QS34	W02-358-7007	136
227QS38	W02-358-7017	141
57QL55M	W26-358-9913	151
<b>NATIONAL SEATING</b>		
2112283	W02-358-7055	134
2123403	W02-358-7070	137
32466201	W02-358-7058	133
32466301	W02-358-7059	132
32803501	W02-358-7059	132
32966601	W02-358-7059	132
329666-01, 328035-01, 324663-01	W02-358-7059	132
W02N197160	W02-358-7070	137
	W02-358-7058	133
<b>PACCAR</b>		
B816023	W26-358-9933	151

MANUFACTURER/ PART NO.	FIRESTONE ASSEMBLY ORDER NO.	PAGE NO.
<b>PETERBILT</b>		
202031	W02-358-9901	141
2902454	W02-358-7036	143
2903200	W02-358-7036	143
2905900	W02-358-7093	145
2906016	W02-358-7093	145
R816000	W02-358-7093	145
R816003	W02-358-7132	132
T816000	W02-358-7036	143
T816002	W02-358-7064	142
<b>SEARS</b>		
S13384	W02-358-7150	131
S16894	W02-358-7151	144
S6197	W02-358-4003	141
S9383	W02-358-7025	137
S9383	W02-358-7035	138
<b>SEATS</b>		
707338	W02-358-7040	134
708015	W02-358-7208	140
708220	W02-358-7209	135
<b>VOLVO</b>		
20462934	W26-358-9913	151
20897204	W26-358-9913	151
660033406	W02-358-7205	143
<b>WATSON &amp; CHALIN</b>		
AS0085	W02-358-7038	142
<b>WISE</b>		
	W02-358-7054	133

CAB & SEAT  
**INDEX BY CAP DRAWING NUMBER**

CAP DRAWING NUMBER	CAP COMPONENT NUMBER	MATERIAL	FIRESTONE AONs	PAGE NO.
FIP-100102	6978	Composite	W02-358-7208	140
NAD-25400	7066	Composite	W02-358-9901	141
NAD-25400	7066	Composite	W02-358-9904	141
NBD-9930	7005	Aluminum	W02-358-7007	136
NBD-10010	7007	Aluminum	W02-358-7010	133
NBD-10010	7007	Aluminum	W02-358-7012	139
NBD-10010	7007	Aluminum	W02-358-7014	144
NBD-10010	7007	Aluminum	W02-358-7017	141
NBD-10010	7007	Aluminum	W02-358-7024	143
NBD-10049	7009	Aluminum	W02-358-4003	141
NBD-10082	7014	Aluminum	W02-358-7002	131
NBD-10082	7014	Aluminum	W02-358-7031	135
NBD-10082	7014	Aluminum	W02-358-7036	143
NBD-10082	7014	Aluminum	W02-358-7139	145
NBD-10183	7013	Aluminum	W02-358-7018	130
NBD-10183	7013	Aluminum	W02-358-7025	137
NBD-10183	7013	Aluminum	W02-358-7037	139
NBD-10183	7013	Aluminum	W02-358-7038	142
NBD-10183	7013	Aluminum	W02-358-7043	144
NBD-10183	7013	Aluminum	W02-358-7073	135
NBD-10183	7013	Aluminum	W02-358-7085	136
NBD-10218	7018	Composite	W02-358-7001	131
NBD-10218	7018	Composite	W02-358-7054	133
NBD-10218	7018	Composite	W02-358-7064	142
NBD-10218	7018	Composite	W02-358-7075	138
NBD-10218	7018	Composite	W02-358-7082	143
NBD-10218	7018	Composite	W02-358-7086	130
NBD-10218	7018	Composite	W02-358-7092	145
NBD-10218	7018	Composite	W02-358-7110	146
NBD-10218	7018	Composite	W02-358-7132	132
NBD-10218	7018	Composite	W02-358-7200	146
NBD-10218	7018	Composite	W02-358-7201	131
NBD-10239	7015	Composite	W02-358-7040	134
NBD-10239	7015	Composite	W02-358-7041	132
NBD-10239	7015	Composite	W02-358-7042	140

CAB & SEAT  
**INDEX BY CAP DRAWING NUMBER**

CAP DRAWING NUMBER	CAP COMPONENT NUMBER	MATERIAL	FIRESTONE AONs	PAGE NO.
NBD-10239	7015	Composite	W02-358-7080	136
NBD-10239	7015	Composite	W02-358-7083	146
NBD-10239	7015	Composite	W02-358-7150	131
NBD-10409	7042	Composite	W02-358-7045	140
NBD-10409	7042	Composite	W02-358-7055	134
NBD-10409	7042	Composite	W02-358-7058	133
NBD-10409	7042	Composite	W02-358-7059	132
NBD-10409	7042	Composite	W02-358-7061	139
NBD-10409	7042	Composite	W02-358-7070	137
NBD-10409	7042	Composite	W02-358-7087	138
NBD-10409	7042	Composite	W02-358-7209	135
NBD-10470	7068	Composite	W02-358-7035	138
NBD-10470	7068	Composite	W02-358-7046	130
NBD-10470	7068	Composite	W02-358-7049	134
NBD-10470	7068	Composite	W02-358-7100	132
NBD-10470	7068	Composite	W02-358-7108	142
NBD-10470	7068	Composite	W02-358-7149	134
NBD-10470	7068	Composite	W02-358-7151	144
NBD-10604	7050	Composite	W02-358-7081	145
NBD-10604	7050	Composite	W02-358-7115	137
NBD-10604	7050	Composite	W02-358-7116	137
NBD-11636	7074	Composite	W02-358-7079	130
NBD-13262	6997	Composite	W02-358-7056	140
NBD-13262	6997	Composite	W02-358-7074	139
NBD-13262	6997	Composite	W02-358-7098	133
NBD-13262	6997	Composite	W02-358-7106	135
NBD-13706	6990	Composite	W02-358-7109	142
NBD-13706	6990	Composite	W02-358-7204	136
NBD-14314	6991	Composite	W02-358-7093	145
NBD-15430	6987	Composite	W02-358-7205	143
NBD-15430	6987	Composite	W02-358-7206	138
NBD-15430	6987	Composite	W02-358-7215	144

CAB & SEAT  
**INDEX BY PISTON DRAWING NUMBER**

PISTON DRAWING NUMBER	PISTON COMPONENT NUMBER	MATERIAL	FIRESTONE AON	PAGE NO.
FIP-100105	6979	Composite	W02-358-7209	135
FIP-102215	9637	Composite	W02-358-7055	134
FIP-102215	9637	Composite	W02-358-7056	140
FIP-102215	9637	Composite	W02-358-7106	135
FIP-102215	9637	Composite	W02-358-7110	146
FIP-102216	9638	Composite	W02-358-7045	140
FIP-102216	9638	Composite	W02-358-7054	133
FIP-102216	9638	Composite	W02-358-7074	139
FIP-102216	9638	Composite	W02-358-7098	133
FIP-102217	9636	Composite	W02-358-7040	134
FIP-102217	9636	Composite	W02-358-7041	132
FIP-102217	9636	Composite	W02-358-7042	140
FIP-102217	9636	Composite	W02-358-7049	134
FIP-102217	9636	Composite	W02-358-7080	136
FIP-102217	9636	Composite	W02-358-7081	145
FIP-102217	9636	Composite	W02-358-7083	146
FIP-102217	9636	Composite	W02-358-7116	137
FIP-102217	9636	Composite	W02-358-7151	144
FIP-102217	9636	Composite	W02-358-7208	140
NBD-10071	7023	Aluminum	W02-358-7010	133
NBD-10071	7023	Aluminum	W02-358-7012	139
NBD-10071	7023	Aluminum	W02-358-7014	144
NBD-10071	7023	Aluminum	W02-358-7017	141
NBD-10071	7023	Aluminum	W02-358-7024	143
NBD-10071	7023	Aluminum	W02-358-7043	144
NBD-10071	7023	Aluminum	W02-358-7073	135
NBD-10071	7023	Aluminum	W02-358-7085	136
NBD-10215 (replaced by FIP-102216)				
NBD-10238 (replaced by FIP-102217)				
NBD-10514	7044	Aluminum	W02-358-4003	141
NBD-10526 (replaced by FIP-102215)				
NBD-10549	7049	Aluminum	W02-358-7002	131
NBD-10549	7049	Aluminum	W02-358-7007	136
NBD-10549	7049	Aluminum	W02-358-7031	135
NBD-10552 (replaced by NBD-16538)				
NBD-10795	7054	Aluminum	W02-358-7018	130
NBD-10795	7054	Aluminum	W02-358-7025	137
NBD-10795	7054	Aluminum	W02-358-7037	139

CAB & SEAT  
**INDEX BY PISTON DRAWING NUMBER**

PISTON DRAWING NUMBER	PISTON COMPONENT NUMBER	MATERIAL	FIRESTONE AON	PAGE NO.
NBD-10795	7054	Aluminum	W02-358-7038	142
NBD-11340	7059	Composite	W02-358-9901	141
NBD-12708	6896	Composite	W02-358-7058	133
NBD-12708	6896	Composite	W02-358-7059	132
NBD-12708	6896	Composite	W02-358-7149	134
NBD-12802 (replaced by NBD-16536)				
NBD-12816 (replaced by NBD-16484)				
NBD-13499 (replaced by NBD-16510)				
NBD-13727 (replaced by NBD-16537)				
NBD-14218	6894	Composite	W02-358-7109	142
NBD-14589	6891	Composite	W02-358-7093	145
NBD-15431	6986	Composite	W02-358-7205	143
NBD-15431	6986	Composite	W02-358-7206	138
NBD-15431	6986	Composite	W02-358-7215	144
NBD-15764	6980	Composite	W02-358-9904	141
NBD-16484	6906	Aluminum	W02-358-7036	143
NBD-16484	6906	Aluminum	W02-358-7139	145
NBD-16510	6908	Composite	W02-358-7132	132
NBD-16536	6911	Composite	W02-358-7070	137
NBD-16536	6911	Composite	W02-358-7087	138
NBD-16537	6912	Composite	W02-358-7035	138
NBD-16537	6912	Composite	W02-358-7046	130
NBD-16537	6912	Composite	W02-358-7079	130
NBD-16537	6912	Composite	W02-358-7100	132
NBD-16537	6912	Composite	W02-358-7108	142
NBD-16537	6912	Composite	W02-358-7115	137
NBD-16537	6912	Composite	W02-358-7150	131
NBD-16538	6913	Composite	W02-358-7001	131
NBD-16538	6913	Composite	W02-358-7061	139
NBD-16538	6913	Composite	W02-358-7064	142
NBD-16538	6913	Composite	W02-358-7075	138
NBD-16538	6913	Composite	W02-358-7082	143
NBD-16538	6913	Composite	W02-358-7086	130
NBD-16538	6913	Composite	W02-358-7092	145
NBD-16538	6913	Composite	W02-358-7200	146
NBD-16538	6913	Composite	W02-358-7201	131
NBD-16538	6913	Composite	W02-358-7204	136

CAB &amp; SEAT

## INDEX BY CAP COMPONENT NUMBER

CAP COMPONENT NUMBER	CAP DRAWING NUMBER	MATERIAL	FIRESTONE AON	PAGE NUMBER
6978	FIP-100102	Composite	W02-358-7208	140
6987	NBD-15430	Composite	W02-358-7205	143
6987	NBD-15430	Composite	W02-358-7206	138
6987	NBD-15430	Composite	W02-358-7215	144
6990	NBD-13706	Composite	W02-358-7109	142
6991	NBD-14314	Composite	W02-358-7093	145
6997	NBD-13262	Composite	W02-358-7056	140
6997	NBD-13262	Composite	W02-358-7074	139
6997	NBD-13262	Composite	W02-358-7106	135
7005	NBD-9930	Aluminum	W02-358-7007	136
7007	NBD-10010	Aluminum	W02-358-7010	133
7007	NBD-10010	Aluminum	W02-358-7012	139
7007	NBD-10010	Aluminum	W02-358-7014	144
7007	NBD-10010	Aluminum	W02-358-7017	141
7007	NBD-10010	Aluminum	W02-358-7024	143
7009	NBD-10049	Aluminum	W02-358-4003	141
7013	NBD-10183	Aluminum	W02-358-7018	130
7013	NBD-10183	Aluminum	W02-358-7025	137
7013	NBD-10183	Aluminum	W02-358-7038	142
7013	NBD-10183	Aluminum	W02-358-7085	136
7014	NBD-10082	Aluminum	W02-358-7002	131
7014	NBD-10082	Aluminum	W02-358-7031	135
7014	NBD-10082	Aluminum	W02-358-7036	143
7014	NBD-10082	Aluminum	W02-358-7139	145
7015	NBD-10239	Composite	W02-358-7040	134
7015	NBD-10239	Composite	W02-358-7041	132
7015	NBD-10239	Composite	W02-358-7042	140
7015	NBD-10239	Composite	W02-358-7080	136
7015	NBD-10239	Composite	W02-358-7083	146
7015	NBD-10239	Composite	W02-358-7150	131
7018	NBD-10218	Composite	W02-358-7001	131
7018	NBD-10218	Composite	W02-358-7054	133
7018	NBD-10218	Composite	W02-358-7064	142
7018	NBD-10218	Composite	W02-358-7075	138
7018	NBD-10218	Composite	W02-358-7082	143

CAB &amp; SEAT

## INDEX BY CAP COMPONENT NUMBER

CAP COMPONENT NUMBER	CAP DRAWING NUMBER	MATERIAL	FIRESTONE AON	PAGE NUMBER
7018	NBD-10218	Composite	W02-358-7086	130
7018	NBD-10218	Composite	W02-358-7092	145
7018	NBD-10218	Composite	W02-358-7110	146
7018	NBD-10218	Composite	W02-358-7132	132
7018	NBD-10218	Composite	W02-358-7200	146
7018	NBD-10218	Composite	W02-358-7201	131
7042	NBD-10409	Composite	W02-358-7045	140
7042	NBD-10409	Composite	W02-358-7055	134
7042	NBD-10409	Composite	W02-358-7058	133
7042	NBD-10409	Composite	W02-358-7059	132
7042	NBD-10409	Composite	W02-358-7061	139
7042	NBD-10409	Composite	W02-358-7070	137
7042	NBD-10409	Composite	W02-358-7087	138
7050	NBD-10604	Composite	W02-358-7081	145
7050	NBD-10604	Composite	W02-358-7115	137
7050	NBD-10604	Composite	W02-358-7116	137
7066	NAD-25400	Composite	W02-358-9901	141
7066	NAD-25400	Composite	W02-358-9904	141
7068	NBD-10470	Composite	W02-358-7035	138
7068	NBD-10470	Composite	W02-358-7046	130
7068	NBD-10470	Composite	W02-358-7100	132
7068	NBD-10470	Composite	W02-358-7108	142
7068	NBD-10470	Composite	W02-358-7149	134
7068	NBD-10470	Composite	W02-358-7151	144
7074	NBD-11636	Composite	W02-358-7079	130
6990	NBD-13706	Composite	W02-358-7204	136
6997	NBD-13262	Composite	W02-358-7098	133
7013	NBD-10183	Aluminum	W02-358-7037	139
7013	NBD-10183	Aluminum	W02-358-7043	144
7013	NBD-10183	Aluminum	W02-358-7073	135
7042	NBD-10409	Composite	W02-358-7209	135
7068	NBD-10470	Composite	W02-358-7049	134



CAB & SEAT

**INDEX BY PISTON COMPONENT NUMBER**

PISTON COMPONENT NUMBER	PISTON DRAWING NUMBER	MATERIAL	FIRESTONE AON	PAGE NUMBER
6891	NBD-14589	Composite	W02-358-7093	145
6894	NBD-14218	Composite	W02-358-7109	142
6896	NBD-12708	Composite	W02-358-7058	133
6896	NBD-12708	Composite	W02-358-7059	132
6896	NBD-12708	Composite	W02-358-7149	134
6906	NBD-16484	Aluminum	W02-358-7036	143
6906	NBD-16484	Aluminum	W02-358-7139	145
6908	NBD-16510	Composite	W02-358-7132	132
6911	NBD-16536	Composite	W02-358-7070	137
6911	NBD-16536	Composite	W02-358-7087	138
6912	NBD-16537	Composite	W02-358-7035	138
6912	NBD-16537	Composite	W02-358-7046	130
6912	NBD-16537	Composite	W02-358-7079	130
6912	NBD-16537	Composite	W02-358-7100	132
6912	NBD-16537	Composite	W02-358-7108	142
6912	NBD-16537	Composite	W02-358-7115	137
6912	NBD-16537	Composite	W02-358-7150	131
6913	NBD-16538	Composite	W02-358-7001	131
6913	NBD-16538	Composite	W02-358-7061	139
6913	NBD-16538	Composite	W02-358-7064	142
6913	NBD-16538	Composite	W02-358-7075	138
6913	NBD-16538	Composite	W02-358-7082	143
6913	NBD-16538	Composite	W02-358-7086	130
6913	NBD-16538	Composite	W02-358-7092	145
6913	NBD-16538	Composite	W02-358-7200	146
6913	NBD-16538	Composite	W02-358-7201	131
6913	NBD-16538	Composite	W02-358-7204	136
6979	FIP-100105	Composite	W02-358-7209	135
6980	NBD-15764	Composite	W02-358-9904	141
6986	NBD-15431	Composite	W02-358-7205	143
6986	NBD-15431	Composite	W02-358-7206	138
6986	NBD-15431	Composite	W02-358-7215	144
6996 (replaced by 6908)				
6998 (replaced by 6911)				
7023	NBD-10071	Aluminum	W02-358-7010	133
7023	NBD-10071	Aluminum	W02-358-7012	139
7023	NBD-10071	Aluminum	W02-358-7014	144
7023	NBD-10071	Aluminum	W02-358-7017	141

CAB & SEAT

**INDEX BY PISTON COMPONENT NUMBER**

PISTON COMPONENT NUMBER	PISTON DRAWING NUMBER	MATERIAL	FIRESTONE AON	PAGE NUMBER
7023	NBD-10071	Aluminum	W02-358-7024	143
7023	NBD-10071	Aluminum	W02-358-7043	144
7023	NBD-10071	Aluminum	W02-358-7073	135
7023	NBD-10071	Aluminum	W02-358-7085	136
7033 (replaced by 9636)				
7041 (replaced by 9638)				
7044	NBD-10514	Aluminum	W02-358-4003	141
7047 (replaced by 9637)				
7049	NBD-10549	Aluminum	W02-358-7002	131
7049	NBD-10549	Aluminum	W02-358-7007	136
7049	NBD-10549	Aluminum	W02-358-7031	135
7052 (replaced by 6913)				
7054	NBD-10795	Aluminum	W02-358-7018	130
7054	NBD-10795	Aluminum	W02-358-7025	137
7054	NBD-10795	Aluminum	W02-358-7037	139
7054	NBD-10795	Aluminum	W02-358-7038	142
7059	NBD-11340	Composite	W02-358-9901	141
7069 (replaced by 6906)				
7083 (replaced by 6912)				
9636	FIP-102217	Composite	W02-358-7040	134
9636	FIP-102217	Composite	W02-358-7041	132
9636	FIP-102217	Composite	W02-358-7042	140
9636	FIP-102217	Composite	W02-358-7049	134
9636	FIP-102217	Composite	W02-358-7080	136
9636	FIP-102217	Composite	W02-358-7081	145
9636	FIP-102217	Composite	W02-358-7083	146
9636	FIP-102217	Composite	W02-358-7116	137
9636	FIP-102217	Composite	W02-358-7151	144
9636	FIP-102217	Composite	W02-358-7208	140
9637	FIP-102215	Composite	W02-358-7055	134
9637	FIP-102215	Composite	W02-358-7056	140
9637	FIP-102215	Composite	W02-358-7106	135
9637	FIP-102215	Composite	W02-358-7110	146
9638	FIP-102216	Composite	W02-358-7045	140
9638	FIP-102216	Composite	W02-358-7054	133
9638	FIP-102216	Composite	W02-358-7074	139
9638	FIP-102216	Composite	W02-358-7098	133

## OE SUSPENSION INDEX

MANUFACTURER NAME PART NUMBER	FIRESTONE AON	PAGE NO.
<b>HENDRICKSON AUXILIARY HLM SERIES</b>		
<b>HL-015</b>		
(Ride)	W01-358-8050	91
(Lift)	W01-358-7403	110
<b>HLM-1&amp;2</b>		
(Ride)	W01-358-9367	60
(Lift)	W01-358-6935	101
<b>MTL-45 &amp; 50</b>		
(Ride)	W01-358-9367	60
(Lift)	W01-358-6902	99
<b>HENDRICKSON AUXILIARY HLN SERIES</b>		
<b>HLN (Truck)</b>		
(Ride)	W01-358-8033	122
(Lift)	W01-358-7795	102
<b>HLN (Trailer)</b>		
(Ride)	W01-358-8042	127
(Lift)	W01-358-7795	102
<b>HENDRICKSON AUXILIARY HLP SERIES</b>		
<b>HLP</b>		
(Ride)	W01-358-8033	122
(Lift)	W01-358-7795	102
<b>HLP (Trailer)</b>		
(Ride)	W01-358-8042	127
(Lift)	W01-358-7795	102
<b>HENDRICKSON AUXILIARY HLQ SERIES</b>		
QS16A-X	W01-358-7403	110
QT20A-X		Call us
QU22C-X&QU22D-X	W01-358-9105	38
QW12A-X	W01-358-7136	106
<b>HENDRICKSON AUXILIARY HLR SERIES</b>		
<b>ST-004</b>		
(Ride)	W01-358-7843	125
(Lift)	W01-358-6902	99

MANUFACTURER NAME PART NUMBER	FIRESTONE AON	PAGE NO.
<b>ST-031</b>		
(Ride)	W01-358-7846	125
(Lift)	W01-358-6902	99
<b>RT14D-X (Truck)</b>		
(Ride)	W01-358-7847	125
(Lift)	W01-358-7403	110
<b>RW14A-X</b>		
(Ride)	W01-358-7843	125
(Lift)	W01-358-6902	99
<b>RW14B-X&amp;14C-X (trailer)</b>		
(Ride)	W01-358-7847	125
(Lift)	W01-358-7403	110
<b>HENDRICKSON AUXILIARY HLU SERIES</b>		
<b>HLU</b>		
(Ride)	W01-358-8033	122
(Lift)	W01-358-7795	102
<b>HLUS</b>		
(Ride)	W01-358-8033	122
(Lift)	W01-358-7795	102
<b>HLUH (ultra high lift)</b>		
(Ride)	W01-358-7862	126
(Lift)	W01-358-7545	116
<b>HLUR (pararev)</b>		
(Ride)	W01-358-8033	122
(Lift)	W01-358-7897	103
<b>HENDRICKSON TRAILER T-SERIES</b>		
T-15-140, 150, 172, 244, 376	W01-358-8050	91
T-15-324	W01-358-8050	91
T-17-141, 174, 284	W01-358-8050	91
T-30-US-9,17	W01-358-9122	85
T-4-392	W01-358-9010	41
T-6-062	W01-358-9039	34
T-6-071	W01-358-9105	38
T-6-295	W01-358-9039	34

## OE SUSPENSION INDEX

MANUFACTURER NAME PART NUMBER	FIRESTONE AON	PAGE NO.
T-6-370	W01-358-9039	34
T-6-422	W01-358-9039	34
T-9-084	W01-358-9122	85
T-9-106,278,313	W01-358-9082	46
T-9-175	W01-358-9158	86
T-9-325	W01-358-9092	46
T-9-390	W01-358-9092	46
TDC-014	W01-358-9039	34
TMB-14-120	W01-358-9082	46
TMB-17-135	W01-358-9082	46
<b>HENDRICKSON TRAILER HT-SERIES</b>		
HT190T	W01-358-9640	63
HT190U	W01-358-8944	61
HT230T	W01-358-9270	71
HT250T	W01-358-9265	61
HT250U	W01-358-9265	61
HT250U"Y"	W01-358-9265	61
HT-250U	W01-358-9299	64
HT-250U-Y (majority of versions)	W01-358-9265	61
HT-250U-Y	W01-358-9580	79
HT-250US	W01-358-9580	79
HT-250US	W01-358-9265	61
HT-250US	W01-358-9299	64
HT-300T (all)	W01-358-8050	91
HT-300U (all)	W01-358-9122	85
<b>HENDRICKSON TRAILER INTRAAX SERIES</b>		
AA230T	W01-358-8709	78
AA250T (reuse metal disk)	W01-358-8091	89
AA230L	W01-358-9626	25
AA230L	W01-358-9621	27
AA230L	W01-358-9619	28
AA250L	W01-358-9644	61
AA250L	W01-358-9646	61
AA250L	W01-358-9645	61

MANUFACTURER NAME PART NUMBER	FIRESTONE AON	PAGE NO.
<b>HENDRICKSON TRAILER HT DOLLY</b>		
HT Dolly	W01-358-9640	63
HT Dolly	W01-358-9270	71
<b>HENDRICKSON TRAILER SLIDER BOX</b>		
HS-190T	W01-358-9640	63
HS-230	W01-358-9270	71
HK-190T	W01-358-8755	75
HK-230	W01-358-8756	Call us
<b>HENDRICKSON TRAILER VAN TRAAX</b>		
HKA-180	W01-358-8713	78
HKA-180	W01-358-8709	78
HKA-200	W01-358-8708	78
HKA-250 (reuse metal disk)	W01-358-8091	89
<b>HENDRICKSON TRAILER LIFTS</b>		
CL	W01-358-7136	106
CL	W01-358-6801	107
HTCL	W01-358-7447	112
<b>HENDRICKSON TRUCK</b>		
<b>HA360</b>		
(up to 1991)	W01-358-9466	49
(1991 and up)	W01-358-9287	53
<b>HA400</b>		
(up to 1991)	W01-358-9466	49
(1991 and up)	W01-358-9287	53
<b>HA460</b>		
(up to 1991)	W01-358-9466	49
(1991 and up)	W01-358-9287	53
HAS40LH	W01-358-9297	53
HAS360	W01-358-9373	53
HAS400	W01-358-9373	53
HAS402	W01-358-9373	53
HAS460	W01-358-9373	53
AIRTEK 12K/12.6K/14.6K	W01-358-8597	28
PAX460	W01-358-9663	55

OE SUSPENSION INDEX

MANUFACTURER NAME PART NUMBER	FIRESTONE AON	PAGE NO.
<b>HOLLAND LIFT SUSPENSIONS</b>		
AL-40-US (Lift)	W01-358-7424	111
AL-41, AL-41-US (Lift)	W01-358-7424	111
AL-42, AL-42-US (Lift)	W01-358-7424	111
AL-45-9, 12, 14, 17 (Lift)	W01-358-7424	111
AL-50, AL-50US (Lift)	W01-358-7424	111
AL-70, AL-70-US (Lift)	W01-358-7424	111
AL-75-B, AL-76-A, AL-77, AL-78 (Lift)	W01-358-7135	106
ALT-40, ALT-40-L (Lift)	W01-358-7424	111
ALT-40-US, ALT-50-US, ALT-70-US (Lift)	W01-358-7424	111
ALT-500-US, ALT-550-US (Lift)	W01-358-7135	106
<b>HOLLAND TRAILER AIR</b>		
AR-41, AR-45, AR-45-1	W01-358-9039	34
AR-50-US, -F, -F-1, -F-2, AR-51-US	W01-358-9039	34
AR-70-9, AR-70-14	W01-358-9121	82
AR-70A-9, -14	W01-358-9121	82
AR-75-12, 1-12	W01-358-9101	57
AR-75-12, 1-12	W01-358-9346	59
AR-75-6, -9	W01-358-9082	46
AR-80-6.75	W01-358-9121	82
AR-80-9	W01-358-9134	84
AR-80-9FM	W01-358-9138	85
AR-80-9-WST	W01-358-9134	84
AR-85-A	W01-358-9121	82
AR-90-1-12	W01-358-9463	Call us
AR-90-1-14, 17	W01-358-9362	49
AR-90-1-15, 16	W01-358-9304	49
AR-90-14,15,16,17	W01-358-9243	58
AR-92-12, 14	W01-358-9921	51
AR-92-15	W01-358-9921	51
AR-92-16	W01-358-9921	51
AR-92-17	W01-358-9921	51
AR-92-18	W01-358-9921	51

MANUFACTURER NAME PART NUMBER	FIRESTONE AON	PAGE NO.
AR-93-14	W01-358-9921	51
AR-93-15	W01-358-9923	51
AR-93-16	W01-358-9923	51
AR-93-17	W01-358-9922	51
AR-120	W01-358-9082	46
AR-120-L	W01-358-9101	57
AR-120-US	W01-358-9082	46
AR-120-US-F	W01-358-9082	46
AR-120-US-L1,2,3	W01-358-9101	57
AR-125	W01-358-9177	83
AR-125-L	W01-358-9158	86
AR-125-US	W01-358-9177	83
AR-125-US-F	W01-358-9121	82
AR-125-US-L1,2,3	W01-358-9158	86
AR-165-US	W01-358-9082	46
AR-955-9, 12, 14, 17	W01-358-9122	85
AR-955-9-HD, 12-HD, 14-HD, 17-HD	W01-358-9122	85
AR-955A-9, 12, 14, 17	W01-358-9122	85
AR-955A-9-HD, 12-HD, 14-HD, 17-HD	W01-358-9122	85
AR-95-9,12,14,17	W01-358-9122	85
AR-95-9-HD, 12-HD, 14-HD, 17-HD	W01-358-9122	85
AR-95A-9,-12, -14, -17	W01-358-9122	85
AR-95A-9-HD, 12-HD, 14-HD, 17-HD	W01-358-9122	85
ARDST-246	W01-358-9121	82
ARL-20-D	W01-358-7437	111
ARL-20-D	W01-358-9039	34
ARL-20-D-US	W01-358-7437	111
ARL-20-D-US	W01-358-9039	34
ARU-92-10	W01-358-9243	58
ARU-92-8	W01-358-9921	51
ARU-92-9	W01-358-9243	58
ARU-93-6	W01-358-9921	51
ARU-93-7	W01-358-9921	51

OE SUSPENSION INDEX

MANUFACTURER NAME PART NUMBER	FIRESTONE AON	PAGE NO.
CB-2300	W01-358-9974	53
NS190	W01-358-9366	39
NS190-16	W01-358-8204	36
RL-196-12	W01-358-9294	32
RL-196-14	W01-358-9293	32
RL-196-15	W01-358-9295	33
RL-196-16	W01-358-9295	33
RL-196-17	W01-358-9291	32
RL-196A-14	W01-358-9293	32
RL-196A-15	W01-358-9295	33
RL-196A-16	W01-358-9295	33
RL-300	W01-358-8764	Call us
RL228-14, 15, 16	W01-358-9936	52
RL228-17	W01-358-8749	76
RL250-12,	W01-358-8749	76
RL250-14,15	W01-358-8748	76
RL250-16, 17	W01-358-8749	76
RLU-228 (12) -4	W01-358-9346	59
RLU-228 (6,7) -3	W01-358-9921	51
RLU-228 (8) -3	W01-358-9923	51
RLU-228 (8) -4	W01-358-9921	51
RLU-228 (9,10) -3	W01-358-9922	51
RLU-228 (9,10) -4	W01-358-9243	58
RLU-250 (12)	W01-358-8744	75
RLU-250 (6.75,9)	W01-358-8746	75
Intermodel	W01-358-9896	88
<b>HOLLAND POWERED TRUCK</b>		
AD-123,246(6.5,8.75)	W01-358-9472	69
AD-123,246(10)	W01-358-9471	69
AD-123,246(FORD)	W01-358-9472	69
AD-123	W01-358-9502	70
AD-123	W01-358-9501	70
AD-200(7)	W01-358-9482	43
AD-200(9)	W01-358-9496	50

MANUFACTURER NAME PART NUMBER	FIRESTONE AON	PAGE NO.
AD-200(11)	W01-358-9471	69
ADTB	W01-358-9697	44
ARDST-123/244-6	W01-358-9082	46
ARDST-244-6	W01-358-9193	47
ARDST-246-6, ARDST- M/L-246-6	W01-358-9121	82
ARDTB-125-6A	W01-358-8053	91
ARDAB-120-5, 240-5	W01-358-9268	63
ARD-120-6, ARD-238-6	W01-358-9082	46
ARD-125-6, 244-6	W01-358-9093	47
ARD-125-6, 244-6	W01-358-9082	46
ARD-125, -8, 244-8	W01-358-9082	46
ARD-165-A	W01-358-9082	46
ARD-165-B	W01-358-9082	46
ARD-190-B	W01-358-9082	46
ARL-20-D, -US	W01-358-7437	111
ARL-20-D, -US	W01-358-9039	34
<b>HOLLAND NON-POWERED TRUCK</b>		
ART-500-B, -B1	W01-358-9082	46
ART-500-US-A	W01-358-9082	46
ART-505-B, B-1	W01-358-9082	46
ART-505-C, C-1	W01-358-9082	46
ART-541-B	W01-358-9082	46
ART-550-US	W01-358-9082	46
ART-551-B-1, -2, -3	W01-358-9101	57
ART-551-US-1, -2, -3	W01-358-9101	57
ART-555-B-1, -2, -3	W01-358-9101	57
ART-555-C-1, -2, -3	W01-358-9101	57
IFS-114	W01-358-8198	36
TC-120-D	W01-358-9082	46
TC-120-D, -44	W01-358-9177	83

## OE SUSPENSION INDEX

MANUFACTURER NAME PART NUMBER	FIRESTONE AON	PAGE NO.
<b>WATSON CHALIN STEERING LIFTABLES</b>		
<b>LWSTL-1100</b>		
(Ride)	W01-358-8008	120
(Lift)	W01-358-6897	99
<b>STL-1100 TRU-TRACK</b>		
(Ride)	W01-358-8032	122
(Lift)	W01-358-6897	99
<b>STL-1800</b>		
(Ride)	W01-358-7798	123
(Lift)	W01-358-6897	99
<b>WATSON CHALIN TRAILER</b>		
TA-250-14,15,16,17	W01-358-8753	74
TA-250U-12	W01-358-9243	58
TA-250U-14	W01-358-9243	58
TA-250U-5.5	W01-358-9243	58
TA-250U-7.5	W01-358-9243	58
TA-250U-7.5FS	W01-358-9243	58
TA-250U-9	W01-358-9243	58
TA-251-10	W01-358-9243	58
TA-251-12	W01-358-9243	58
TA-251-6.5FS	W01-358-9243	58
TA-251-7.5	W01-358-9243	58
TA-251-8FS	W01-358-9243	58
TA-251-9.0	W01-358-9243	58
TA-251-9.0 FS	W01-358-9243	58
TA-2590-12,14,15	W01-358-9243	58
TA-280-7.5	W01-358-9243	58
TA-280-9.0	W01-358-9243	58
TA-280D	W01-358-9039	34
TA-300-15	W01-358-8050	91
TA-300-16/17	W01-358-8050	91
TA-300-17	W01-358-8050	91
TA-300-22	W01-358-8050	91
TA-300-23B	W01-358-8050	91

MANUFACTURER NAME PART NUMBER	FIRESTONE AON	PAGE NO.
TA-300-9	W01-358-9121	82
TA-300FM-16B	W01-358-8050	91
TA-300U-12	W01-358-9122	85
TA-300U-14	W01-358-9122	85
TA-300U-17	W01-358-9122	85
TA-300U-9	W01-358-9122	85
TA-3090-14	W01-358-9121	82
TA-3090-17	W01-358-9122	85
TA-3090-19	W01-358-9122	85
TA-5000-DB-24	W01-358-8050	91
TA-5000-DB-30	W01-358-8050	91
TA-5000-F-24	W01-358-8050	91
TA-525DB	W01-358-8050	91
TA-525FS	W01-358-8050	91
TA-791	W01-358-9921	51
TA-791-17-B	W01-358-9243	58
TA-2075 (12)	W01-358-9101	57
TA-2075-9	W01-358-9082	46
<b>WATSON CHALIN LIFTABLES</b>		
<b>TL-1100</b>		
(Lift)	W01-358-6897	99
<b>TL-2200-23 thru 34</b>		
(Ride)	W01-358-9370	60
(Lift)	W01-358-6897	99
<b>TL-2200-9 thru 20</b>		
(Ride)	W01-358-9370	60
(Lift)	W01-358-6897	99
<b>TL-2200LP</b>		
(Lift)	W01-358-6897	99
(Ride)	W01-358-9243	58
<b>TL-2200-SSR</b>		
(Ride)	W01-358-9370	60
(Lift)	W01-358-6897	99

## OE SUSPENSION INDEX

MANUFACTURER NAME PART NUMBER	FIRESTONE AON	PAGE NO.
TL-2590-12,14,15	W01-358-9243	58
TL-2590-14,17 HD	W01-358-9243	58
TL-2700-HD-14-ES	W01-358-6943	104
TL-800 (Ride)	W01-358-8032	122
<b>TL-8100</b>		
(Ride)	W01-358-8032	122
(Lift)	W01-358-6897	99
<b>TL-9000-16B</b>		
(Ride)	W01-358-8008	120
(Lift)	W01-358-6897	99
<b>TL-9000-17.5/16.5</b>		
(Ride)	W01-358-8008	120
(Lift)	W01-358-6897	99
<b>TL-9000-19</b>		
(Ride)	W01-358-8008	120
(Lift)	W01-358-6897	99
<b>TL-9000-21</b>		
(Ride)	W01-358-8008	120
(Lift)	W01-358-6897	99
TL-9000-24 (Ride)	W01-358-8008	120
<b>TL-9000-30</b>		
(Ride)	W01-358-8008	120
(Lift)	W01-358-6897	99
TLC-2590-12,14,15	W01-358-9243	58
<b>TRU-TRACK</b>		
(Ride)	W01-358-8008	120
(Lift)	W01-358-6897	99
WB-2500-6	W01-358-9105	38
WB-2500-7.5	W01-358-9082	46
WB-2500-9	W01-358-9082	46
WB-251-7.5	W01-358-9243	58
WB-251-9.0	W01-358-9243	58
WB-280-9.0	W01-358-9243	58

MANUFACTURER NAME PART NUMBER	FIRESTONE AON	PAGE NO.
<b>WATSON CHALIN TRUCK</b>		
<b>AL-2200, -LW, -SSR, -RO</b>		
(Lift)	W01-358-9219	48
(Ride)	W01-358-6897	99
<b>SL-2200-13.5, -15</b>		
(Lift)	W01-358-9370	60
(Ride)	W01-358-6897	99
<b>AL-2200-LP</b>		
(Lift)	W01-358-9370	60
(Ride)	W01-358-6897	99
<b>AL-2200 ES</b>		
(Ride)	W01-358-6897	99
<b>AS-0048</b>		
(Ride)	W01-358-7990	119

ALL PARTS  
**INDEX BY ASSEMBLY ORDER NUMBER**

FIRESTONE AON	PAGE NO.	FIRESTONE AON	PAGE NO.
W01-358-0510	96	W01-358-5434	15
W01-358-0742	40	W01-358-5439	16
W01-358-0783	55	W01-358-5503	86
W01-358-1096	45	W01-358-5505	87
W01-358-1190	73	W01-358-5508	87
W01-358-1191	73	W01-358-5511	87
W01-358-1192	73	W01-358-5514	87
W01-358-2119	12	W01-358-5523	90
W01-358-2120	12	W01-358-5530	90
W01-358-2131	12	W01-358-5702	17
W01-358-3400	116	W01-358-5710	17
W01-358-3402	116	W01-358-5712	17
W01-358-3406	116	W01-358-5730	16
W01-358-3420	118	W01-358-5766	65
W01-358-5297	18	W01-358-5770	66
W01-358-5298	18	W01-358-5772	66
W01-358-5310	12	W01-358-5775	66
W01-358-5311	12	W01-358-5776	67
W01-358-5319	18	W01-358-5777	67
W01-358-5323	13	W01-358-5783	67
W01-358-5335	15	W01-358-5789	67
W01-358-5336	15	W01-358-5792	67
W01-358-5343	13	W01-358-5900	103
W01-358-5345	15	W01-358-6215	118
W01-358-5354	16	W01-358-6231	62
W01-358-5379	18	W01-358-6258	71
W01-358-5405	13	W01-358-6262	62
W01-358-5406	13	W01-358-6392	103
W01-358-5408	13	W01-358-6799	117
W01-358-5410	14	W01-358-6800	107
W01-358-5412	14	W01-358-6801	107
W01-358-5414	14	W01-358-6802	107
W01-358-5422	14	W01-358-6803	107
W01-358-5423	14	W01-358-6805	108
W01-358-5426	17	W01-358-6808	108
W01-358-5429	18	W01-358-6817	103

ALL PARTS  
**INDEX BY ASSEMBLY ORDER NUMBER**

FIRESTONE AON	PAGE NO.	FIRESTONE AON	PAGE NO.	FIRESTONE AON	PAGE NO.
W01-358-7094	98	W01-358-6831	118	W01-358-7424	111
W01-358-7103	97	W01-358-6856	98	W01-358-7429	111
W01-358-7104	97	W01-358-6883	102	W01-358-7437	111
W01-358-7112	98	W01-358-6884	99	W01-358-7443	112
W01-358-7123	105	W01-358-6886	103	W01-358-7444	112
W01-358-7135	106	W01-358-6890	99	W01-358-7446	112
W01-358-7136	106	W01-358-6897	99	W01-358-7447	112
W01-358-7140	106	W01-358-6900	99	W01-358-7462	98
W01-358-7145	106	W01-358-6902	99	W01-358-7472	116
W01-358-7146	106	W01-358-6905	100	W01-358-7473	112
W01-358-7180	108	W01-358-6908	100	W01-358-7504	113
W01-358-7181	108	W01-358-6910	100	W01-358-7505	114
W01-358-7183	109	W01-358-6926	100	W01-358-7512	114
W01-358-7185	109	W01-358-6927	104	W01-358-7545	116
W01-358-7230	115	W01-358-6932	100	W01-358-7550	117
W01-358-7244	115	W01-358-6935	101	W01-358-7555	117
W01-358-7271	114	W01-358-6940	101	W01-358-7557	117
W01-358-7273	115	W01-358-6941	101	W01-358-7659	114
W01-358-7274	124	W01-358-6943	104	W01-358-7686	101
W01-358-7275	115	W01-358-6944	104	W01-358-7705	114
W01-358-7276	124	W01-358-6945	104	W01-358-7726	98
W01-358-7286	122	W01-358-6946	104	W01-358-7761	122
W01-358-7304	124	W01-358-6947	105	W01-358-7781	118
W01-358-7325	113	W01-358-6948	105	W01-358-7782	118
W01-358-7330	113	W01-358-6949	101	W01-358-7788	102
W01-358-7339	113	W01-358-6960	105	W01-358-7790	113
W01-358-7344	109	W01-358-6962	105	W01-358-7795	102
W01-358-7400	109	W01-358-6994	96	W01-358-7796	123
W01-358-7401	109	W01-358-7001	96	W01-358-7797	123
W01-358-7403	110	W01-358-7008	96	W01-358-7798	123
W01-358-7404	110	W01-358-7009	96	W01-358-7800	123
W01-358-7405	110	W01-358-7011	97	W01-358-7808	124
W01-358-7408	110	W01-358-7025	119	W01-358-7818	124
W01-358-7409	110	W01-358-7043	97	W01-358-7839	125
W01-358-7410	111	W01-358-7057	119	W01-358-7843	125
W01-358-7423	111	W01-358-7093	97	W01-358-7845	125
				W01-358-7846	125
				W01-358-7847	125
				W01-358-7848	126
				W01-358-7850	126
				W01-358-7852	122
				W01-358-7862	126
				W01-358-7872	126
				W01-358-7891	102
				W01-358-7892	102
				W01-358-7897	103
				W01-358-7915	123
				W01-358-7927	115
				W01-358-7949	117
				W01-358-7954	126
				W01-358-7956	127
				W01-358-7990	119
				W01-358-7994	119
				W01-358-7995	119
				W01-358-7996	120
				W01-358-8006	120
				W01-358-8008	120
				W01-358-8010	120
				W01-358-8014	120
				W01-358-8016	121
				W01-358-8018	121
				W01-358-8025	121
				W01-358-8027	121
				W01-358-8030	121
				W01-358-8032	122
				W01-358-8033	122
				W01-358-8038	127
				W01-358-8039	127
				W01-358-8042	127
				W01-358-8043	127
				W01-358-8050	91
				W01-358-8052	91

ALL PARTS  
**INDEX BY ASSEMBLY ORDER NUMBER**

FIRESTONE AON	PAGE NO.	FIRESTONE AON	PAGE NO.
W01-358-8053	91	W01-358-8735	79
W01-358-8091	89	W01-358-8737	77
W01-358-8092	89	W01-358-8738	77
W01-358-8093	89	W01-358-8740	74
W01-358-8109	77	W01-358-8744	75
W01-358-8171	107	W01-358-8746	75
W01-358-8184	19	W01-358-8748	76
W01-358-8195	36	W01-358-8749	76
W01-358-8197	36	W01-358-8752	74
W01-358-8198	36	W01-358-8753	74
W01-358-8203	36	W01-358-8755	75
W01-358-8204	36	W01-358-8760	80
W01-358-8466	63	W01-358-8774	90
W01-358-8478	29	W01-358-8778	81
W01-358-8492	29	W01-358-8779	84
W01-358-8494	62	W01-358-8780	84
W01-358-8500	80	W01-358-8781	84
W01-358-8525	19	W01-358-8782	75
W01-358-8539	80	W01-358-8792	85
W01-358-8591	45	W01-358-8793	90
W01-358-8597	28	W01-358-8796	85
W01-358-8614	78	W01-358-8800	71
W01-358-8616	77	W01-358-8802	40
W01-358-8617	79	W01-358-8803	40
W01-358-8631	74	W01-358-8805	40
W01-358-8637	77	W01-358-8806	40
W01-358-8647	22	W01-358-8810	41
W01-358-8673	76	W01-358-8813	41
W01-358-8708	78	W01-358-8816	41
W01-358-8709	78	W01-358-8817	41
W01-358-8710	79	W01-358-8824	45
W01-358-8713	78	W01-358-8825	45
W01-358-8720	75	W01-358-8828	62
W01-358-8723	74	W01-358-8829	72
W01-358-8724	76	W01-358-8831	64
W01-358-8729	76	W01-358-8842	55

ALL PARTS  
**INDEX BY ASSEMBLY ORDER NUMBER**

FIRESTONE AON	PAGE NO.	FIRESTONE AON	PAGE NO.	FIRESTONE AON	PAGE NO.
W01-358-9010	41	W01-358-9158	86	W01-358-9291	32
W01-358-9017	29	W01-358-9177	83	W01-358-9293	32
W01-358-9026	46	W01-358-9192	57	W01-358-9294	32
W01-358-9031	34	W01-358-9193	47	W01-358-9295	33
W01-358-9033	34	W01-358-9194	47	W01-358-9296	49
W01-358-9036	34	W01-358-9200	80	W01-358-9297	53
W01-358-9039	34	W01-358-9203	57	W01-358-9299	64
W01-358-9049	29	W01-358-9206	81	W01-358-9303	38
W01-358-9053	38	W01-358-9210	47	W01-358-9304	49
W01-358-9056	42	W01-358-9211	48	W01-358-9306	35
W01-358-9059	42	W01-358-9213	48	W01-358-9307	35
W01-358-9069	42	W01-358-9215	81	W01-358-9308	34
W01-358-9070	42	W01-358-9218	81	W01-358-9310	91
W01-358-9071	42	W01-358-9219	48	W01-358-9320	59
W01-358-9073	29	W01-358-9221	83	W01-358-9321	60
W01-358-9078	38	W01-358-9223	48	W01-358-9325	39
W01-358-9082	46	W01-358-9227	48	W01-358-9327	91
W01-358-9083	46	W01-358-9238	58	W01-358-9333	35
W01-358-9092	46	W01-358-9240	58	W01-358-9334	35
W01-358-9093	47	W01-358-9241	58	W01-358-9335	43
W01-358-9096	47	W01-358-9243	58	W01-358-9336	43
W01-358-9101	57	W01-358-9245	58	W01-358-9339	39
W01-358-9105	38	W01-358-9249	68	W01-358-9342	50
W01-358-9106	57	W01-358-9250	70	W01-358-9346	59
W01-358-9118	38	W01-358-9260	64	W01-358-9348	59
W01-358-9121	82	W01-358-9264	88	W01-358-9350	59
W01-358-9122	85	W01-358-9265	61	W01-358-9362	49
W01-358-9130	57	W01-358-9268	63	W01-358-9365	39
W01-358-9134	84	W01-358-9270	71	W01-358-9366	39
W01-358-9135	82	W01-358-9274	68	W01-358-9367	60
W01-358-9138	85	W01-358-9275	69	W01-358-9368	60
W01-358-9141	82	W01-358-9278	64	W01-358-9370	60
W01-358-9144	82	W01-358-9280	83	W01-358-9371	53
W01-358-9148	83	W01-358-9285	30	W01-358-9373	53
W01-358-9149	83	W01-358-9287	53	W01-358-9375	54
W01-358-9156	85	W01-358-9290	30	W01-358-9376	20

ALL PARTS  
**INDEX BY ASSEMBLY ORDER NUMBER**

FIRESTONE AON	PAGE NO.	FIRESTONE AON	PAGE NO.
W01-358-9379	27	W01-358-9529	108
W01-358-9387	21	W01-358-9539	30
W01-358-9391	24	W01-358-9541	26
W01-358-9392	49	W01-358-9547	25
W01-358-9394	59	W01-358-9551	22
W01-358-9401	65	W01-358-9554	28
W01-358-9402	65	W01-358-9560	25
W01-358-9415	24	W01-358-9562	22
W01-358-9421	66	W01-358-9565	27
W01-358-9422	19	W01-358-9566	27
W01-358-9423	66	W01-358-9567	27
W01-358-9439	24	W01-358-9568	28
W01-358-9441	24	W01-358-9578	68
W01-358-9445	21	W01-358-9580	79
W01-358-9447	21	W01-358-9581	79
W01-358-9448	21	W01-358-9582	68
W01-358-9457	21	W01-358-9584	20
W01-358-9459	22	W01-358-9585	44
W01-358-9466	49	W01-358-9586	68
W01-358-9467	43	W01-358-9587	30
W01-358-9469	24	W01-358-9592	30
W01-358-9470	69	W01-358-9595	31
W01-358-9471	69	W01-358-9597	31
W01-358-9472	69	W01-358-9599	31
W01-358-9473	69	W01-358-9616	20
W01-358-9474	50	W01-358-9617	25
W01-358-9477	22	W01-358-9618	26
W01-358-9478	15	W01-358-9619	28
W01-358-9482	43	W01-358-9621	27
W01-358-9484	43	W01-358-9622	26
W01-358-9491	70	W01-358-9625	26
W01-358-9496	50	W01-358-9626	25
W01-358-9501	70	W01-358-9634	63
W01-358-9502	70	W01-358-9640	63
W01-358-9504	70	W01-358-9641	54
W01-358-9507	44	W01-358-9643	64

ALL PARTS  
**INDEX BY ASSEMBLY ORDER NUMBER**

FIRESTONE AON	PAGE NO.	FIRESTONE AON	PAGE NO.	FIRESTONE AON	PAGE NO.
W01-358-9942	52	W02-358-7038	142	W02-358-7116	137
W01-358-9943	52	W02-358-7040	134	W02-358-7132	132
W01-358-9947	52	W02-358-7041	132	W02-358-7139	145
W01-358-9953	32	W02-358-7042	140	W02-358-7149	134
W01-358-9966	50	W02-358-7043	144	W02-358-7150	131
W01-358-9971	52	W02-358-7045	140	W02-358-7151	144
W01-358-9974	53	W02-358-7046	130	W02-358-7200	146
W01-358-9978	44	W02-358-7049	134	W02-358-7201	131
W01-358-9985	86	W02-358-7054	133	W02-358-7204	136
W01-M58-6339	86	W02-358-7055	134	W02-358-7205	143
W01-M58-6348	89	W02-358-7056	140	W02-358-7206	138
W01-M58-7074	62	W02-358-7058	133	W02-358-7208	140
W01-M58-8463	72	W02-358-7059	132	W02-358-7209	135
W01-M58-8468	73	W02-358-7061	139	W02-358-7215	144
W01-M58-8608	80	W02-358-7064	142	W02-358-9901	141
W01-M58-8712	78	W02-358-7070	137	W02-358-9904	141
W01-M58-8775	88	W02-358-7073	135	W26-358-9901	150
W01-M58-8798	89	W02-358-7074	139	W26-358-9902	150
W01-M58-9372	55	W02-358-7075	138	W26-358-9911	151
W01-M58-9656	55	W02-358-7079	130	W26-358-9912	151
W01-M58-9851	60	W02-358-7080	136	W26-358-9913	151
W02-358-4003	141	W02-358-7081	145	W26-358-9933	151
W02-358-7001	131	W02-358-7082	143	WC1-358-3874	92
W02-358-7002	131	W02-358-7083	146	WC1-358-3876	92
W02-358-7007	136	W02-358-7085	136	WC1-358-3900	92
W02-358-7010	133	W02-358-7086	130	WC1-358-3901	92
W02-358-7012	139	W02-358-7087	138	WC1-358-3901	92
W02-358-7014	144	W02-358-7092	145		
W02-358-7017	141	W02-358-7093	145		
W02-358-7018	130	W02-358-7098	133		
W02-358-7024	143	W02-358-7100	132		
W02-358-7025	137	W02-358-7106	135		
W02-358-7031	135	W02-358-7108	142		
W02-358-7035	138	W02-358-7109	142		
W02-358-7036	143	W02-358-7110	146		
W02-358-7037	139	W02-358-7115	137		

# Firestone

## Firestone Industrial Products

### TAKING DEPENDABILITY 100,000 MILES FURTHER

Introducing Firestone's new **INDUSTRY-BEST FIVE YEAR LIMITED WARRANTY**

We reviewed our warranty return rate history, and with rates below 0.02%, this warranty change will not increase distributor exposure for warranty return costs. We recognize the peace of mind our products bring to fleet owners and owner operators across North America, and our new warranty helps you continue to position the Firestone air spring line as the reliability the market needs.

#### AIR SPRING WARRANTY EVALUATION CRITERIA

Firestone air springs are designed to provide years and thousands of miles of trouble-free service. The durability of Firestone air springs is such that they will often outlast other maintenance items on your suspension, such as bushings, shocks, leveling valves, or regulators. Airide springs by Firestone are warranted to be free of material defects and/or workmanship for various periods of time, depending upon the application. Firestone Industrial Products Company offers a complete line of Airide springs, with replacement springs available for virtually every vehicular air suspension system. Since each individual air spring is closely examined and pressure tested at the factory, the vast majority of premature failures and consequent warranty returns are found not to be defective, but fail because of abuse caused by other problems associated with the suspension. Before you install a new air spring, you should carefully examine the old one to determine what caused it to fail. If it was due to a defect in the suspension system, then the new air spring may also fail unless you correct the problem. The information on the next two pages was developed to illustrate the types of failures that may occur, and to assist you in determining the cause and corrective action required.

When applied and maintained properly, Airide™ springs can provide thousands of miles of trouble-free service. Most failures are caused by a lack of suspension maintenance or improper application. This is a guide to common air spring failures that are **not covered by warranty**.

#### MISALIGNMENT

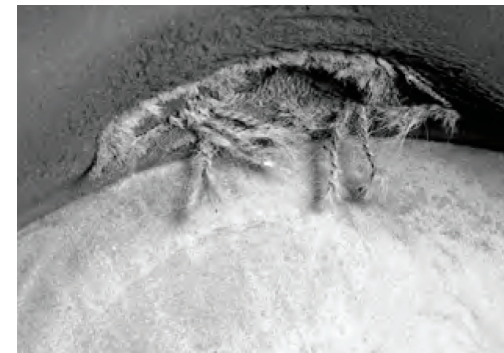

#### Appearance or Condition

- Off-center bumper contact
- Same as abrasion or bottoming out

#### Possible Causes

- Worn bushing
- Improper suspension

#### LOOSE GIRDLE HOOP

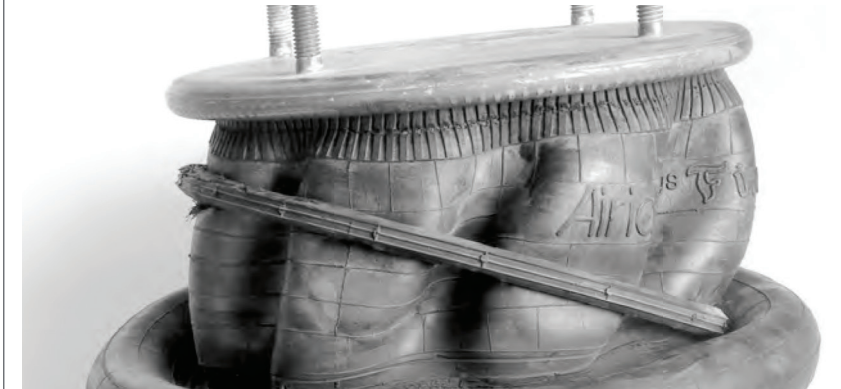

#### Appearance or Condition

- Rubber bellows distorted and girdle hoop torn loose

#### Possible Causes

- Running at extended positions with low air pressure

#### BOTTOMING OUT

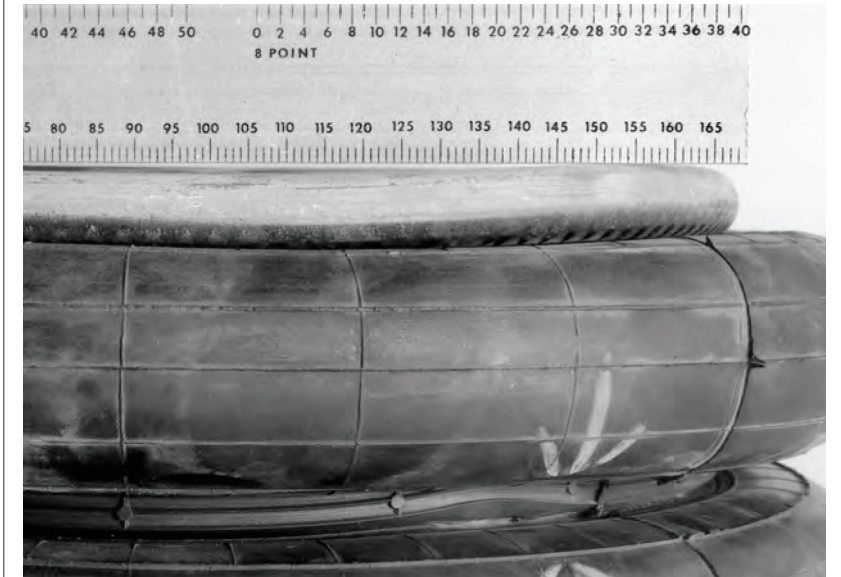

#### Appearance or Condition

- Bead plate concave
- Internal bumper loose
- Hole in girdle hoop area (convoluted)
- Hole in bead plate junction area
- Leaking around blind nuts

#### Possible Causes

- Broken or defective shock absorber
- Defective leveling valve
- Overloaded vehicle
- Pressure regulator set too low
- Wrong air spring (too tall)



**ABRASION**



**Appearance or Condition**

- Hole rubbed into side of bellows
- Hole in bellows area that rolls over piston (reversible sleeve style)

**Possible Causes**

- Structural interference, such as:
  - broken shock
  - loose air line
  - misalignment
  - worn bushings
- No air pressure (reversible sleeve style)
- Foreign material (sand, rocks, etc.)
- Wrong air spring

**CIRCUMFERENTIAL CUTS**



**Appearance or Condition**

- Bellows cut in circle at bead plate junction
- Bellows cut in circle at piston junction (reversible sleeve style)

**Possible Causes**

- High pressure, fully extended for long periods of time
- Impact in compressed position

**OVEREXTENSION**

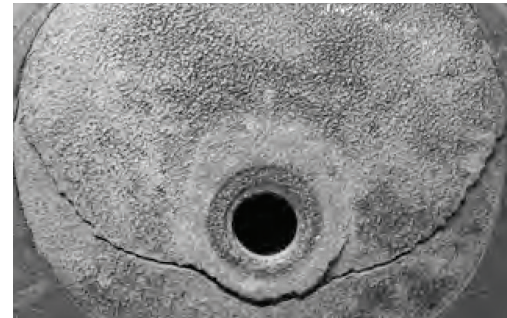
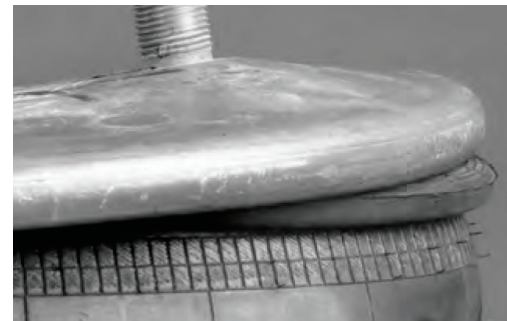

**Appearance or Condition**

- Bead plate convex, especially around blind nuts or studs
- Rubber bellows separated from bead plate
- Leaking at blind nuts or studs
- Leaking at end closure (reversible sleeve)
- Loose girdle hoop on convoluted style

**Possible Causes**

- Broken or wrong shock absorber
- Defective leveling valve
- Ride position too high
- Defective upper stop (lift)
- Wrong air spring (too short)

**Preventive Maintenance Checklist**

Listed below are items that can be checked when the vehicle is in for periodic maintenance. **NEVER ATTEMPT TO SERVICE THE AIR SUSPENSION ON A TRUCK OR TRAILER WITH THE AIR SPRINGS INFLATED.**

- 1** Inspect the O.D. of the air spring. Check for signs of irregular wear or heat cracking.
- 2** Inspect air lines to make sure contact doesn't exist between the air line and the O.D. of the air spring. Air lines can rub a hole in an air spring very quickly.
- 3** Check to see that there is sufficient clearance around the complete circumference of the air spring while at its maximum diameter.
- 4** Inspect the O.D. of the piston for buildup of foreign materials.
- 5** Correct ride height should be maintained. All vehicles with air springs have a specified ride height established by the O.E.M. manufacturer. This height, which is found in your service manual, should be maintained within 1/4". This dimension can be checked with the vehicle loaded or empty.
- 6** Leveling valves (or height control valves) play a large part in ensuring that the total air spring system works as required. Clean, inspect, and replace, if necessary.
- 7** Make sure you have the proper shock absorbers and check for leaking hydraulic oil and worn or broken end connectors. If a broken shock is found, replace it immediately. The shock absorber will normally limit the rebound of an air spring and keeps it from overextending.
- 8** Check the tightness of all mounting hardware (nuts and bolts). If loose, re-torque to the manufacturer's specifications. Do not over-tighten.

**Cleaning**

**APPROVED:** Approved cleaning media are soap and water, methyl alcohol, ethyl alcohol, and isopropyl alcohol. **NON-APPROVED:** Non-approved cleaning media include all organic solvents, open flames, abrasives, and direct pressurized steam cleaning.

The total inspection process described on this page can be done in just a matter of minutes. If you find one of the above conditions exists, please take corrective action to ensure that it is fixed properly. This will save you both time and money over the long run.



# BUILT FOR THE PROS



## THE FIRESTONE ADVANTAGE

Only Firestone delivers the benefits of global innovation to your driveway or fleet. Our Ride-Rite™ air helper springs are precision engineered to fit hundreds of vehicles, including most modern pickup trucks and SUVs. Maximize your vehicle's safe load-carrying capacity, stability, ride quality, and brake effectiveness with Ride-Rite air helper springs, only from Firestone.



Get hooked up today. Order the ultimate air helper springs at [riderite.com](http://riderite.com)

**AIRMOUNT**  
ISOLATORS

**AIRSTROKE**  
ACTUATORS

**AIRPICKER**  
END EFFECTORS

**AIRGRIPPER**  
END EFFECTORS

**MARSH MELLOW**  
SPRINGS



AGRICULTURE



COMMERCIAL LAUNDRY



CONSTRUCTION & MINING



FORESTRY



MATERIAL HANDLING

# INNOVATION — THAT ENABLES — PRODUCTIVITY

Learn more about our global reach at [firestoneip.com](http://firestoneip.com)

# Firestone



---

## COMMERCIAL VEHICLE AIR SPRINGS

---

Use our online air spring identification tool at  
[firestoneip.com/product-search](http://firestoneip.com/product-search)



---

PRIMARY TRUCK  
& TRAILER AXLE

---



---

AUXILIARY / TAG AXLE

---



---

CAB & SEAT

---



---

STEERING AXLE

---

[firestoneip.com](http://firestoneip.com)

800-888-0650

**AIRIDE**  
SPRINGS

FIP-NA-20-A